

EFFECTS OF A REVERSE OSMOSIS-WATER TREATMENT PLANT BRINY
CONCENTRATE DISCHARGED INTO AN OLIGOHALINE ESTUARY.

By Katharine E. Kleber

July, 2010

Director: Roger A. Rulifson, Ph.D.

Department of Biology

Abstract

Reverse Osmosis Water Treatment Plants (RO-WTPs) create potable water and a briny concentrate that must be disposed; often it is discharged into nearby surface waters. Currently, there is no published research to examine effects of this discharge on the ambient environment or on resident and transient biota. One established RO-WTP discharge location was used as a model and compared with a control location within the same embayment and the locations of two RO-WTPs pre-construction. These two plants may discharge up to eight times more concentrate into the estuary. A one-year study used acoustic Doppler current profilers; Hydrolab sondes; a YSI meter; and biological and water collections to profile each location. Water movements at all locations were correlated with wind velocity measured at the USCG-EC weather station and the tide cycle at Mann's Harbor marina. Average velocity was lowest at the established RO-WTP and highest at the two proposed locations in fall 2005. Salinity varied significantly ($p < 0.001$) between the established RO-WTP and one of the proposed locations. From the four locations, we collected 21 species of macroinvertebrates. Location and date were not found to be significant. The effect of briny discharge on two species of macroinvertebrates dissipated beyond 5 m of the diffuser. The macrozooplankton (13 taxa) showed significant differences by date but not location while for the nekton (35 species) showed

significant temporal differences (Spearman's Rho = 0.669) and moderate differences by location (Spearman's Rho = 0.237). There was no evidence that the RO-WTP has a significant impact on either the macrozooplankton or nekton collected. Overall, the biotic communities sampled from the four locations are typical for oligohaline to mesohaline estuaries. There were no significant differences in diversity for any biota collected. It is recommended that 1) data collection related to the discharge continue; 2) measurable indicators of biotic integrity from oligohaline to mesohaline environments be developed; and 3) post-construction samples at the two proposed RO-WTPs continue so as to investigate the effects of increased volume of brine on the local surface water as well as the resident and transient biota.

EFFECTS OF A REVERSE OSMOSIS-WATER TREATMENT PLANT BRINY
CONCENTRATE DISCHARGED INTO AN ESTUARY.

A DISSERTATION
PRESENTED TO
THE FACULTY OF THE DEPARTMENT OF BIOLOGY
EAST CAROLINA UNIVERSITY

IN PARTIAL FULFILLMENT
OF THE REQUIREMENTS FOR THE DEGREE
DOCTOR OF PHILOSPHY
From the
INTERDISCIPLINARY PROGRAM OF BIOLOGICAL SCIENCES

BY
KATHARNINE E. KLEBER

JULY, 2010

© COPYRIGHT 2010

Katharine E. Kleber

EFFECTS OF A REVERSE OSMOSIS-WATER TREATMENT PLANT BRINY
CONCENTRATE DISCHARGED INTO AN ESTUARY.

BY

KATHARINE E. KLEBER

APPROVED BY:

DIRECTOR OF DISSERTATION: _____

Roger A. Rulifson, PhD

COMMITTEE MEMBER: _____

Terri Woods, PhD

COMMITTEE MEMBER: _____

Anthony Overton, PhD

COMMITTEE MEMBER: _____

Enrique Reyes, PhD

CHAIR OF THE DEPARTMENT OF BIOLOGY:

Jeffery McKinnon, PhD

DEAN OF THE GRADUATE SCHOOL:

Paul J. Gemperline, PhD

Dedication

I dedicate this work to my family of origin:

J.R. Kleber

J.J. Kleber

J.A. Kleber and T. Kleber

M.J. Schenk et al.

E.A. Mohrherr et al.

for believing in me and supporting me through everything.

I dedicate this to my family of choice:

F.L. Rush

=^..^=

(And the above)

for all the love and support through the good and bad times.

This is especially dedicated to Mom: J.R. Kleber – for everything.

And the others who have gone before.

Acknowledgements

- First I need to acknowledge F. Rush, without whom this would never have happened.
- A big thank you to Dr. R. Rulifson for helping me to be successful in my endeavors, Dr. T. Woods, Dr. A. Overton, and Dr. E. Reyes for all their help as my committee and all that entails.
- I also need to acknowledge my graduate cohort and undergraduate friends for all their enthusiastic work and support in the processing of samples as well as moral support throughout the last few years.
- Thank you to the counties of Pasquotank and Currituck for providing funding for the project.
- Thank you to the County of Camden for allowing us to use their facilities.
- Thank you to K. Evans, C. Harper, and B. Beltran for all their administrative support.
- Thank you to the Institute for Coastal Science and Policy for providing lab space and equipment.

TABLE OF CONTENTS

ABSTRACT.....	I
TABLE OF FIGURES.....	XII
TABLE OF TABLES	XVIII
CHAPTER 1: INCREASING DEMAND FOR POTABLE WATER	1
BACKGROUND.....	1
DESALINATION.....	6
REFERENCES	10
CHAPTER 2: WATER COLUMN CHEMISTRY OF AN RO-WTP PLUME AND AMBIENT WATERS IN COASTAL NORTH CAROLINA.....	16
ABSTRACT	16
INTRODUCTION	17
STUDY LOCATIONS	22
METHODS	23
<i>Chemical Analysis</i>	23
<i>Water Quality Data</i>	25
<i>Water Movement</i>	26
<i>Sediments</i>	28
RESULTS	29
<i>Chemical Analysis</i>	29
<i>Water Quality Data</i>	31
<i>Water Movement</i>	33

<i>Little River</i>	33
<i>North River</i>	34
<i>CML</i>	36
<i>Sediments</i>	37
DISCUSSION	38
CONCLUSIONS.....	41
ACKNOWLEDGEMENTS.....	42
REFERENCES	43
CHAPTER 3: SEASONAL CHANGES IN BENTHIC COMMUNITY STRUCTURE WITH RESPONSES TO A REVERSE OSMOSIS WATER TREATMENT PLANT IN A NORTH CAROLINA ESTUARY.....	77
ABSTRACT	77
INTRODUCTION	78
STUDY LOCATIONS	83
METHODS	84
<i>General</i>	84
<i>Environmental</i>	85
<i>Camden Model Location (CML)</i>	86
<i>Sediments</i>	87
<i>Date and Location</i>	88
<i>Diversity</i>	89
RESULTS	90
<i>General</i>	90

<i>Environmental</i>	91
<i>Camden Model Location (CML)</i>	93
<i>Sediments</i>	94
<i>Date and Location</i>	94
<i>Diversity</i>	95
DISCUSSION	96
CONCLUSION.....	98
ACKNOWLEDGEMENTS.....	99
REFERENCES	100
CHAPTER 4: SEASONAL PELAGIC COMMUNITY STRUCTURE IN NORTH CAROLINA COASTAL WATERS IN RESPONSE TO A REVERSE OSMOSIS WATER TREATMENT PLANT.....	122
ABSTRACT	122
INTRODUCTION	123
STUDY LOCATIONS	127
METHODS	127
<i>Macroplankton</i>	128
<i>Nekton</i>	128
RESULTS	131
<i>Macroplankton</i>	131
<i>Nekton</i>	132
DISCUSSION	135
CONCLUSIONS.....	137

ACKNOWLEDGMENTS	138
REFERENCES	139
CHAPTER 5: CONCLUSIONS AND RECOMMENDATIONS.....	155
OVERALL CONCLUSIONS.....	159
RECOMMENDATIONS.....	162
REFERENCES	163

Table of Figures

Figure 1-1. Map of the 14 currently operating Water Treatment Plants (WTPs) in the coastal counties of North Carolina with the black stars representing the Reverse Osmosis-WTPs and the gray stars represent other water treatment methods. The two striped squares represent the two proposed RO-WTP	13
Figure 2-1. Map of the 15 currently operating Water Treatment Plants (WTPs) in the coastal counties of North Carolina with the 12 black stars representing the Reverse Osmosis-WTPs and the three gray stars representing other water treatment methods. The two striped squares represent the two proposed RO-WTPs.....	46
Figure 2-2. Average concentrations (ppm = mg/L) of major ions in water samples collected from the Yorktown and Castle Hayne aquifers at the pump houses in 2005, compared to Pasquotank River samples collected by the USGS between 1958 and 1973.....	47
Figure 2-3. Map of study locations; Pasquotank River is the location of the Camden Model Location (CML) and Control location. The mouths of the Little River and North River are the other two sampling locations.	48

Figure 2-4. Details of study locations, Camden Model Location (CML) and Control locations on the Pasquotank River (A), across from the U.S. Coast Guard station at Elizabeth City(USCG-EC), and the Little River (B) and North River (C) locations, including the shallow (S) and deep (D) sites. Figure 2-5 describes the arrangement of the sampling grid at the CML..... 49

Figure 2-5. Arrangement of sampling grid at Camden Model Location (CML). N-S set perpendicular to shore and E-W axis approximated the 2.1-m contour, with the diffuser pipe as the center site. 25m*N site was 1.3 m deep and the 25m*S site was 2.7 m deep. Stream flow was generally from “W” to “E.” Total area was 2,500 m²..... 50

Figure 2-6. Average ammonium concentration (NH₄⁺-N, ppm = mg/L) from the In-Plant sample (far left) compared to all bottom (within 0.5 m of the substrate) 13 sites at the Camden Model Location (CML) July 2005 – June 2006..... 51

Figure 2-7. Comparison the overall average data for the concentrations of sodium (Na⁺), chloride (Cl⁻), Potassium (K⁺), calcium (Ca²⁺), Magnesium (Mg²⁺), and sulfate (SO₄²⁻) ions from the In-Plant samples compared to the 13 sites at the Camden Model Location. 52

Figure 2-8. Average salinity (ppt) measured by YSI model 85 at the four different study locations from July 2005-June 2006. CML=Camden Model Location, CON=Control, LR=Little River, and NR=North River. Asterisks indicate missing data. 53

Figure 2-9. Comparison of surface and bottom conductivities (µS/cm) at the diffuser and the 5m*S site at the Camden Model Location (CML) showing that the water column is usually well-mixed. Asterisk indicates missing data. 54

Figure 2-10. Salinity (chemical analysis) along the N-S axis of the Camden Model Location (CML) and out into the Pasquotank River; 75, 150, 250, and 475 m from the 25m*N site May 2006. Asterisk indicates missing data..... 55

Figure 2-11. Hydrolab data sonde daily temperature (A) and conductivity (B) data from CML, shallow (1.2 m) and deep (2.2 m), bracketing the diffuser, from August 11 through November 21, 2005. Sondes were deployed approximately 0.5 m above the substrate.. 56

Figure 2-12. Hydrolab data sonde daily temperature (A) and conductivity (B) data from the Little River and North River locations, March 31-June 5, 2006. Sondes were deployed approximately 0.5 m above the substrate..... 57

Figure 2-13. Daily mean, maximum and minimum dissolved oxygen (mg/L) values recorded by the Hydrolab data sonde, 0.5 m from the bottom at the 1.2 m contour (A) and at the 2.2 m contour (B) at distances of 7 m from the Camden RO-WTP discharge pipe, August 11 – November 21, 2005. Dashed line at 4.0 mg/L is the U.S. EPA minimum for fish health. Sondes were deployed approximately 0.5 m above the substrate..... 58

Figure 2-14. Daily mean, maximum and minimum dissolved oxygen (DO) (mg/L) values recorded by the Hydrolab data sonde deployed at the 2.2 m contour of the Little River location April 31 – May 18, 2006. Dashed line indicates U.S. EPA recommended minimum DO for fish health. Sondes were deployed approximately 0.5 m above the substrate. 59

Figure 3-1. Map of study locations, shown by the black stars, and the location of Currituck Sound. Pasquotank River is the placement of the Camden Model Location (CML) and Control location; Little River and North River are the other two sampling locations, which are future sites for briny discharge..... 105

Figure 3-2. Details of study locations: Camden Model Location (CML) and Control locations on the Pasquotank River (A), across from the U.S. Coast Guard station at Elizabeth City (USCG-EC), and the Little River (B) and North River (C) locations, including the shallow (S) and deep (D) sites. Figure 3-3 describes the arrangement of the sampling grid at the CML..... 106

Figure 3-3. Arrangement of sampling grid at Camden Model Location (CML). N-S and E-W axis were set with the diffuser pipe as the center site and the central E-W axis approximated the 2.1 m contour. 25m*N site was 1.3 m deep and the 25m*S site was 2.7 m deep. Stream flow was generally from “W” to “E.” Total area was 2,500 m². 107

Figure 3-4. Pie charts showing the percentage of polychaetes, amphipods, and other macroinvertebrates (isopods, mystid shrimp, bivalves, insects, nematodes and decapods) at each sampling location A = Overall composition (n = 15,528); B = Camden Model Location (CML, n = 9,250); C = Control location (n = 799); D = Little River location (n = 4,574); E = North River location (n = 905). 108

Figure 3-5. Average salinity (ppt) measured by YSI model 85 taken at the four different study locations from July 2005-June 2006. CML=Camden Model Location, CON=Control, LR=Little River, and NR=North River. Asterisk indicates missing data. 109

Figure 3-6. Plot of salinity (Na⁺, ppm = mg/L) versus natural log (loge) of the number of individuals (ln(n+1)) for *Leptocheirus plumulosus* and *Marenzelleria viridis* from July 2005-June 2006..... 110

Figure 3-7. Box and whisker plot showing differences in the abundance of *Leptocheirus plumulosus* and *Marenzelleria viridis* in the different *directions* and at the different *distances* from the diffuser pipe..... 111

Figure 3-8. A graphical representation of the statistical findings of *distance*direction* at the Camden Model Location (CML) for *Leptocheirus plumulosus* (A) and *Marenzelleria viridis* (B); "0" indicates numbers of individuals ($\ln(n+1)$) significantly similar to the diffuser site; "+" indicates a significant increase in numbers from the diffuser. 112

Figure 3-9. ANOSIM-cluster analysis indicating no significant differences for date (A, Spearman's $Rho=0.057$) and moderately significant differences for location (B, Spearman's $Rho=0.107$). 113

Figure 3-10. Hierarchical agglomerative cluster tree developed from the ANOSIM analysis of location, including all individuals of all species and all dates, showing a clear grouping pattern of the CML and Control (CON) (1), the North River (NR) (2) and Little River (LR) (3, 4). Data were natural $\log_e (\ln(n+1))$ transformed. Highlighted branches are those with no remaining structure as determined by SIMPROF (similarity profile) testing of each node of the dendrogram..... 114

Figure 3-11. Hill's diversity indices for all macroinvertebrate species from July 2005 through June 2006. A) N_0 =number of species, B) N_1 =number of very abundant species..... 115

Figure 4-1. Map of study locations, shown by the black stars, and the location of Currituck Sound. Pasquotank River is the placement of the Camden Model Location (CML) and Control location; Little River and North River are the other two sampling locations, which are the future sites for briny discharges. 143

Figure 4-2. Details of study locations: Camden Model Location (CML) and Control locations on the Pasquotank River (A), across from the U.S. Coast Guard station at Elizabeth City (USCG-EC), and the Little River (B) and North River (C) locations, including the shallow (S) and deep (D) sites. 144

Figure 4-3. Percentage pie-graphs of the four most numerous macrozooplankton species from the study locations: grass shrimp (*Palaeomonetes* sp.), Harris's mudcrab (*Rhithoropaneopeus harrisii*) zoea, *Leptodora* sp., amphipods (*Gammarus* sp.), and other, including calanoid and cyclopoid copepods, medusa, fish, arthropod-fish lice, Harris's mudcrab megalope, clam, isopod, mysid shrimp, mussel, and penaeid shrimp. A. Overall, B. Camden Model Location (CML), C. Control, D. Little River, and E. North River..... 145

Figure 4-4. ANOSIM analysis for zooplankton taxa data indicating significant differences for date (A, Spearman's Rho = 0.724) and no significant differences for location (B, Spearman's Rho = -0.064, line is not visible under the data). 146

Figure 4-5. Hill's *NO* (A., number of species) and *NI* (B., number of very abundant species) of zooplankton sampled over the sampling dates, 2005-2006. CML=Camden Model Location. 147

Figure 4-6. Percentage pie-graphs of the four most numerous nekton species from the study locations. A. Overall, B. Camden Model Location (CML), C. Control, D. Little River, and E. North River. 148

Figure 4-7. ANOSIM analysis of fish species data indicating significant differences for date (A, Spearman's Rho = 0.669) and moderately significant differences for location (B, Spearman's Rho = 0.237). 149

Figure 4-8. Hill's *NO* (A., number of species) and *NI* (B., number of very abundant species) of fish sampled over the sampling dates, 2005-2006. Camden=Camden Model Location. 150

Figure 4-9. Average salinity (ppt) from YSI model 85 taken at the four different study locations from July 2005-June 2006. CML=Camden Model Location, CON=Control, LR=Little River, and NR=North River. Asterisks indicate missing data. 151

Figure 5-1. Map of study locations: Camden Model Location and Control location (Pasquotank River), the mouth of the Little River (Pasquotank County), and the mouth of the North River (Currituck County), which are the future sites for briny discharge. 164

Figure 5-2. Arrangement of sampling grid at Camden Model Location (CML). N-S and E-W axis were set with the diffuser pipe as the center site and the central E-W axis approximated the 2.1 m contour. 25m*N site was 1.3 m deep and the 25m*S site was 2.7 m deep. Stream flow was generally from “W” to “E.” Total area was 2,500 m². 165

Table of Tables

Table 1-1. Relationship of geologic and hydrographic units in the North Carolina central coastal plain (NCCCP). Modified from NC Division of Water Resources Ground Water Management Section 2005. Modified from www.crwr.utexas.edu. 14

Table 1-2. Current and proposed water treatment plants in the state of North Carolina including County in which the plant is located, operation phase, source aquifer, production and discharge rates (cubic meters per day (CMD) and millions of gallons per day (MGD)), receiving body of water and if a preconstruction study was completed. "*"= present study. 15

Table 2-1. Twelve current and two proposed Reverse Osmosis Water Treatment Plants (RO-WTPs) in the state of North Carolina including the County in which the plant is located, operation phase, source aquifer, production and discharge rates (cubic meters per day

(CMD) and millions of gallons per day (MGD)), receiving body of water, and if a preconstruction study was completed. "#"= Proposed RO-WTPs; “-“ = data not available. 60

Table 2-2. Relationship of geologic and hydrographic units in the North Carolina central coastal plain (NCCCP). Modified from NC Division of Water Resources Ground Water Management Section 2005. Modified from www.crwr.utexas.edu. 61

Table 2-3. Two-tailed Student’s t-test, $\alpha = 0.05$, comparing ammonia concentrations from the In-Plant samples compared to the average of the 13 water samples taken within 0.5 m of the bottom at the Camden Model Location (CML), Control (CON), Little River (LR), and the North River locations, July 2005 – June 2006. Asterisk indicates statistical significance. 62

Table 2-4. Two-tailed Student’s t-test, $\alpha = 0.05$, comparing salinity (chemical analysis) from the In-Plant samples to the average of the 13 water samples collected within 0.5 m of the bottom at the Camden Model Location (CML), Control (CON), Little River (LR), and the North River locations, July 2005 – June 2006. Asterisk indicates statistical significance. 63

Table 2-5. Ratios (maximum, minimum and average) of calcium (Ca^{2+}) to sodium (Na^+) ions from all study locations: Camden Model Location (CML), Control (CON), Little River (LR), and North River (NR), between July 2005 and June 2006. 64

Table 2-6. Significant ($p \leq 0.05$) Pearson correlation coefficients of the net distance of water movement (m/hr) by net movement direction and vertical position (surface, midwater, and bottom) recorded by the Little River Deep (2.1 m) ADCP profiler, weather recorded at the Elizabeth City Coast Guard Station (EC), and the tide data at Mann’s Harbor (MH)

marina for dates indicated. N = number of water movement observations in the direction indicated. Bottom = bins 1-5 (0.31-0.71 m); Midwater = bins 6-11 (0.81-1.31 m); Surface = bins 12-16 (1.41-1.81 m)..... 65

Table 2-7. Significant ($p \leq 0.05$) Pearson correlation coefficients of the net distance of water movement (m/hr) by net movement direction and vertical position (surface and bottom) recorded by the Little River Shallow (1.2 m) ADCP profiler, weather recorded at the Elizabeth City Coast Guard Station (EC), and the tide data at Mann’s Harbor (MH) marina for dates indicated. N = number of water movement observations in the direction indicated. Bottom = bins 1-5 (0.31-0.71 m); Surface = bins 6-11 (0.81-1.41 m)..... 67

Table 2-8. Significant ($p \leq 0.05$) Pearson correlation coefficients of the net distance of water movement (m/hr) by net movement direction and vertical position (surface, midwater, and bottom) recorded by the North River Deep (2.1 m) ADCP profiler, weather recorded at the Elizabeth City Coast Guard Station (EC), and the tide data at Mann’s Harbor (MH) marina for dates indicated. N = number of water movement observations in the direction indicated. Bottom = bins 1-5 (0.31-0.71 m); Midwater = bins 6-11 (0.81-1.31 m); Surface = bins 12-16 (1.41-1.81 m)..... 68

Table 2-9. Significant ($p \leq 0.05$) Pearson correlation coefficients of the net distance of water movement (m/hr) by net movement direction by vertical position (surface and bottom) recorded by the North River Shallow (1.2 m) ADCP profiler, weather recorded at the Elizabeth City Coast Guard Station (EC), and the tide data at Mann’s Harbor (MH) marina for dates indicated. N = number of water movement observations in the direction indicated. Bottom = bins 1-5 (0.31-0.71 m); Surface = bins 6-11 (0.81-1.41 m)..... 70

Table 2-10. Significant ($p \leq 0.05$) Pearson correlation coefficients of the net distance of water movement (m/hr) by net movement direction by vertical position (surface, midwater, and bottom) recorded by the Camden Model Location Deep (2.1 m) ADCP profiler, weather recorded at the Elizabeth City Coast Guard Station (EC), and the tide data at Mann's Harbor (MH) marina for dates indicated. N = number of water movement observations in the direction indicated. Bottom = bins 1-5 (0.31-0.71 m); Midwater = bins 6-11 (0.81-1.31 m); Surface = bins 12-16 (1.41-1.81 m). 72

Table 2-11. Significant ($p \leq 0.05$) Pearson correlation coefficients of the net distance of water movement (m/hr) by net movement direction by vertical position (surface and bottom) recorded by the Camden Model Location Shallow (1.2 m) ADCP profiler, weather recorded at the Elizabeth City Coast Guard Station (EC), and the tide data at Mann's Harbor (MH) marina for dates indicated. N = number of water movement observations in the direction indicated. Bottom = bins 1-5 (0.31-0.71 m); Surface = bins 6-11 (0.81-1.41 m). 74

Table 2-12. The average sediment composition of gravel, sand, silt, clay and organic matter (LOI, Loss on Ignition) found at Camden Model Location (CML), Control, Little River and North River study locations. Numbers for Little River and North River are averaged over both study depths. All numbers are given as percentages. Gravel (coarse fraction) consisted of a combination of shells, sand clumps and organic matter; the * indicates shells only. The ** indicates that the coarse fraction contained sand clumps only. 76

Table 3-1. Current and proposed water treatment plants (WTP) in the state of North Carolina including County in which the plant is located, operation phase, source aquifer, production and discharge rates (cubic meters per day (CMD) and millions of gallons per

day (MGD)), receiving body of water and if a preconstruction study was completed. "*" = present study; "***" = Non-Reverse Osmosis WTP..... 116

Table 3-2. Presence, absence, classification and number of macroinvertebrate taxa found from the four study locations in Albemarle Sound, North Carolina from July 2005 through June 2006. "+" = present; "-" = absent from samples..... 117

Table 3-3. Water quality variables temperature (°C), dissolved oxygen (mg/L and percent saturation), temperature-corrected conductivity (µS), and salinity (ppt) taken with a YSI-85 hand-held meter. Data shown are only from measurements recorded from just above the bottom at all sites, and for the entire month at the Camden Model Location..... 118

Table 3-4. Statistical results comparing the salinity of the In-Plant sample just prior to discharge and the salinity of the receiving waters at the study locations determined by two-tailed Student's t-test; $\alpha=0.05$: Camden Model Location (CML), Control (CON), Little River (LR) and North River (NR). All values are Student's two-tailed p-value, $\alpha=0.05$. Asterisk indicates statistical significance..... 119

Table 3-5. Statistical results for the variables of *distance*, *direction* and *distance*direction* effects for *Leptocheirus plumulosus* and *Marenzelleria viridis* at the Camden Model Location. Results were determined using a two-tailed Student's t-test, $\alpha=0.05$. A single asterisk is used to indicate the variable *distance*direction*, i.e.; 5m*E. An asterisk associated with the results indicates a value significantly different from the value at the diffuser..... 120

Table 3-6. The average sediment composition (%) of gravel, sand, silt, clay and organic matter (LOI, Loss on Ignition) found at Camden Model Location (CML), Control, Little River and North River study locations. Numbers for Little River and North River were

averaged over both study depths. Gravel consisted of a combination of shells and organic matter; the single asterisk indicates shells only. The double asterisk indicates that the coarse fraction contained sand clumps only. 121

Table 4-1. Common and scientific names of macroplankton caught at all four sampling locations from July 2005-June 2006. CML=Camden Model Location, CON=Control, LR=Little River, and NR=North River locations. "+"= species present; "0"= species not present. *Mudcrab zoea and megalopa were counted as one taxa. 152

Table 4-2. Common and scientific names of nekton caught at all four sampling locations from July 2005-June 2006. CML is the Camden Model Location, CON is the Control, LR is the Little River and NR is the North River locations. "+"= species present; "0"= species not present. Associations are indicated by B=brackish, F=fresh, M=marine, and D=diadromous. 153

Table 4-3. Statistical results comparing the salinity of the In-Plant sample just prior to discharge and the salinity of the receiving waters at the study locations determined by two-tailed Student's t-test; $\alpha=0.05$: Camden Model Location (CML), Control (CON), Little River (LR) and North River (NR). All values are Student's two-tailed p-value, $\alpha=0.05$. Asterisk indicates statistical significance..... 154

CHAPTER 1: INCREASING DEMAND FOR POTABLE WATER

Katharine E. Kleber

Interdisciplinary Program in Biological Sciences

Department of Biology

East Carolina University, Greenville, NC 27858

Background

Saline water defined as >1.0 ppt by the USGS (2007), represents 97% of the water available on the Earth; the remaining 3% is considered freshwater. The United States Environmental Protection Agency (USEPA) has set a recommended drinking water standard for salts of <0.5 ppt, while anything greater than about 3.0 ppt is too salty to drink (USGS 2007). The distribution of freshwater is 68.5% in ice caps, 31.2% as groundwater, and 0.3% as surface waters (Dennehy 2004).

With the Earth's human population reaching 6.6 billion in early 2007, and with an estimate that the population will reach 9.4 billion by 2050 (United States Census Bureau 2007), there is a growing need for access to potable water, not only for human consumption but also for agriculture and industrial uses. With only 0.3% of the Earth's water available as surface waters, world-wide access to potable waters is a critical and growing problem. The UNESCO world water development report (2003) predicts that by the year 2025, more than 50% of the nations in the world will be facing water shortages.

Many surface-water resources have multiple claims and agreements for use (i.e., withdrawals) as well as natural demands that make them unsuitable for further development. This is true especially in the southwestern USA; for example, the over-

commitments for waters of the Colorado River (Reisner 1993). Some surface waters are not suitable for consumption as defined by drinking water standards for pollution or contaminants.

Both point-source and non-point-source pollution create more problems in surface waters. Runoff from agriculture and urban fertilizer applications often causes increases in nitrate and phosphate concentrations, making drinking of this water unsuitable and inadvisable for at-risk members of the population. These nutrient additions contribute to algal blooms, especially blue-green algae, which often imparts an unappealing taste to the water (Chau 2006; United States Global Change Resource Program 2007).

Dennehy (2004) reported that the United States source of water withdrawals in 2000 was mostly from surface waters. In 2000, California and Texas withdrew 20,000-40,000 million gallons per day (MGD) (75.7-151.4 million cubic meters per day [MCMD]) of fresh surface waters (USGS 2007). During the same year, saline withdrawals, mostly from the ocean, matched freshwater withdrawals with California, Florida and Maryland combined. Most of these saline water withdrawals cooled electricity generators in power plants, but not all. In 2002, 35% of the U.S. population was dependant on the use of treated groundwater as the primary source of public waters, and more than 15% of the population was dependant on self-supplied ground water (Dennehy 2004). North Carolina, in this same period, withdrew between 2,000-10,000 MGD (7.57-37.85 MCMD) of freshwater and >2,000 MGD (7.57 MCMD) of saline water (USGS 2007).

Much of this increased demand for potable water is occurring because of a shift in the U.S. population. From 1990-2000, the populations of Nevada and Arizona increased at more than three times the national rate of 13.2%. In terms of actual numbers, Nevada's

population grew by more than 500,000 people while Arizona's grew by more than 1 million. Idaho, Utah, Colorado and Georgia have seen increases of at least two times the national rate adding more than 1 million people, while 12 other states, including North Carolina, have seen a 13-26% increase (United States Census Bureau 2007). Most of these states are in the southern and western parts of the United States. These southwestern States are deserts, arid areas which receive less than 25 cm of rain annually and by definition considered to have limited access to potable water (The American Heritage Dictionary 2006).

The study described herein is interested specifically in the water issues of coastal North Carolina, which ranks 9th in actual population growth. The North Carolina population increased 21.6% from 1990 to 2000, which equates to more than 1 million people (United States Census Bureau 2007), and grew an additional estimated 7.9% from 2000-2005 (United States Census Bureau 2007). With this increase in population, there is a corresponding increase in water demand. More than half of the estimated increase in North Carolina is occurring in the 21 counties east of I-95 (United States Census Bureau 2007) including the barrier islands (Outer Banks), already stressed by limited access to fresh water resources.

The eastern counties of North Carolina have access to surface waters, but these waters are acidic "blackwaters" due mainly to the presence of tannins and lignins, a byproduct of decaying vegetation, most often, *Taxodium* sp. (Bricaud et al. 1981; Hernes and Hedges 2004; Gallegos 2005; Dobberfuhr 2007). Decaying *Taxodium* imparts the characteristic dark brown color that gives "blackwaters" the colloquial name and these organics would likely exceed the aesthetic standards for total dissolved solids (TDS) (<500

mg/L, U.S. EPA 2006). The total removal of these organics would require ultra filtration, which is cost prohibitive at this time (Hightower 2003).

Aquifers often are the only remaining resource for creation of potable water. In North Carolina, there are eight major aquifers (Huffman 1996) (Table 1-1). Aquifers are areas of hydrologically connected porous materials separated by clay-rich confining sediments. All eight major aquifers underlie the North Carolina Coastal Plain. Listed from deepest to shallowest they are: the Lower and Upper Cape Fear, Black Creek, Peedee, Castle Hayne, Yorktown, Surficial and the Fractured Bedrock aquifers (Table 1-1). The Fractured Bedrock aquifer primarily serves the western coastal plain and western North Carolina and is not a primary aquifer used in eastern North Carolina.

The Surficial aquifer is the closest to the surface throughout the State and is the source for many individual home wells. This aquifer is the most susceptible to surface contamination from urban and agricultural runoff and also is the most sensitive to drought conditions (Huffman 1996). Many of the communities in the Outer Banks use the Surficial aquifer as the main source of potable water, with many residents using self-supplied wells. The Outer Banks Surficial aquifer is especially susceptible to drought and contamination as well as saltwater intrusion from increased pumping. Also there is the high probability of ocean waters overwashing the islands and contaminating the aquifer from the surface, creating poor water quality (N.C. Division of Water Resources 2007). With growing resident and transient populations on the Outer Banks, the Surficial aquifer is being further stressed leading to increased saltwater intrusion and the need to develop alternative water sources (Outer Banks Hydrology Management Committee 2005).

The Lower and Upper Cape Fear, Black Creek, Peedee, Castle Hayne and Yorktown aquifers are the principal coastal aquifers and are inter-connected. This connectivity can lead to both near and far-reaching depressions in the equipotential surface because of large local water withdrawals (Huffman 1996). Unlimited withdrawals cause problems when the aquifers are not able to recharge (i.e., replace the water that is removed) rapidly enough and can depress water levels far distant from the source of withdrawal, even affecting the inland reach of brackish and salty waters (Huffman 1996).

The Yorktown aquifer serves much of the northern Coastal Plain and has been the main source of water for Roanoke Island, Kill Devil Hills and Elizabeth City, yielding 22,000-130,000 GPD (86-490 CMD) (North Carolina Division of Water Resources 2007). The Castle Hayne is the most productive aquifer in North Carolina with yields ranging from 288,000-720,000 GPD (1,100-2,700 CMD) and sometimes exceeding 2,880,000 GPD (10,900 CMD) (North Carolina Division of Water Resources 2007). The remaining aquifers are not as productive, but tend to have yields between 288,000-576,000 GPD (1,100-2,200 CMD). The western portion of the Castle Hayne aquifer is fresh water, while the eastern part is salty with a fairly wide transition (brackish) zone in between. The portion of the Castle Hayne that serves eastern Albemarle and Currituck sounds is considered brackish (> 0.5 and < 30.0 ppt) to salty (> 30 ppt) (Giese et al. 1979) (Figure 1-1). Desalination of this water is required to make it potable.

The issues of saltwater intrusion into the Surficial aquifer and restrictions on the use of local surface water have led to changing water laws in eastern North Carolina. Historically, North Carolina has managed surface and ground water resources as separate entities (Polk et al. 2007). With surface water recharging ground water and the

connectivity of ground waters in North Carolina, there cannot be such a separation. Polk et al. (2007) note that there are different regulatory agencies that oversee quality and quantity of waters in North Carolina. We must consider both quality and quantity together to manage the resource effectively.

Desalination

Desalination is the creation of potable water from a brackish or saline source and has become a much needed supplement to domestic water resources. It also offers treatment for surface waters that have become saline due to upstream usage (Alles 2006). In the southwest U.S., where surface waters have become increasingly saline because of agricultural runoff and urban uses (Hoffman et al. 1977; Westcot 1997; Atkins 2010), water managers use desalination to produce potable water for use further downstream. Desalination satisfies water quality standards based on total maximum daily load, as well. This treatment of the domestic waters helps meet water quality standards (Hightower 2003).

Desalination is now more cost effective than finding and developing new fresh water sources (Hightower 2003). The cost of desalination in North Carolina currently is USD \$3.62/1000 gallons (3.8 m³), which includes the construction debt and salaries, while specific operational costs (chemicals, power and replacement membranes) accounts for \$0.62 of the total (Ed Lawler, Hobbs, Upchurch, & Associates, personal communication 2007). Concerns with the continued development of desalination include the salinity of source waters, location of the treatment plant with respect to source, increasing efficiency of recovery thereby decreasing costs, and environmental issues such as the disposal of the

briny concentrate (Hightower 2003; Holladay 2004). The anticipated recovery of fresh water for North Carolina plants is about 75% (Ed Lawler, Hobbs, Upchurch, & Associates, personal communication 2007). One way to reduce cost and increase efficiency is through combining intake and outfall with coastal power plants and recapture of once-through brine (Hightower 2003). Small plants increase energy cost, cost of disposal, and the costs associated with water pumping. The current efficiency of desalination is between 60-85%, which means that currently 15-40% of possible usable water is disposed with the briny concentrate (Hightower 2003).

Two of the most common methods for creating potable water from salty (or brackish) water are distillation and reverse osmosis, both of which produce a briny concentrate waste. Distillation involves vaporizing the source water and collecting the purified water as it condenses (Holladay 2004). Combining other water treatments with distillation can decrease costs and increase efficiency. Reverse osmosis uses pressure to force brackish water through a semi-permeable membrane, which permits the passage of water molecules while restricting and concentrating larger molecules (Holladay 2004). Often the concentrate is recycled to extract even more potable water.

In the United States, the National Pollution Discharge Elimination System (NPDES) is the current standard of permitting for aqueous discharges. The NPDES creates enforceable standards for concentration, duration, and frequencies of pollution discharge from point sources. EPA's National Ambient Water Quality criteria described in the Clean Water Act of 1969 are the basis of these standards. EPA regulations state that the rate of discharge should allow the receiving system to assimilate the discharge without negative effects. This rate is the critical load, and for aquatic systems this rate is termed the Total

Maximum Daily Load (TMDL). Defining the receiving system and a baseline that is easily measurable is a way to establish the load and rate information. Sensitivity must be such that changes may be easily recognized.

The problem with using this system of critical load or TMDL is that the EPA does not define the briny concentrate produced by RO-WTPs as a pollutant when discharged into brackish or blackwater areas, such as those found in coastal North Carolina (Water Quality Concerns 2006). Also, the concentrations and proportions of salts are different than that in the receiving waters (Rulifson et al. 2006). Differences in temperature and dissolved oxygen between the source waters and the receiving waters also are a concern (Rinne 1971; Holladay 2004; Water Quality Concerns 2006). There are also no Federal or State regulations for these RO-WTPs and current assessments are on a case-by-case basis. Until now, North Carolina studies of briny concentrate effects on the receiving environment have focused on local drawl-down effects and plume studies to judge the affected distance and rates of mixing with receiving waters under prevailing water conditions, using the Cornell Mixing Zone Expert System (CORMIX) model (Rulifson et al 2006; CORMIX 2007). These studies have reported findings of no significant environmental impact and permits have been granted with no further study (R.M. Towill Corporation 1998; Wilson Okamoto and Associates 1999). There has been no research to examine the effects of the briny concentrate on resident and transitory biota.

In the United States, the concentrate created by desalination may be disposed by brine “mining” to retrieve useful salts and metals from the concentrate (Hightower 2003; Burnett and Veil 2004). Other options have included: injection into oil wells (Hightower 2003; Burnett and Veil 2004); application to land (Hightower 2003); discharge through

dunes into a receiving body of water (Campbell et al. 2003); and discharge directly into a water column (Hightower 2003).

Currently there are 12 operating RO-WTPs discharging into North Carolina sounds with a combined briny concentrate discharge of approximately 4.3 MGD (16,000 CMD) (Rulifson et al. 2006). Albemarle Sound is also the location of two proposed RO-WTPs (Figure 1). These two proposed plants will have a combined concentrate discharge approximately equal to that of all the other plants along the North Carolina coast (Table 2). The planned disposal is into the surface waters of Albemarle Sound.

The main goal of this study is to gain information on the impact and interaction of briny concentrate discharge with the surrounding environment including resident and transient biota. Objectives include a) investigating the possible differences in the chemical characteristics of the receiving waters; b) assessing the possible differences to the benthic macroinvertebrates in relationship to the discharge; c) assessing the effects of the discharge on the local macroplankton and nekton community; and d) assessing possible differences in diversity between the existing RO-WTP as well as the two proposed locations.

The set of observations made in this study will create a baseline of information for continued research into these interactions in oligohaline estuarine systems.

References

- Alles, D.L. 2006. The delta of the Colorado River. <http://fire.biol.wvu.edu/trent/alles/TheDelta.pdf> Last updated 08/06/06. Accessed July 17, 2010.
- American Heritage Dictionary, The. 2006. Houghton Mifflin Company, Boston, MA.
- Atkins, W.A. 2010. Colorado River Basin. <http://www.waterencyclopedia.com/Ce-Cr/Colorado-River-Basin.html>. Accessed July 17, 2010.
- Bricaud, A., A. Morel, and L. Prieur. 1981. Absorption by dissolved organic matter of the sea (yellow substance) in the UV and visible domains. *Limnology and Oceanography* 26:43–53.
- Campbell, R.L., J. Hanion, F. Seamon, and A.T. Jones. 2003. Retrofit of a California coastal desalination plant: add technology, lower costs. *Oceans 2003 Proceedings* 1:246-248.
- Chau, K.W. 2006. Integrated water quality management in Tolo Harbour, Hong Kong: a case study. *Journal of Cleaner Production*. (In press). 5pp.
- CORMIX. 2009. About CORMIX. <http://www.cormix.info/aboutcormix.php>. Accessed July 17, 2010.
- Dennahy, K.F. 2004. National perspective on saline aquifers. *New Mexico Water Resources Research Institute* September 2004.
- Dobberfuhl, D.R. 2007. Light limiting thresholds for submerged aquatic vegetation in a blackwater river. *Aquatic Botany* 86:346-352.
- Gallegos, C.L. 2005. Optical water quality of a blackwater river estuary: the Lower St. Johns River, Florida, USA. *Estuarine, Coastal and Shelf Science* 63:57-72.
- Giese, G.L., H.B. Wilder, and G.G. Parker Jr. 1979. Hydrology of major estuaries and sounds of North Carolina. U.S. Geological Survey. *Water Resources Investigations* 79-46. 175 p.
- Hernes, P.J., and J.I. Hedges. 2004. Tannin signatures of barks, needles, leaves, cones, and wood at the molecular level. *Geochimica et Cosmochimica Acta* 68: 1293-1307.
- Hightower, M. 2003. Desalination of inland brackish water: issues and concerns. *Southwest Hydrology*. May/June issue 2003:18-19.

- Hoffman, G.J., C. Dirksen, R.D. Ingvalson, E.V. Maas, J.D. Oster, S.L. Rawlins, J.D. Rhoades and J. Van Schilfgaarde. 1977. Minimizing salt in drain water by irrigation management: design and initial results of Arizona field studies. *Agricultural Water Management* 1: 233-252.
- Holladay, T. 2004. House Research Organization, Texas House of Representatives. Interim News. August 20, 2004. Number: 78-8.
- Huffman, R.L. 1996. Ground water in the coastal plain of North Carolina. *Water Quality & Waste Management*. North Carolina Cooperative Extension Service. Publication Number AG-450. 4pp.
- NC Division of Water Resources. 2010. North Carolina Aquifers. North Carolina Department of Environment and Natural Resources. Division of Water Quality. http://www.ncwater.org/Education_and_Technical_Assistance/Ground_Water/AquiferCharacteristics/. Accessed July 17, 2010.
- Outer Banks Hydrology Management Committee. 2005. Findings Report, Outer Banks Hydrology Committee. November 3, 2005. 44p.
- Polk, E., L. Kleczek, L. Olander, and B. Holman. 2007. The future of water in North Carolina: strategies for sustaining abundant and clean water. Nicholas Institute for Environmental Policy Solutions. A Pre-conference Paper, The Future of Water conference, March 1, 2007.
- Reisner, M. 1993. *Cadillac Desert: The American West and its disappearing water*, revised edition. Penguin. 608pp.
- Rinne, W. 1971. Waste brine disposal from coastal desalination plants. *Oceans* 3:325-238.
- R.M. Towill Corporation. 1998. Final environmental assessment Waialae west well, Waialae, Honolulu, Oahu, Hawaii. TMK: 3-3-14:16. R.M. Towill Corporation, Honolulu, Hawaii. 98 p.
- Rulifson, R.A., T.L. Woods, and K.E. Kleber. 2006. Environmental assessment of the Currituck County reverse osmosis water treatment plant discharge site, Albemarle Sound, North Carolina: Final Report. In support of Environmental Assessment Report for Currituck County, Hobbs, Upchurch & Associates, P.A. East Carolina University ICMR Contribution Number 06-04. 129 p.
- United States Census Bureau. 2007. US Census Bureau. Available: <http://www.census.gov/ipc/www/idb/>. Accessed July 17, 2010.

- United States Geological Survey. 2007. USGS. Available: <http://www.usgs.gov/>. Accessed July 17, 2010.
- United States Global Change Resource Program. 2007. US GCRP. Available: <http://www.globalchange.gov/>. Accessed July 17, 2010.
- U.S. Environmental Protection Agency. 2006. Secondary Drinking Water Regulations: Guidance for Nuisance Chemicals. <http://www.epa.gov/safewater/consumer/2ndstandards.html>. Accessed July 17, 2010
- UNESCO. 2003. Water for the people. Executive Summary. The United Nations World Water Development Report. Available: <http://unesdoc.unesco.org/images/0012/001295/129556e.pdf>. Accessed July 17, 2010.
- Water Quality Concerns. 2006. Water quality improvements in river herring management areas. General Statutes of North Carolina. February 16, 2006.
- Westcot, D.W. 1997. Chapter 2 – Drainage water quality. Madramootoo, C.A., W.R. Johnston, and L.W. Willardson editors in Management of agricultural drainage water quality. International commission on irrigation and drainage. Food and Agriculture Organization of the United Nations Rome, 1997. Available: <http://www.fao.org/docrep/w7224e/w7224e00.htm#Contents> (Chapter 2). Accessed July 17, 2010.
- Wilson Okamoto and Associates, Inc. 1999. Final environmental assessment and finding of no significant impact (FONSI) Haleiwa well II exploratory well site. Waialua, Oahu, Hawaii. Prepared by Wilson Okamoto and Associates, Engineers and Planners, Honolulu, Hawaii. 100 p.

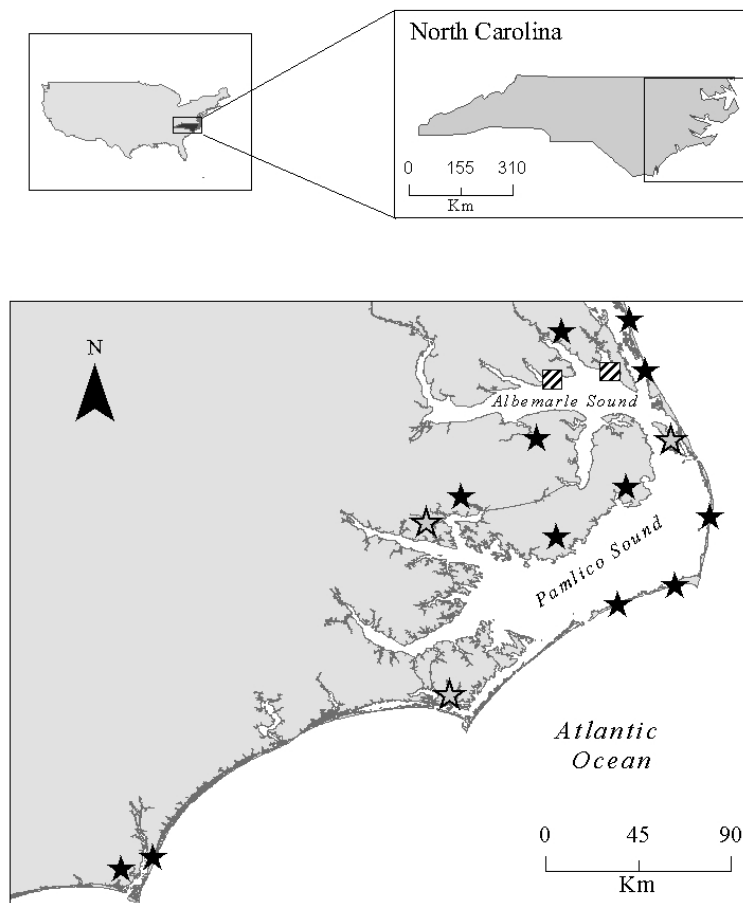

Figure 1-1. Map of the 14 currently operating Water Treatment Plants (WTPs) in the coastal counties of North Carolina with the black stars representing the Reverse Osmosis-WTPs and the gray stars represent other water treatment methods. The two striped squares represent the two proposed RO-WTP

Table 1-1. Relationship of geologic and hydrographic units in the North Carolina central coastal plain (NCCCP). Modified from NC Division of Water Resources Ground Water Management Section 2005. Modified from www.crrw.utexas.edu.

North Carolina Central Coastal Plain Geologic Units			North Carolina Central Coastal Plain Hydrologic Units
System	Series	Formation	Aquifers and Confining Units
Quaternary	Holocene	Undifferentiated	Surficial Aquifer
	Pleistocene		
Tertiary	Pliocene	Yorktown	Yorktown Confining Unit
			Yorktown Aquifer
	Middle Eocene	Castle Hayne Formation	Castle Hayne Confining Unit
			Castle Hayne Aquifer
	Upper Paleocene	Beaufort Formation	Beaufort Confining Unit
			Beaufort Aquifer
Cretaceous		Peedee Formation	Peedee Confining Unit
			Peedee Aquifer
		Black Creek Formation	Black Creek Confining Unit
			Black Creek Aquifer
	Cape Fear Formation	Upper Cape Fear Confining Unit	Upper Cape Fear Aquifer
			Lower Cape Fear Confining Unit
		Lower Cape Fear Aquifer	

Table 1-2. Twelve current and two proposed Reverse Osmosis Water Treatment Plants (RO-WTPs) in the state of North Carolina including the County in which the plant is located, operation phase, source aquifer, production and discharge rates (cubic meters per day (CMD) and millions of gallons per day (MGD)), receiving body of water, and if a preconstruction study was completed. "#" indicates proposed RO-WTPs; "--" indicates data are not available.

County	Operation phase	Aquifer(s)	Production		Discharge		Discharge water body	Pre-construction study?
			CMD	MGD	CMD	MGD		
Brunswick	Online	Castle Hayne	583	0.15	227	0.06	Infiltration lagoons (non-discharge)	Yes
New Hanover	-	-	-	-	-	-	-	-
Ocracoke	Online	Castle Hayne	1,961	0.52	1,037	0.27	Pamlico Sound	Yes
# Pasquotank	Proposed	Castle Hayne	18,927	5.00	6,322	1.67	Albemarle Sound	Yes
Tyrrell	Online	Castle Hayne	1,628	0.43	379	0.10	Albemarle Sound	Plume Study
# Currituck	Proposed	Yorktown	18,927	5.00	6,322	1.67	Albemarle Sound	Yes
	Online	Yorktown	3,785	1.00	1,181	0.32	Atlantic Ocean	Yes
Dare	Online	Yorktown	-	-	-	-	Atlantic Ocean	-
	Online	Mid Yorktown	3,785	1.00	2,536	0.67	Pamlico Sound	Yes
	Online	Upper Yorktown	227	0.06	163	0.04	Pamlico Sound	Yes
	Online	Yorktown	7,571	2.00	1,090	0.29	Pamlico Sound	Yes
Hyde	Online	Castle Hayne	1,635	0.43	5,451	1.44	Pungo River (Pamlico Sound)	Pilot Study
	Online	Yorktown	1,090	0.29	310	0.08	Outfall ditch leading to Lake Mattamusket	Pilot Study
Camden	Online	Yorktown, Castle Hayne	2,271	0.60	757	0.20	Pasquotank River	Yes
Totals (current discharges to Sounds)			19,078	5	11,413	3		
Totals (proposed plants only)			37,854	10.00	12,643	3.34		

CHAPTER 2: WATER COLUMN CHEMISTRY OF AN RO-WTP PLUME AND AMBIENT
WATERS IN COASTAL NORTH CAROLINA

By

Katharine E. Kleber

Interdisciplinary Program in Biological Sciences

East Carolina University

Greenville, NC 27858

Abstract

Coastal North Carolina is addressing a constantly increasing human population and the associated increased demand for potable water with the development of Reverse Osmosis Water Treatment Plants (RO-WTPs). The main sources of water for these coastal RO-WTPs are two high-yielding briny aquifers. A byproduct of the RO-WTPs is a more concentrated solution discharged into ambient surface waters. Toxicity to resident biota through exposure to potentially unusual ratios of naturally occurring ions such as sodium, calcium, potassium, magnesium, chloride, and sulfate, within the briny concentrate is of concern in this study. One established RO-WTP, designated CML, was used as a model to investigate the concentrate plume and its effects on the ambient water chemistry. Twelve sample sites surrounding the effluent diffuser at the established plant were used to investigate the potential changes in water chemistry relative to the diffuser pipe. A control location was established 0.5 km downstream to investigate ambient conditions, and two sites of future discharge from RO-WTPs were also investigated. These two future RO-WTPs will each have an eight-fold increase of discharge over

that of the established plant investigated here. We collected water samples every two weeks from July 2005 to June 2006 at all locations. In-Plant samples indicated significantly higher ($p < 0.001$) levels of ammonium than were present at all sampling locations, and bottom (within 0.5 m of the substrate) samples taken at the diffuser did not differ significantly in ammonium from the 12 sampling sites around the diffuser. Most surface samples were indistinguishable in ammonium from the ambient waters of the Control location. Phosphorus levels were below detection at all sites, except bottom samples at the diffuser. Ambient salinity (including all ions tested) at the North River location was significantly higher ($p = 0.00$) than either the CML or the Control locations, but did not differ significantly from the Little River location. Water movement at all locations was correlated to both wind velocity taken from the EC-USCG station and the observed tide at Mann's Harbor marina. Average water velocity was lowest at the CML and highest at the Little and North rivers in the fall of 2005.

Introduction

During the 1990s, North Carolina's population increased by 21.7% and ranked ninth in the United States for population growth (United States Census Bureau 2007). Between 2000 and 2006, there have been additional population increases of 10.1% in the 20 coastal counties (United States Census Bureau 2007), most of which have limited access to fresh surface waters.

The surface waters of eastern North Carolina have attributes that make them unsuitable for processing into potable water, and many counties are too far inland to make importing ocean waters for desalination economically feasible (Hightower 2003; Younos 2005). Currently North Carolina has 12 Reverse Osmosis Water Treatment Plants (RO-WTPs) online to meet potable water demand (Figure 2-1). These plants withdraw water from local briny aquifers, and have a

combined production potential of 11.7 million gallons per day (MGD) (44,400 cubic meters per day [CMD]) of potable water while discharging 4.32 MGD (16,300 CMD) directly into the Albemarle and Pamlico sounds (Table 2-1). The briny discharges associated with these RO-WTPs will change the chemistry of the receiving waters; the magnitude of these changes will depend on the chemistry of the source waters as well as the chemistry of the receiving waters.

The aquifer system in the coastal plain of North Carolina is composed of several layers of eastward-thickening permeable sands or limestone separated by discontinuous clay-rich materials (confining units). The Surficial or unconfined aquifer overlies all the confined aquifers in the coastal plain (NCDENR 2010). The deeper aquifers are recharged through the Surficial aquifer near their westward limit; the water may flow eastward (down gradient) for tens of thousands of years before being withdrawn by water users in the coastal plain (Kennedy and Genereux 2007). Waters of the deeper Black Creek and Upper Cape Fear aquifers may be as old as 400-21,900 years (Kennedy and Genereux 2007).

The principal aquifers in North Carolina include the Lower Cape Fear, Upper Cape Fear, Black Creek, Peedee, Castle Hayne, Yorktown, and Surficial (Table 2-2). Throughout North Carolina, the Surficial Aquifer is a primary source of potable water for many communities and private wells (NCDENR 2010). It is the shallowest aquifer in the state and as such, flow varies directly with variations in precipitation, is at risk for saltwater intrusion and poor water quality from sources such as contamination from septic systems. The Surficial Aquifer is likely the primary source of recharge for all other aquifers within the state.

Because of the risks associated with use of the Surficial Aquifer, many communities and private homes are drilling deeper to reach the Yorktown and Castle Hayne aquifers. The Yorktown aquifer directly underlies the Surficial with the next deepest aquifer being the Castle

Hayne. Castle Hayne is the most productive and extensively developed aquifer within North Carolina (Lyke and Treece 1988; Sutton 1994; NCDENR 2010). These two aquifers are composed primarily of limestone (calcite and some dolomite) with some calcareous sands and minor amounts of clay throughout (Lyke and Treece 1988; Sutton 1994). Other minerals include calcium phosphate, glaucony, zeolite, microcrystalline quartz, pyrite, hematite and limonite (Otte 1981; Moran 1989).

Source waters for the established, and the two proposed RO-WTPs, are the Yorktown and Castle Hayne aquifers. Figure 2-2 compares the concentrations of major ions in waters from the Yorktown and Castle Hayne aquifers and the historic (1958-1973) average values for the Pasquotank River from the USGS sampling station near Elizabeth City. The Castle Hayne is predominantly a limestone aquifer and as such is significantly richer than the Pasquotank River in ions such as Ca^{2+} (73.0 versus 6.5 ppm), Cl^- (4,344.0 v. 63.0 ppm), and Mg^{2+} (82.0 v. 6.0 ppm) (Woods et al. 2000).

Currently no state or federal criteria exist for assessing the environmental impact of briny concentrate on benthic and pelagic biota or ambient water quality. Also, there have been few studies on the potential toxicity of the skewed inorganic ion ratios in the briny discharge when compared to those in the ambient waters. Goodfellow et al. (2000) suggested that osmotic stress and imbalance in an organism caused by unnatural ion ratios may have the potential for lethal toxicity. The main concern is that the inorganic ion imbalances may create problems with osmotic regulation of resident fish and invertebrates (Douglas et al. 1996; Goetsch and Palmer 1997; Goodfellow et al. 2000). Studying the potential toxicity of effluent *in situ* through field studies is often difficult. Instead, these studies are often conducted in a laboratory using mock effluent with model (usually tolerant) species, which allow for control of variables that cannot be

controlled in field studies (Alonso and Camargo 2003). The mathematical models that these laboratory studies produce become more complex with the addition of variables, such as differing salinities of the concentrate stream entering the receiving waters. These potential toxicities must also be tested *in situ* for verification.

Chlorine, ammonia, and heavy metals, as well as synthetic compounds, historically have been the major ions and substances of interest (Walker 1989; Bervoets et al. 1996; American Petroleum Institute 1998; Alonso and Camargo 2003). Using the proxy of Total Dissolved Solids (TDS) is an option, but not all ions are toxic in every environment. We must assess the actual ion concentrations to accurately determine the potential for toxicity.

The U.S. Environmental Protection Agency has adopted the Whole Effluent Testing (WET) model to assess effluent toxicity (Goodfellow et al. 2000). The primary objective of using the WET model is to try to ensure that the effluent does not pose a serious threat to aquatic life in the receiving waters. Toxicity may be the result of ion interactions, or of one or several of the ions present. The WET program models the major ions entering a system to predict the potential effects of the wastewater discharge.

The American Petroleum Institute (1998) has established relative ion toxicity for freshwater fish:

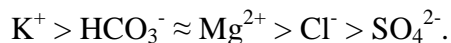

For the mysid shrimp, *Mysidopsis bahia*, the major ions influencing toxicity are:

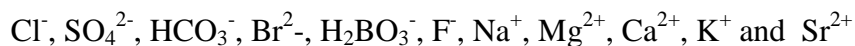

(in the order given by Goodfellow et al. 2000), but ion toxicity data for marine systems are rare.

Wastewaters with a ratio of Ca^{2+} to Na^+ of greater than 15:1 have been observed to cause

mortality in fathead minnows, *Pimephales promelas*, likely due to changes in the ability to osmoregulate (Goodfellow et al. 2000).

With the increasing demand for production of potable waters from RO-WTPs, potentially resulting in briny discharge into local waters, we investigated the potential effects of an established RO-WTP in Camden County (Camden Model Location, CML) and the changes to ambient water conditions. We were also interested in predicting the impact of two proposed plants in Pasquotank and Currituck counties, North Carolina (Figure 2-3). The CML plant discharges 0.200 MGD (757 CMD) into Chantilly Bay on the Pasquotank River just downstream from Elizabeth City, while producing 0.600 MGD (2,300 CMD) of potable water for the surrounding communities (Figure 2-4, A.), including the counties of Pasquotank and Currituck. Each proposed plant will discharge 1.67 MGD (6,300 CMD) directly into the Albemarle Sound at the mouth of the Little River (Pasquotank County, Figure 2-4, B.) and North River (Currituck County, Figure 2-4, C.) while producing 5.00 MGD (19,000 CMD) of potable water. These two plants combined will have the potential to produce and discharge almost the same volume as the other 12 plants, combined (Table 2-1). These two proposed plants will withdraw water from the same brackish aquifers as the CML (Yorktown and Castle Hayne) with increased potential production and discharges up to eight times greater than the CML.

We anticipate that there will be no detectable long-term effects on the water chemistry of the receiving waters. The objectives of this study were to investigate this assumption and establish the sphere of influence of the CML. This study also establishes pre-construction ambient water characteristics. In addition, we were able to investigate potential localized changes in water chemistry that may indicate the presence or persistence of the briny plume in the receiving waters. We believe that there should not be any localized effects of the briny

discharge on the local sediment, beyond the initial disturbance of the construction of the RO-WTPs. We make these statements knowing that the discharge rate will up to eight-fold greater at the proposed plants compared to the established CML. Using these data and assuming a similar composition of the source water at the new plants we may be able to predict the potential area of influence of the briny discharge. All these predictions assume that there will not be additional plants built nearby.

Study Locations

Albemarle Sound is part of the second largest estuary system in the United States (Albemarle-Pamlico Estuarine Study [APES]) (Giese et al. 1985; Hyland et al. 2004). The Sound is predominantly oligohaline (generally <5 ppt), and salinities are inversely related to river flow from eight major (Chowan, Roanoke, Pasquotank, Perquimins, Alligator, North, Little and Scuppernong) and several minor tributaries (Bowden and Hobbie 1977; Copeland et al. 1984; Giese et al. 1985). Albemarle Sound receives saltwater indirectly from the Atlantic Ocean through the Oregon Inlet and is affected by wind-dominated currents creating a generally well-mixed environment.

Waters just downstream of Elizabeth City and at the mouth of the Little River are classified by the State class SB, meaning that surface water uses include primary recreation, boating, fishing and frequent or organized swimming and all class SC uses (NCDENR 2010). Waters at the mouth of the North River are class SC, meaning that surface water uses include secondary recreation such as boating and fishing, where there is minimal skin contact (NCDENR 2010). The NC Division of Marine Fisheries under the Coastal Habitat Protection Plan considers the waters around Elizabeth City to be fish spawning habitat (NCDENR 2010).

Four locations in the Albemarle Sound were selected to assess the effects of briny concentrate discharged into ambient surface waters (Figure 2-3 and 2-4). The city of Camden, NC, RO-WTP, which has been operational since 2002, was used as a model of a currently operating RO-WTP (Camden Model Location, CML). With a center at the diffuser pipe, we established a grid with an “E-W” axis along the 2.1-m bottom contour, parallel to the shoreline and “N-S” axis perpendicular to the shoreline. In addition to the sample site at the diffuser, we established 12 additional sample sites along the axis at 0, 5, 15 and 25 m from the diffuser pipe (Figure 2-5). The location of our Control site was one-half km downstream of the CML in the same embayment of the river (Chantilly Bay) to create a site similar to the CML and represent ambient conditions (Figure 2-4, A.). Two other study locations were the areas of proposed RO-WTP discharge in counties adjoining Camden County: the mouth of the Little River (Pasquotank County) and the mouth of the North River (Currituck County).

Methods

Chemical Analysis

Water samples were collected every two weeks from all sites at all locations, and from inside the CML RO-WTP (in-plant) at the point just prior to discharge. Ambient surface and bottom water samples were collected using a horizontal Alpha-type water sampler within the 24-hour period after the first sample. All water samples were preserved in rinsed, acid-washed bottles and placed on ice until returned to the laboratory. On occasion, analytical duplicates were collected from the same site to allow for comparison over a brief (less than 5 minutes) period. Water samples also were taken from four locations along the “N-S” axis from the site closest to shore and moving out toward the main channel of the Pasquotank River (at 33, 78, 100,

and 220 m from 25m*S) to investigate the geographic extent of the plume into the surrounding environment.

All nutrient water samples were frozen immediately after arriving at the lab; all other water samples were refrigerated. Samples were analyzed for pH and alkalinity within two weeks of collection and then filtered (0.45 or 0.2 μm) and analyzed for nutrients by thawing samples in a refrigerator prior to analysis. Nitrate was reduced to nitrite with cadmium powder, and a solution of sulfanilamide with N-(1-naphthyl) ethylenediamine dihydrochloride added as the color agent (American Public Health Association 1992) was used to determine the total nitrate+nitrite (NO_3^- - NO_2^- -N) concentration. Analysis of samples was performed using a SmartChem Discrete Analyzer (Westco Scientific). Orthophosphate (PO_4^{3-} -P) was determined using an ascorbic acid method (American Public Health Association 1992) with a Scientific Instruments autoanalyzer to determine the concentration colorimetrically at 660 nm. Ammonia (NH_4^+ -N) concentrations were determined by the phenolhypochlorite method (Solorzano 1969); samples were measured colorimetrically at 640 nm. All data were reported in mg/L (ppm).

Anion (chloride and sulfate) concentrations were measured by comparing filtered samples to the standards of 1, 10, 20, and 30 ppm of Cl^- and SO_4^- using Shimadzu Ion Chromatography/Liquid Chromatography. For cations (calcium, magnesium, potassium, and sodium), filtered samples were compared to the standards of 3/30, 5/50, 10/100, 30/300 and 50/500; the first number of each standard indicates the concentration (ppm) of Ca^{2+} , Mg^{2+} and K^+ , and the second number is the concentration of Na^+ . Concentrations were measured with a Perkin-Elmer Inductively Coupled Argon Plasma – Optical Emission Spectrometer (ICP-OEC – model Optima 2100DV). Cation data collected from the ICP-OEC were processed using WinLab32 for ICP. Any sample with a concentration outside the range of the standards was

diluted and re-analyzed. The standards used mimicked the proportions and encompassed the ranges expected in the ambient environment. Analytical duplicates always yielded results within 10% of one another and usually within 3%.

The salinity data were compared using a Student's t-test across locations to determine if the locations differed significantly. To assess possible toxicity of the briny concentrate at the CML we calculated the ratio of calcium (Ca^{2+}) to sodium (Na^+) ions (Goodfellow et al. 2000). The complete array of ion data were used to model mineral saturation for each location using PHREEQCI (U.S. Geological Survey 2010). PHREEQCI is a graphical user interface for PHREEQC (Version 2), a low-temperature aqueous geochemical program based on ion-association (Parkhurst and Appelo 1999). This software was used to forecast mineral precipitation from the briny discharge entering the surface waters at our study locations in the Albemarle Sound.

Water Quality Data

We obtained vertical water profiles concurrent with water samples collected from each of the 18 sampling sites. Profiles were obtained using a YSI model 85 water quality meter. Data were collected at 0.5 m below the surface and at 0.5-m increments until just above the bottom. Parameters measured were dissolved oxygen (mg/L and % saturation), temperature ($^{\circ}\text{C}$), temperature-corrected conductivity ($\mu\text{S}/\text{cm}$), and salinity (ppt). At the time of sampling, surface pH, wind speed (KPH), wind direction, secchi disk visibility (m), and prevailing weather conditions also were recorded.

Near the diffuser pipe at the CML, two Hydrolab DS5X Extended Deployment water quality sondes were deployed between July 2005 and January 2006. These sondes were mounted

horizontally on stainless steel frames 0.5 m above the substrate, in 1.2 m of water between N1 and N2 (shallow); and 2.2 m of water, between S1 and S2 (deep). The Hydrolabs recorded water temperature, dissolved oxygen, conductivity (μS), salinity, pH, total dissolved solids (g/L), and chlorophyll *a* ($\mu\text{g/L}$) every 30 minutes. Data were downloaded monthly; units were then cleaned of periphyton and inhabitants and redeployed. During April and May 2006, one Hydrolab sonde was relocated to each the North River and Little River to observe the time-series changes of these two locations.

Water Movement

At the CML, Little River, and North River locations a RD Instruments Workhorse Rio Grande 1200 kHz ADCP (acoustic Doppler current profiler) was used to determine net water movement and long-term trends in water current direction and speed under prevailing weather conditions. Each unit was programmed to record velocity (mm/sec) and direction at 0.10 m intervals (“bins”) from about 0.31 m above the bottom (height of the unit head, plus clearing distance) to the surface (“ensembles”). Each bin contained many pieces of information, but this study used water velocity and direction (compass heading) by date and time. Two ADCPs were deployed at the CML along-side the Hydrolab data sondes at 1.2 m and 2.2 m. In addition, two more ADCPs were deployed at either the Little River or North River locations and were alternated between the two locations monthly. We deployed the units at the depths of 1.2 m and 2.1 m at each location to bracket the proposed depth of discharge.

ADCP data were downloaded monthly and viewed using WINADCP software (RD Instruments, Inc.). All ensembles were examined for the period of record and bins near the surface and above were deleted from the data set because of unstable readings caused by wave

action. BBLIST software (RD Instruments, Inc.) was used to convert the original binary code to ASCII format with the variables: ENSEMBLE, DATE, TIME, MAGNITUDE, and DIRECTION. These data were then imported into Excel (Microsoft). Because direction was recorded in tenths of a degree (from 0.0 to 359.9°), the direction of water movement was summarized to the eight major points of the compass in the following manner:

N	= 337.6° – 359.9°, and 0.0° – 22.5°
NE	= 22.6° – 67.5°
E	= 67.6° – 112.5°
SE	= 112.6° – 157.5°
S	= 157.6° – 202.5°
SW	= 202.6° – 247.5°
W	= 247.6° – 292.5°
NW	= 292.6° – 337.5°.

Prevailing water flow direction was summarized by counting the number of records in which each of the eight major compass headings was recorded. SAS 9.1 (SAS Institute, Inc.) was used to combine Excel spreadsheets for the largest files, and then transpose the datasets into a format that could be analyzed. For ADCPs deployed at the 2.1 m contour, data were separated by depth into surface (bins 12-16), midwater (bins 6-11) and bottom (bins 1-5). For ADCPs deployed at 1.2 m, the data were separated into surface (bins 6-11) and bottom (bins 1-5). For each depth-section, water velocity and corresponding dominant compass direction for each bin was averaged over the course of a one-hour period to produce net distance of water movement (m/hr) with the associated direction vector. These hourly data then were merged with hourly weather data from the Elizabeth City USCG station. PROC FREQ was used to determine the net movement of water per hour for each compass heading, and PROC CORR was used to determine the relationship between weather variable and the net distance of water movement for each compass bearing. Correlation coefficients (r) between net distance of water movement (m/hr) and weather variable were considered significant at $\alpha = 0.05$.

Sediments

Monthly sediment samples were collected by sediment core from July-December 2005 from all sites at all locations to investigate possible variations in sediments over time. A diver procured samples by inserting a 7.6-cm diameter by 30.5-cm sediment core tube to at least 10 cm, then bringing the sample to the surface where it was capped, labeled with date and site, and stored for processing. Substrate analysis examined only the top 5 cm of sediment. We extruded the top 5 cm and dried the sample overnight. The dry sample was then homogenized and split to yield 25-50 grams of sample. It was treated with 30% hydrogen peroxide to remove organic matter and wet-sieved with Calgon dispersant into a settling cylinder through a 4Φ ($62.5\mu\text{m}$) screen to separate the silt/clay fraction from the coarse material. Five ml of dispersing agent was added to the settling cylinder along with enough distilled water to bring the volume to the 1-L mark. Two beakers were cleaned, dried, weighed and labeled with the size fraction. The solution in the settling cylinder was agitated in preparation for pipette analysis. Immediately following agitation, a 20-ml aliquot of solution was pipetted from 20 cm below the solution surface and expelled into a labeled beaker for drying and weighing. This aliquot represented the sediment smaller than 4Φ ($62.5\mu\text{m}$). Forty-seven minutes and 14 seconds later, another 20-ml aliquot was pipetted from 5 cm. This later aliquot represented the sediment smaller than 8Φ . The sediment fractions between 4Φ and 8Φ , and less than 8Φ , were calculated from this procedure. The coarse fraction remaining on the 4Φ screen was rinsed into a beaker, dried overnight and weighed.

Loss on ignition (LOI) was used to determine the organic matter content. First, a dry sample was placed into a pre-weighed crucible and the initial weight was recorded. Next, the

sample was put into an oven at 500° C for four hours to burn off organic matter. Samples were then placed in a dessicator to cool and final weight of each sample was recorded to calculate organic content.

Results

Chemical Analysis

The CML RO-WTP (In-Plant) is introducing significant (two-tailed Student's t-test; $p < 0.001$) amounts of ammonium (NH_4^+) to bottom waters when compared to all other locations (Table 2-3). These high levels were evident at the diffuser and the 5m*S (5 m from the diffuser in the south direction) locations, with concentrations sometimes greater than 10 times higher than those observed from the other CML sites (Figure 2-6). The averaged CML samples taken reflected values similar to those from the Control location (generally < 0.065 ppm; $p = 0.064$). The Little River and North River locations had significantly lower ammonium concentrations (~ 0.02 ppm) than those observed from the CML ($p = 0.038$ and 0.041 respectively; Table 2-3) and the Control locations (p -values = 0.009 and 0.021 respectively; Table 2-3). Temporal variation in ammonium was similar across all samples, with a sharp increase in August 2005 for the diffuser site and in September 2005 for the other CML sites, declining over the winter months with a significant increase beginning in late spring 2006. Phosphorus (PO_4) was below detection at all locations, with the exception of the In-Plant samples.

Concentrations of major conservative anions (Cl^- and SO_4^-) closely followed/mirrored temporal and geographic patterns exhibited by the major cations (Mg^{2+} , Na^+ , Ca^{2+} and K^+). The main source of chloride and sulfate in these estuarine waters is seawater. As predicted by the proportions of major conservative ions in seawater, chloride and sodium were present in

concentrations about 10 times greater than the other major conservative ions (Figure 2-7). Concentrations of major ions were consistently higher from the In-Plant samples.

Salinities showed a trend of higher values in the fall and winter with a decrease into the spring (Figure 2-8). Salinity samples taken In-Plant, just prior to discharge, indicated high significantly higher salinities when compared to the *in situ* water samples, with salinities ranging from 10.2 ppt to 15.2 ppt (one outlier of 4.9 ppt in July 2005), and a range from the average bottom (within 0.5 m from the substrate) salinity of the CML sites between 0.7 ppt and 6.1 ppt (Table 2-4). Salinity measurements taken with the YSI model 85 meter were not significantly different from the analyzed samples (two-tailed Student's t-test, $\alpha = 0.05$; $p = 0.703$). Even with this addition of briny concentrate, surface salinities generally remained below 1.0 ppt except for late fall when the salinities increased to around 5.0 ppt (Figure 2-9). Salinities for the Little River and North River locations mirrored those taken at the CML; averaging 1.0 ppt in the summer, and became more saline (5.9 and 7.1 respectively) into winter (Figure 2-8).

The water column at the CML exhibited stratification, with the ion concentrations generally higher at the bottom and decreasing in the surface samples. Surface samples were more similar to the Control location than the bottom samples, though the differences between surface and bottom water samples were not significant ($p > 0.1$ for all samples). Water samples taken May 2006 along the N-S axis and into the Pasquotank River indicated that the concentrations of the major conservative ions was similar to the concentrations from the surface samples at the CML at distances beyond 30 m from the 25m*S (Figure 2-10). Calcium to sodium ratios at the CML never reached 15:1, the level of observed toxicity. Ratios of the two ions at all locations averaged 1:20 and never less than 1:13 (Table 2-5).

Calculation of the mineral saturation indices (PHREEQCI) indicated that there is the potential for precipitation of calcite/aragonite (CaCO_3) and dolomite ($\text{CaMg}(\text{CO}_3)_2$) at the diffuser and the surrounding 5 m bottom sites in all directions. With the higher salinities of the receiving waters and the higher proposed discharge rates at the Little River and North River locations, there is a chance that the waters at these two locations will achieve saturation at greater distances from their diffusers than that observed for the CML.

Water Quality Data

In general, salinities were higher at the Little River and North River locations throughout the year when compared to the CML and Control locations. Mean salinities and conductivities were found to be statistically similar for the CML and Control locations ($p = 0.749$, Table 2-4). Salinity and conductivity were found to be statistically similar between the CML and the Little River location ($p = 0.18$, Table 2-4) and significantly higher at the North River than the CML ($p = 0.024$, Table 2-4), while the North River location was not significantly different from the Little River location ($p = 0.192$, Table 2-4). Mean monthly temperatures were not significantly different from location to location. In general, the water columns at the Control, Little River, and North River locations were well mixed. Samples from the CML indicated that the water column at this location was generally well-mixed over the study period. A comparison of the salinities taken across the year of study indicated that there were no statistically significant differences between the surface and bottom waters at any location.

The *in situ* data set provided by the Hydrolab data for the shallow (between 5m*N and 15m*N) and deep (between 5m*S and 15m*S) locations (0.5 m above the substrate) at CML indicates that water temperatures ranged from a high of 35 °C in August 2005 and decreased

through November 2005 to 23 °C (Figure 2-11, A.). Conductivities showed an opposite trend from the temperature data with lower values in August 2005, generally increasing from October 2005 (Figure 2-11, B.). We observed a spike in conductivity in August 2005 from the deep Hydrolab sonde not apparent at the shallow site suggesting that the briny plume was moving southward from the diffuser at that time. Daily fluctuations of conductivity were observed from the October 2005 data from the shallow Hydrolab sonde.

In the months of April and May 2006, we deployed one Hydrolab sonde at each of the Little River and North River locations. Spring temperatures from these two locations were consistently lower than those observed from August to December 2005 at CML (Figure 2-12, A.) following expected seasonal trends. Conductivities at the two future discharge locations were consistently higher than the CML/Control locations (Figure 2-12, B.).

On a daily basis, average dissolved oxygen values generally remained above the 4.0 mg/L minimum recommended by the U.S. EPA for fish health in fresh waters. There were observations of minimum dissolved oxygen below this threshold in August and October 2005 from both the shallow and deep hydrolabs (Figure 2-13). The average dissolved oxygen reading was generally above the EPA threshold. In November 2005, there were several times when the minimum dissolved oxygen fell below the EPA threshold and all readings were below the 4.0 mg/L threshold on November 21, 2005 at the shallow site (Figure 2-13, A). Average dissolved oxygen from the Little River and North River locations never fell below the U.S. EPA minimum recommended for fish health (Little River: Figure 2-14).

Water Movement

The Little River and North River locations are higher energy environments based on the water velocity and direction data recorded by the ADCPs deployed at the 1.2-m (shallow) and the 2.1-m (deep) contours.

Little River. In November, waters at the Little River 2.1-m contour averaged over 200 m/hr at the bottom and midwater divisions and movement was dominantly to the NW or SE. Surface waters averaged more than 700 m/hr with no dominant direction of the waters (Table 2-6). Correlation analysis revealed that some environmental variables recorded at the Elizabeth City USCG (USCG-EC) weather station were significantly correlated with net water movement at the deep contour from certain compass bearings, but none of these correlations were strong enough to be meaningful. Significant relationships were considered to be those greater than ± 0.750 . For example, surface water movements to the SW at the deep contour from November 11 through December 2, 2005 (Table 2-6), averaged 752.4 m/hr and were inversely related ($p = -0.224$) to wind velocity 10 m above the ground at the USCG-EC weather station. Average water movements within the bottom bins were above 200 m/hr and to all compass headings. Data from the shallow ADCP indicated that the surface water movements were nearly 1 km/hr or more to all compass headings. Correlations of the variable air temperature with the Little River shallow ADCP suggested that air temperature might be correlated with another environmental variable such as wind direction or wind velocity (perhaps a weather change), but air temperature was not significantly correlated with water movements at the deep Little River location.

In late February and March 2006 water movement information for the Little River location was available only for the shallow contour (Table 2-7). Net water movement at the

bottom was more than 300 m/hr and NE and SE directions dominated at that time. A strong positive correlation between wind velocity and eastward movement (but few observations, n = 20) suggested that the water movement eastward may have been related to a strong weather event. Surface water movements at the 1.2 m contour were stronger, more than 600 m/hr to nearly 1 km/hr, with dominant movements to the SE, NE, and SW. Wind velocity was positively and significantly related to the net distance of water movement at all recorded compass bearings (Table 2-7).

Late May and June 2006 water movement information for the Little River location was available only for the deep contour (Table 2-6); net distance of late spring water movements was substantially higher than that observed in November with surface velocities > 1 km/hr. Net water movement in the bottom division was above 300 m/hr, with slight preference for the SW quadrant. In the midwater division, movements were primarily NW and SE: weakest movements were NW (421 m/hr) and strongest movements were SE (1.7 km/hr) (Table 2-6).

North River. Water movement at the North River location appear to be related to wind direction and velocity and to the observed tides and water temperature at Mann's Harbor Marina. Water flow was greatest in the fall, smallest during the winter, and moderated during late spring and early summer. In general water flows were stronger at the shallow contour compared to the deep contour during the same period. September results from the deep ADCP indicate that water movements averaged above 500 m/hr at all bins (Table 2-8). Strongest average currents were in the midwater where water movement averaged over 1 km/hr to all compass points. Surface water movements were similar to the midwater, to all compass points with no dominant direction. Correlation analysis revealed that some September environmental variables recorded at the EC-USCG were significantly correlated with net water movement to certain compass

bearings at the 2.1 m contour. Wind velocity from the USCG-EC weather station 10 m above the ground was positively correlated with surface water movement to the SE direction, and inversely related to midwater movements to the NE and SW directions (Table 2-8). In bottom waters, water flow to the SE was inversely related to air temperature and wind velocity and direction. Waters moving in the NE direction were inversely related to the predicted tide at Mann's Harbor, and positively correlated with the Mann's Harbor water temperature (Table 2-8). Shallow water movements during the same period were much stronger, averaging over 1.0 km/hr (Table 2-8). Wind direction and wind velocity were significantly correlated with most compass bearings of water movement, and the observed tide at Mann's Harbor was correlated with water movement direction and distance especially for the surface portion of the water column (Table 2-8).

October average water movements at both the deep and shallow sites at the North River location were less strong than those observed in September, ranging from 135 to 554 m/hr at the deep site to 155 to 970 from the shallow site (Tables 2-8, 2-9). At the deeper site, NE water movements dominated the midwater and surface divisions of the water column (Table 2-8). The strongest correlation ($r = 0.345$) was water flow in the NW direction with air temperature recorded at the EC-USCG station. Shallow water movements were all correlated with wind velocity at the EC-USCG station, and most water movement directions were correlated with wind direction as well (Table 2-9). The water temperature at Mann's Harbor was significantly related to water movement and direction especially in the surface division of the water column, and the observed Mann's Harbor tide was correlated with northerly water movements (Table 2-9).

The January water movement data indicated the weakest movements for both sites at the North River location. The NE compass bearing was dominant, and surface flows were only slightly stronger than bottom flows. At the 2.1 m contour, water movements were significantly related to wind direction and wind velocity, and observed tides at Mann's Harbor marina (Table 2-8). The same correlations were observed for water movements at the 1.2 m contour (Table 2-9). Weather was relatively quiet during the January 2006 period; this may have accounted for the results observed by the ADCP units at that time.

Water movement during April at the North River deep site was stronger than those observed in January ranging from average movements of 153 to 857 m/hr (Table 2-8). As seen in previous months, water flows and direction were correlated with wind velocity and wind direction, especially flows in the NW and SW directions. Water movements also were correlated with Mann's Harbor water temperatures, and movement to the NW was negatively correlated with predicted tide at Mann's Harbor marina (Table 2-8).

CML. Net water movement at the CML was much lower than that observed from either the Little River or the North River locations, and reflected protection from influence of the open Sound and Pasquotank River main channel flow. In October 2005, net distance of water movement at the 2.1 m contour ranged between 125 and 305 m/hr at all depths with SE and NW flows most prevalent for all bins (Table 2-10). Surface water movement was significantly and positively correlated with the tides at Mann's Harbor marina, but midwater and bottom water movements did not exhibit this strong trend observed at the surface. Wind velocity was positively correlated to net movement of surface water. From late December 2005 through mid-January 2006 net water movement at the 2.1 m contour was lower than 79 m/hr at all depths and direction of flow was to all compass points. In May, net water flow movement ranged from 88

to 424 m/hr at all depths; net movement was to the SE in the bottom and midwater divisions and to the NW in the surface division (Table 2-10). Net distance for some compass points was positively related to wind direction and wind velocity recorded at the USCG-EC station.

At the shallow contour in September 2005 water movements at the surface were greater than those observed at the deep contour; net movement was primarily to the SW and SE and was positively correlated with wind velocity and air temperature from the USCG-EC weather station (Table 2-11). Water movement at the bottom was dominantly in the SE direction and was positively correlated with air temperature from the USCG-EC weather station. Greatest distance of water movement occurred at the surface in late September through October ranging from 0.7 to 1.1 km/hr. Values decreased in October, November and December with dominant movement in the SE direction, except in November-December bottom bins when movement was to all compass directions. April values were < 59 m/hr at all depths, and water movement was to all compass points. In May and June, net water movement increased and was oriented primarily to the SE and NW; air temperature and wind velocity were positively correlated to net water movement distance (Table 2-11).

Sediments

The sediments at the CML showed high levels of organics (high LOI) present at the diffuser, 5*E and 5*S sites (Table 2-12). During our study there was a displacement of one (of eight) diffuser check valves from the diffuser pipe. Before we replaced the check valve, a hole approximately 1 m³ was excavated by the discharge stream. It is possible that the subsequent natural re-filling of this hole has resulting in an increase in organic matter found at these three sites. Excluding these three sites (July-December 2005), sand was the dominant sediment

fraction surrounding the CML. Sediments at the Control location were sand with a slightly higher percentage of silt and clay. Both the Little River and North River sediments were sand.

Discussion

We were interested in potential water quality changes caused by an established RO-WTP discharging into a coastal watershed, and the possible risk to resident and transient biota in the area. This study provided a baseline of information at an established RO-WTP and at two locations prior to the construction of the proposed RO-WTP in Pasquotank and Currituck counties, North Carolina.

Ratios of all conservative ions from the In-Plant samples were similar to those of the ambient receiving waters at the CML. There is still concern about potential ion-imbalances to resident and transient biota from the quantity of higher salinity waters from the RO-WTP discharge (Douglas et al. 1996; American Petroleum Institute 1998; Goodfellow et al. 2000; NCDENR 2007). We may expect that with the relatively well-mixed water-flow characteristics of these shallow locations any minerals that precipitate out will quickly dissolve when exposed to the shifting, under-saturated ambient water mass. These expectations are calculated with a discharge rate of 0.2 MGD; the area of influence will likely increase with a higher discharge. Mixing of the briny discharge waters with ambient waters may minimize problems for mobile organisms but perhaps pose problems for sessile organisms that cannot avoid the plume. In addition, because the source aquifers tend to be rich in calcium (Figure 2-2) the ratio of calcium to sodium could be a potential source of toxicity, as observed by Goodfellow et al. (2000) with fathead minnows. At no time, however, did the ratio of calcium to sodium ever even approach the ratio of 15:1 from any location sampled. Also of concern is the high concentration of

ammonium (NH_4^+ -N) and nitrite + nitrate (NO_x^- -N) entering the Little River and the North River locations, areas of relatively low concentrations of nitrogen (Camargo and Ward 1992; Alonso and Camargo 2003). Nitrogen is usually the limiting nutrient in saline waters (McConnaughey and Zottoli 1983) and as such, enrichment in these locations may lead to increased eutrophication and possibly increased photosynthetic activity, including the possibility of algal blooms. There was no such activity observed at the CML during the study, which may be related to the ubiquitous presence of tannins and lignins in the river waters reducing light penetration and therefore limiting photosynthetic activity (Bricaud et al. 1981; Hernes and Hedges 2004; Gallegos 2005; Dobberfuhl 2007). The elevated nutrient concentrations were limited to the bottom waters within 5 m of the diffuser pipe. The risk of eutrophication may be more significant in the waters at the Little River and North River locations, where fewer tannins and lignins are present and higher rates of discharge (up to 1.67 MGD) and a correspondingly larger plume are projected. However, these future discharge locations are higher energy regimes so it is likely that any additional nutrients will rapidly mix into the ambient waters.

All locations showed no significant variation between concurrent surface and bottom samples. Analysis of the In-Plant discharge sample showed consistently higher levels of the major anions and cations as well as ammonia (NH_4^+ -N). This signature was periodically observed near the diffuser pipe, usually in the south direction, but it was diluted from the In-Plant values and not evident beyond 5 m. The YSI handheld meter and the Hydrolab sonde were unable to detect the plume directly; however, these meters allowed for both “snapshot” and stationary site observations of oxygen within the systems as well as supporting the water chemistry data that was observed. The stationary sites gave a context for interpretation of the data from both the YSI “snapshots” and the surface and bottom water samples.

Because of the dynamic nature of the plume, the two Hydrolab data sondes placed approximately 7 m from the diffuser were not able to detect the plume consistently, but did allow for temporal visualization of ambient water chemistry. The YSI meter allowed for a “snap shot” visualization of the chemistry around the diffuser, with conductivity providing the best traceable illustration, though high variability in single readings indicated a fairly well-mixed combination of discharge and ambient waters.

Sediments were consistent with earlier investigations of this area (Giese et al. 1979; Eaton 1994 and 2001; Hyland et al. 2004), consisting mainly of sands with some organic matter. The sediments did not vary over the six months of sediment sampling. Overall water chemistry varied seasonally with higher salinities during the fall and winter months and decreasing salinities throughout spring. As observed with most coastal waters, sodium and chloride concentrations were about 10 times higher than their associated major constituents at all locations over the course of the study.

The general water flow pattern for all locations indicates that water movements were faster at or near the surface and were oriented following river flow, mainly correlated with wind velocity recorded 10 m above ground at the Elizabeth City USCG station and/or with observed tides recorded at Mann’s Harbor marina. This observed flow pattern may change with significant weather events, but we were not able to detect a storm such as Hurricane Ophelia (Category I, September 15, 2005, passing off-shore of North Carolina) using our available equipment. Overall water velocities were slower at CML than at either the Little River or North River discharge sites indicating that both locations are higher energy systems with potentially higher turnover rates relative to discharge rates from the two new RO-WTPs.

Conclusions

The Little River and North River RO-WTPs each have the potential to discharge up to eight-times more than the current discharge of the Camden Model Location. We documented the chemical signature and sphere of influence of the plume at the established Camden RO-WTP to attempt to predict what effect the two new plants may have on the receiving waters. Based on the information presented here we provide the following conclusions:

- The Little River and North River locations are similar to each other in terms of water quality and water chemistry.
- The CML and the Control locations are similar to each other in water quality and water chemistry.
- Salinities were significantly lower at the CML/Control locations compared to the North River location, but were statistically similar to the Little River location.
- Salinity differences are likely due to proximity to the Atlantic Ocean, not to the existing Camden RO-WTP.
- During the one-year study period ambient waters had lower salinities during summer, with increasing salinity during the winter months and decreasing again through the spring.
- Dissolved oxygen concentrations were consistently good for organism health as defined by the U.S. EPA standards.
- The water columns at all locations were well-mixed, and any minerals precipitating from the RO-WTP discharge are likely to quickly re-dissolve as unsaturated water masses move through.

- RO-WTP discharge was more easily detected in bottom samples at the diffuser and sites within 5 m (100 m²) around the diffuser; surface water parameters approximated ambient waters.
- With this apparent dilution within 5 m, the area of influence of the briny plume would be at least 640 m².
- Levels of calcium to sodium at the CML did not approach the toxicity range of 15:1 reported in the published literature on test organisms.
- Sediments at all locations were classified as primarily sand with little organic matter present, similar to earlier studies of these areas.

Acknowledgements

Special thanks go to Dr. R. Rulifson, Dr. T. Woods, Co-PIs; and committee members Dr. A. Overton and Dr. E. Reyes. I want to extend my many thanks to the students in the Rulifson Lab and the Woods Lab for numerous hours in the field and eager and helpful lab assistance and to Dr. R. Corbett for the use of his laboratory. Thank you to the counties of Pasquotank and Currituck, North Carolina for funding. And thank you to the Institute for Coastal Science and Policy at East Carolina University for the provision of lab space and office support.

References

- Alonso, A., and J.A. Camargo. 2003. Short-term toxicity of ammonia, nitrite, and nitrate to the aquatic snail *Potamopyrgus antipodarum* (Hydrobiidae, Mollusca). *Bulletin of Environmental Contamination and Toxicology* 70: 1006-1012.
- American Petroleum Institute 1998. The toxicity of common ions to freshwater and marine organisms. Document 0300-029. Washington, DC.
- American Public Health Association. 1998. Standard methods for the examination of water and wastewater, 18th ed.: Washington D.C.
- Bricaud, A., A. Morel, and L. Prieur. 1981. Absorption by dissolved organic matter of the sea (yellow substance) in the UV and visible domains. *Limnology and Oceanography* 26: 43-53.
- Bowden, W.B., and J.E. Hobbie. 1977. Nutrients in Albemarle Sound, North Carolina. University of North Carolina, Sea Grant, publication 75-25, Raleigh.
- Bervoets, L., M. Baillieul, R. Blust, and R. Verheyen. 1996. Evaluation of effluent toxicity and ambient toxicity in a polluted lowland river. *Environmental Pollution* 91: 333-341.
- Camargo, J.A., and J.V. Ward. 1992. Short-term toxicity of sodium nitrate (NaNO₃) to non-target freshwater invertebrates. *Chemosphere* 24: 23-28.
- Copeland, B.J., R.G. Hodson, S.R. Riggs, and E.C. Pendleton. 1984. The ecology of the Pamlico River, North Carolina: an estuarine profile. U.S. Fish and Wildlife Service Report FWS/OBS-82-06.
- Dobberfuhl, D.R. 2007. Light limiting thresholds for submerged aquatic vegetation in a blackwater river. *Aquatic Botany* 86: 346-352.
- Douglas, W.S., S.S. Grasso, D.G. Hutton, and K.R. Schroeder. 1996. Ionic imbalance as a source of toxicity in an estuarine effluent. *Archives of Environmental Contamination and Toxicology* 31: 426-432.
- Eaton, L. 1994. A preliminary survey of benthic macroinvertebrates of Currituck Sound, North Carolina. *The Journal of the Elisha Mitchell Scientific Society* 110: 121-129.
- Eaton, L. 2001. Development and validation of biocriteria using benthic macroinvertebrates for North Carolina estuarine waters. *Marine Pollution Bulletin* 42: 23-30.

- Gallegos, C.L. 2005. Optical water quality of a blackwater river estuary: the Lower St. Johns River, Florida, USA. *Estuarine, Coastal and Shelf Science* 63: 57-72.
- Giese, G.L., H.B. Wilder, and G.G. Parker Jr. 1979. Hydrology of major estuaries and sounds of North Carolina. U.S. Geological Survey. *Water Resources Investigations* 79-46. 175 p.
- Goetsch, P.-A., and C.G. Palmer. 1997. Salinity tolerances of selected macroinvertebrates of the Sabie River, Kruger National Park, South Africa. *Archives of Environmental Contamination and Toxicology* 32: 32-41.
- Goodfellow, W.L., L.W. Ausley, D.T. Burton, D.L. Denton, P.B. Dorn, D.R. Grothe, M.A. Heber, T.J. Norberg-King, and J.H. Rodgers, Jr. 2000. Major ion toxicity in effluents: a review with permitting recommendations. *Environmental Toxicity and Chemistry* 19: 175-182.
- Hernes, P.J. and J.I. Hedges. 2004. Tannin signatures of barks, needles, leaves, cones, and wood at the molecular level. *Geochimica et Cosmochimica Acta* 68: 1293-1307.
- Hightower, M. 2003. Desalination of inland brackish water: issues and concerns. *Southwest Hydrology*. May/June 2003: 18-19.
- Hyland, J.L., W.L. Balthis, M. Posey, C.T. Hackney, and T. Alphin. 2004. The soft-bottom macrobenthos of North Carolina estuaries. *Estuaries* 27: 501-514.
- Kennedy, C.D., and D.P. Genereux. 2007. ^{14}C groundwater age and the importance of chemical fluxes across aquifer boundaries in confined cretaceous aquifers of North Carolina, USA. *Radiocarbon* 49: 1181-1203.
- Lyke, W.L., and M.W. Treece, Jr. 1988. Hydrogeology and effects of ground-water withdrawals in the Castle Hayne aquifer in coastal North Carolina. In Lyke, W.L., and T.G. Hoban, eds. *Proceedings of the symposium on coastal water resources*. Wilmington, NC, p. 469-478.
- McConnaughey, B.H., and R. Zottoli. 1983. *Introduction to marine biology*, 4th ed. Waveland Press. Prospect Heights, IL. 638pp.
- Moran, L.K. 1989. Petrography of unconformable surfaces and associated stratigraphic units of the Eocene Castle Hayne Formation, southeastern North Carolina Coastal Plain. M.S. thesis, East Carolina University, Greenville, NC, 337pp.
- NCDENR 2007. NPDES permitting strategies for potable water treatment plants, September 2007. North Carolina Department of Environment and Natural Resources.
http://h2o.enr.state.nc.us/NPDES/documents/WTPpermittingstrategy07_000.pdf. Accessed July 17, 2010.

- NCDENR. 2010. North Carolina Aquifers. North Carolina Department of Environment and Natural Resources. Division of Water Quality.
http://www.newater.org/Education_and_Technical_Assistance/Ground_Water/AquiferCharacteristics/. Accessed July 17, 2010.
- Otte, L.J. 1981. Petrology of the exposed Eocene Castle Hayne limestone of North Carolina. Ph.D. thesis, University of North Carolina, Chapel Hill, NC, 183pp.
- Parkhurst, D.L., and C.A.J. Appelo. 1999. User's guide to PHREEQC (Version 2) – A computer program for speciation, batch-reaction, one-dimensional transport, and inverse geochemical calculations: U.S. Geological Survey Water-Resources investigations Report 99-4259, 310 p.
- Solorzano, L. 1969. Determination of ammonia in natural waters by the phenol hypochlorite method. *Limnology and Oceanography* 14: 799-801.
- Sutton, L.C. 1994. Groundwater geochemistry of the Castle Hayne aquifer in capacity use area No. 1. North Eastern NC. M.S. thesis, East Carolina University, NC, 148pp.
- U.S. Census. 2007. State and County Quick Facts. North Carolina QuickLinks
<http://census.gov/qfd/states/370001k.html>. Accessed July 17, 2010.
- U.S. Geological Survey. 2010. PHREEQC (Version 2)--A Computer Program for Speciation, Batch-Reaction, One-Dimensional Transport, and Inverse Geochemical Calculations. http://wwwbrr.cr.usgs.gov/projects/GWC_coupled/phreeqc/. Accessed July 17, 2010.
- Walker, J.D. 1989. Effects of chemical on microorganisms. *Water Pollution Control Federation* 61: 1077-1097.
- Woods, T.L., E. G. Beck, D.L. Tolen-Mehlhop, R. Troiano, and J.K. Whitley. 2000. Geochemical tracers of groundwater movement between the Castle Hayne and Associated Coastal Plain aquifers. University of North Carolina Water Resources Research Institute Report Number 328, 237 p.
- Younos, T. 2005. The Economics of Desalination. *Journal of Contemporary Water Research & Education* 132: 39-45.

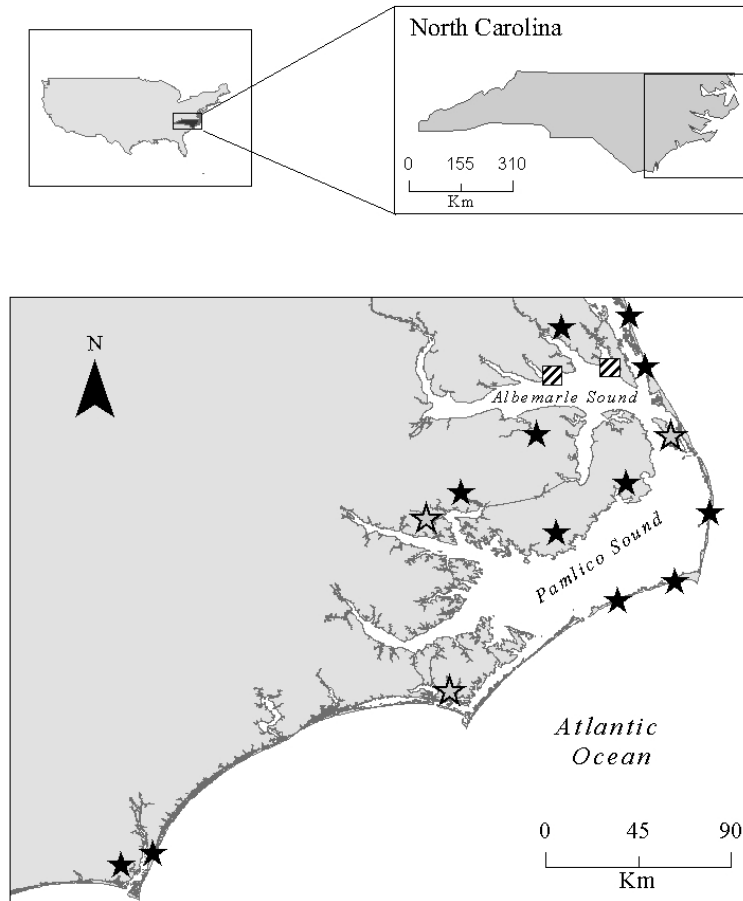

Figure 2-1. Map of the 15 currently operating Water Treatment Plants (WTPs) in the coastal counties of North Carolina with the 12 black stars representing the Reverse Osmosis-WTPs and the three gray stars representing other water treatment methods. The two striped squares represent the two proposed RO-WTPs.

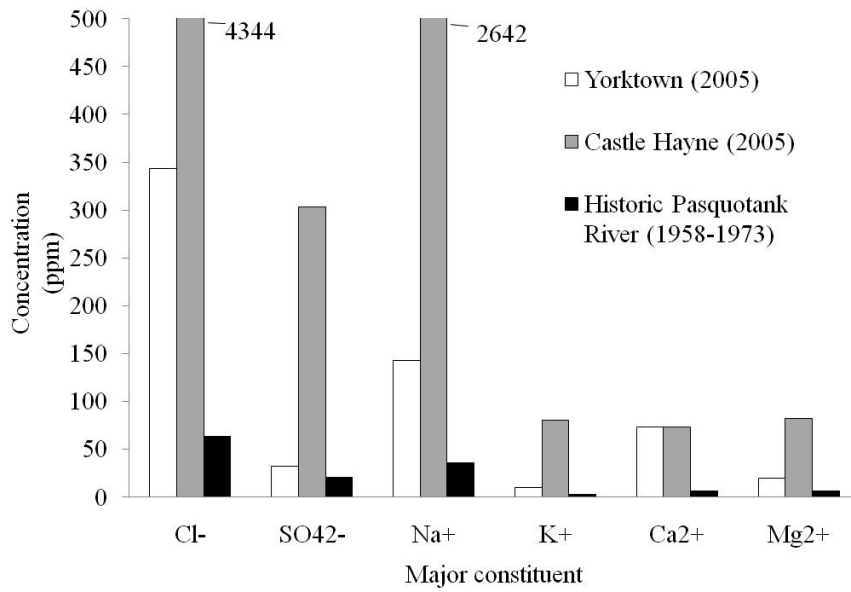

Figure 2-2. Average concentrations (ppm = mg/L) of major ions in water samples collected from the Yorktown and Castle Hayne aquifers at the pump houses in 2005, compared to Pasquotank River samples collected by the USGS between 1958 and 1973.

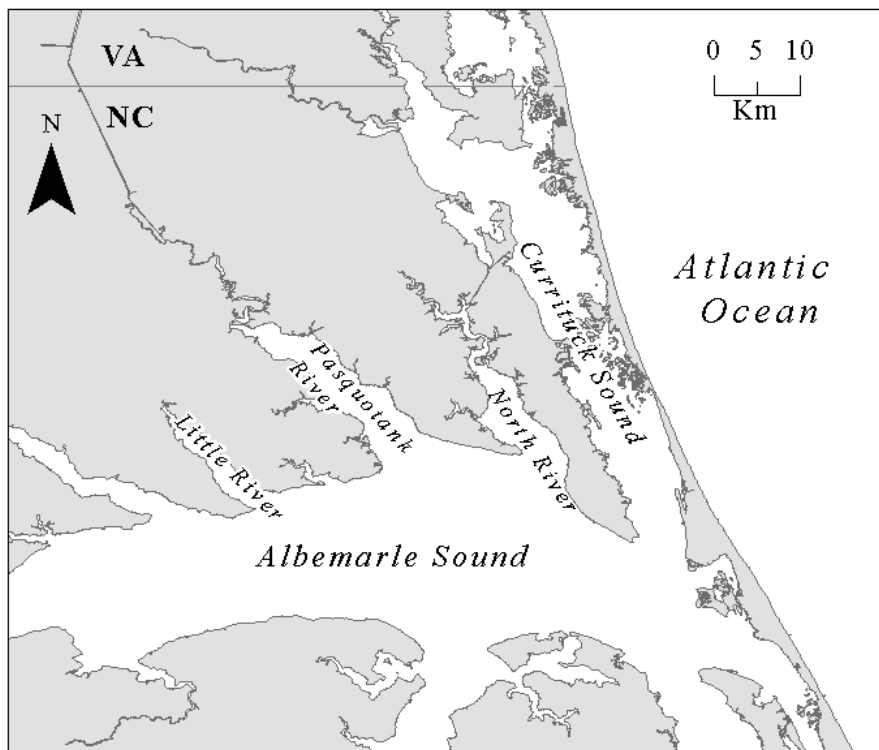
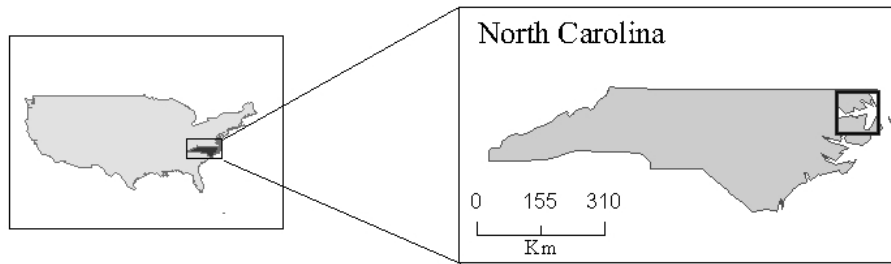

Figure 2-3. Map of study locations; Pasquotank River is the location of the Camden Model Location (CML) and Control location. The mouths of the Little River and North River are the other two sampling locations.

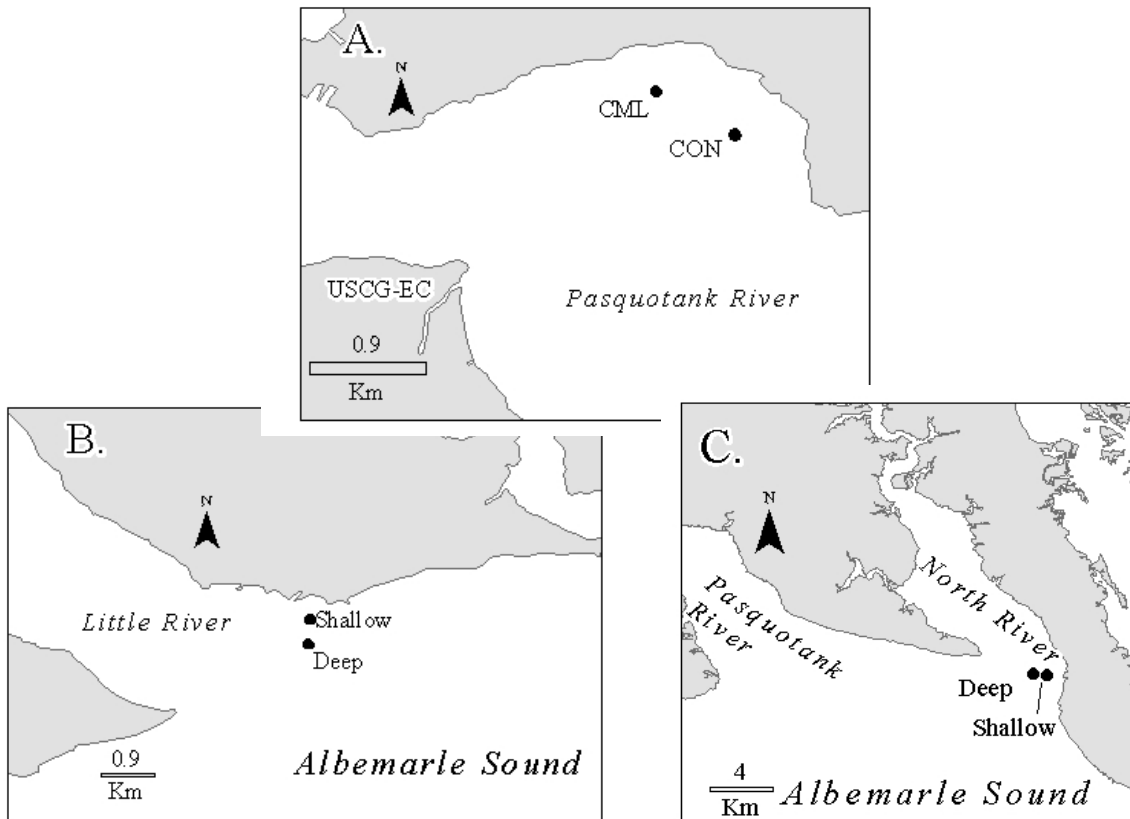

Figure 2-4. Details of study locations, Camden Model Location (CML) and Control locations on the Pasquotank River (A), across from the U.S. Coast Guard station at Elizabeth City(USCG-EC), and the Little River (B) and North River (C) locations, including the shallow (S) and deep (D) sites. Figure 2-5 describes the arrangement of the sampling grid at the CML.

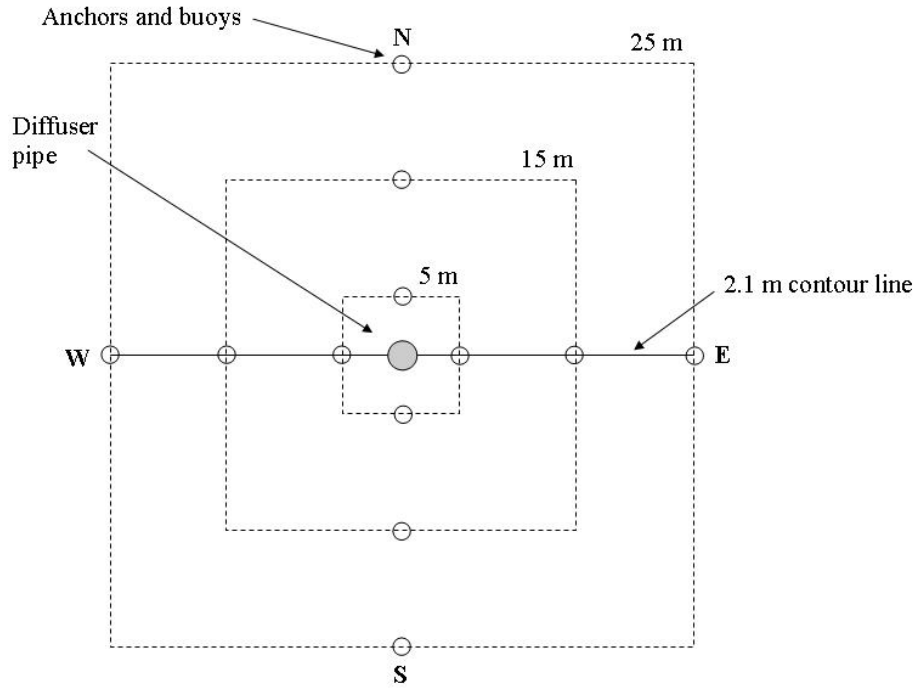

Figure 2-5. Arrangement of sampling grid at Camden Model Location (CML). N-S set perpendicular to shore and E-W axis approximated the 2.1-m contour, with the diffuser pipe as the center site. 25m*N site was 1.3 m deep and the 25m*S site was 2.7 m deep. Stream flow was generally from “W” to “E.” Total area was 2,500 m².

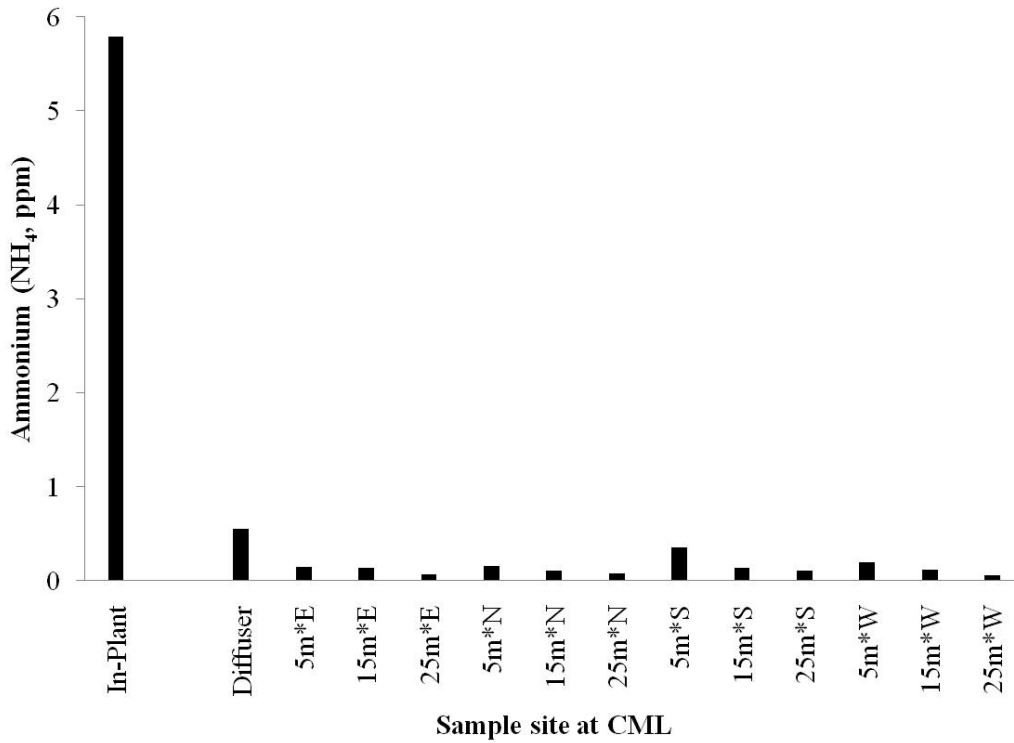

Figure 2-6. Average ammonium concentration (NH₄⁺-N, ppm = mg/L) from the In-Plant sample (far left) compared to all bottom (within 0.5 m of the substrate) 13 sites at the Camden Model Location (CML) July 2005 – June 2006.

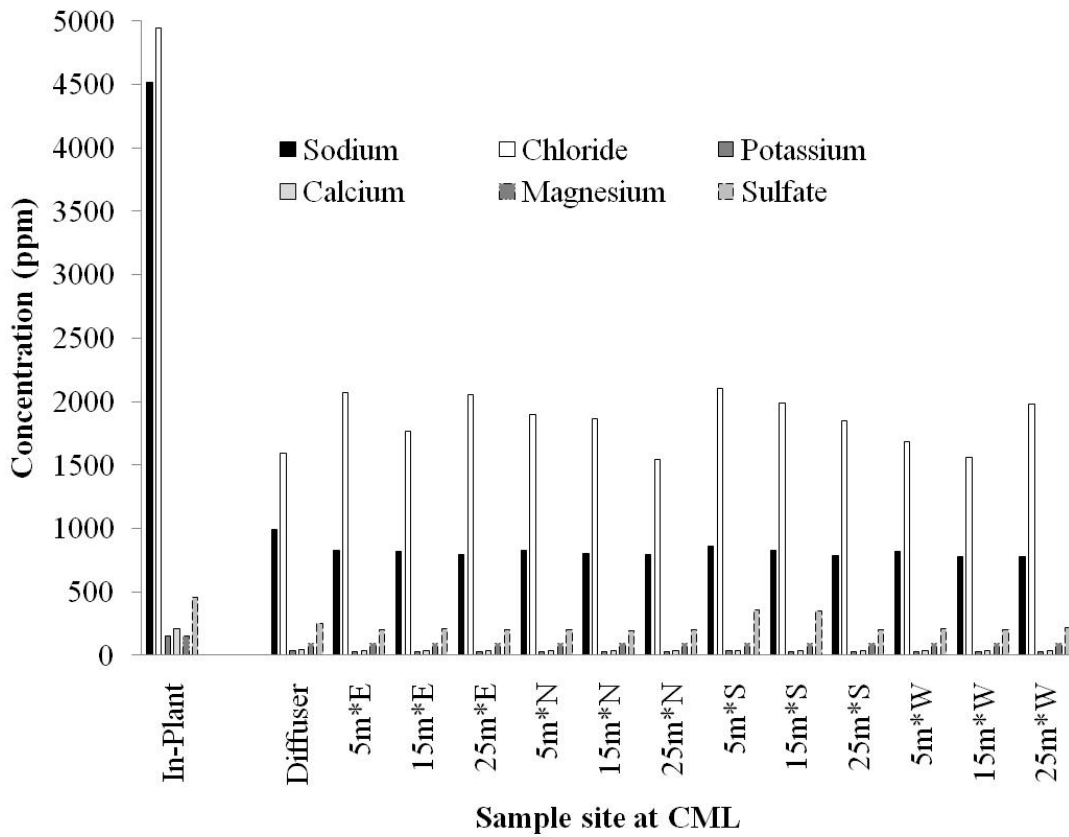

Figure 2-7. Comparison the overall average data for the concentrations of sodium (Na^+), chloride (Cl^-), Potassium (K^+), calcium (Ca^{2+}), Magnesium (Mg^{2+}), and sulfate (SO_4^{2-}) ions from the In-Plant samples compared to the 13 sites at the Camden Model Location.

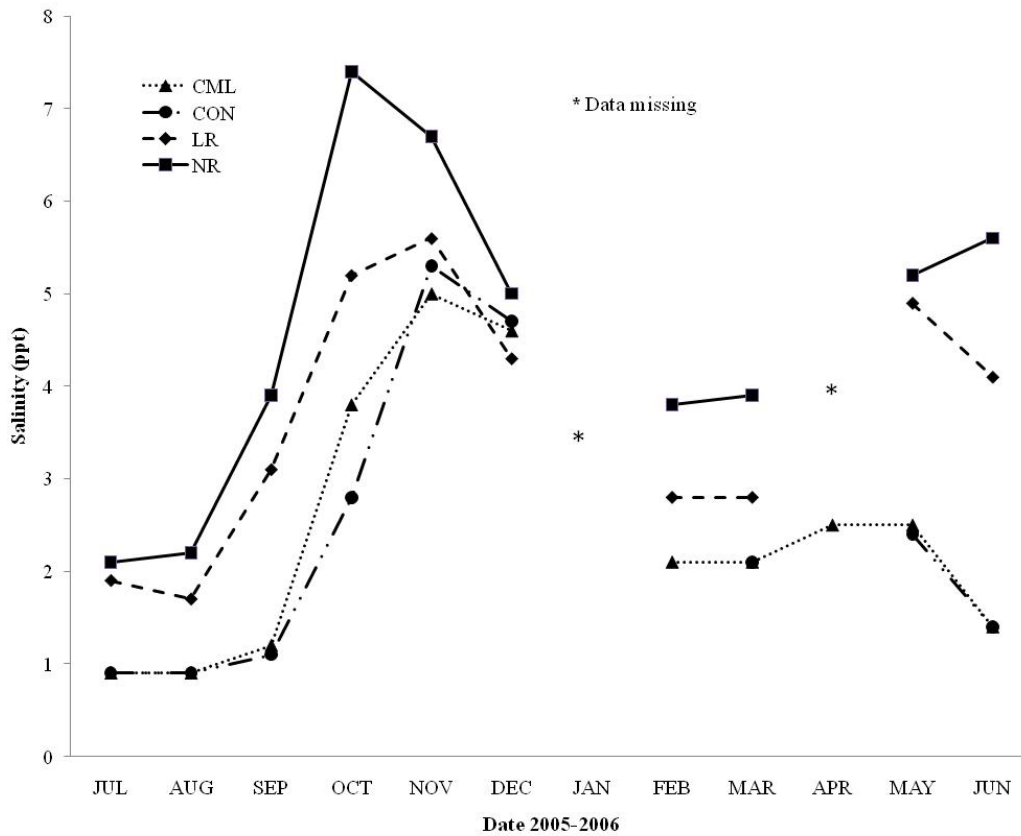

Figure 2-8. Average salinity (ppt) measured by YSI model 85 at the four different study locations from July 2005-June 2006. CML=Camden Model Location, CON=Control, LR=Little River, and NR=North River. Asterisks indicate missing data.

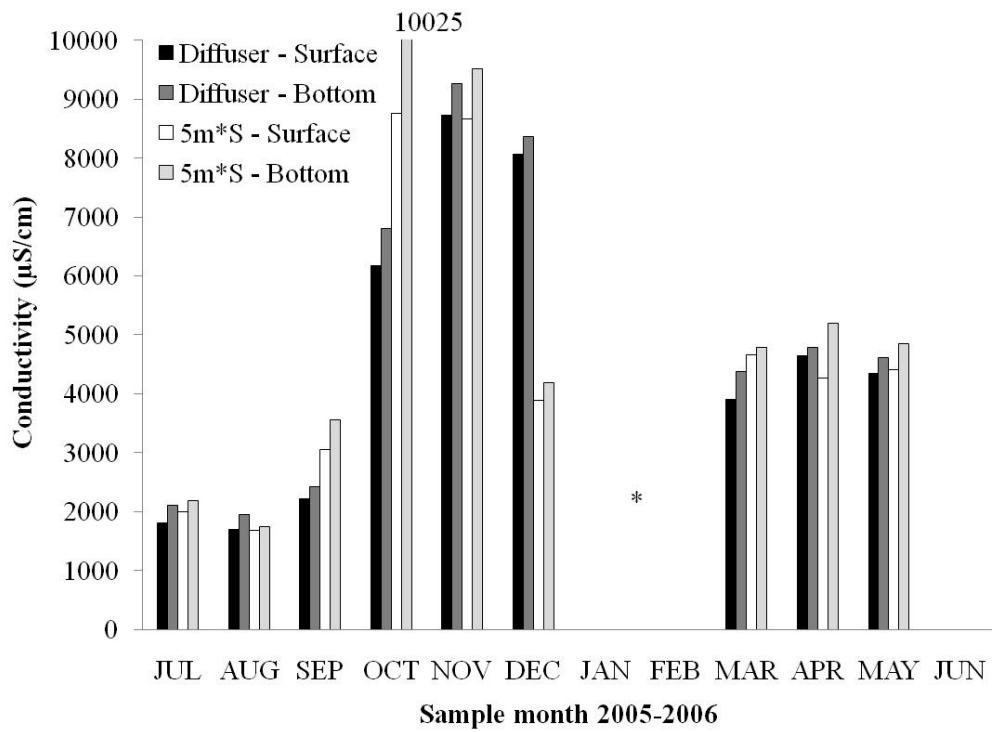

Figure 2-9. Comparison of surface and bottom conductivities ($\mu\text{S}/\text{cm}$) at the diffuser and the 5m*S site at the Camden Model Location (CML) showing that the water column is usually well-mixed. Asterisk indicates missing data.

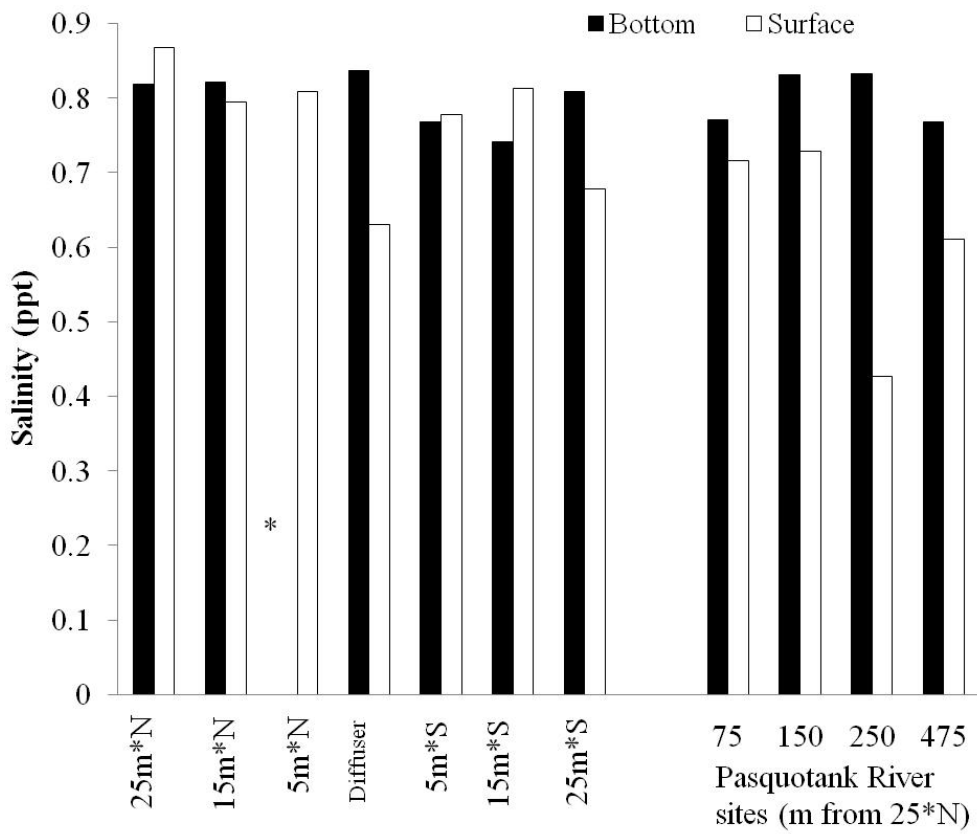

Figure 2-10. Salinity (chemical analysis) along the N-S axis of the Camden Model Location (CML) and out into the Pasquotank River; 75, 150, 250, and 475 m from the 25m*N site May 2006. Asterisk indicates missing data.

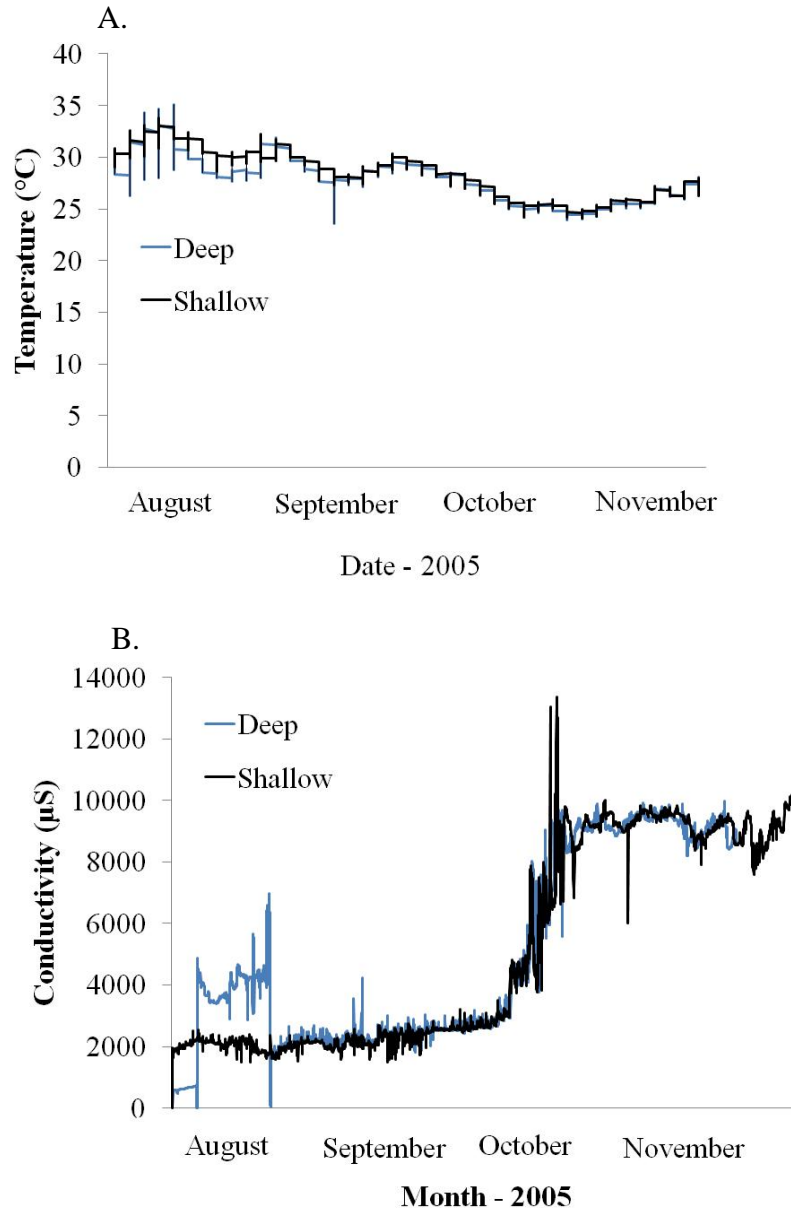

Figure 2-11. Hydrolab data sonde daily temperature (A) and conductivity (B) data from CML, shallow (1.2 m) and deep (2.2 m), bracketing the diffuser, from August 11 through November 21, 2005. Sonde were deployed approximately 0.5 m above the substrate.

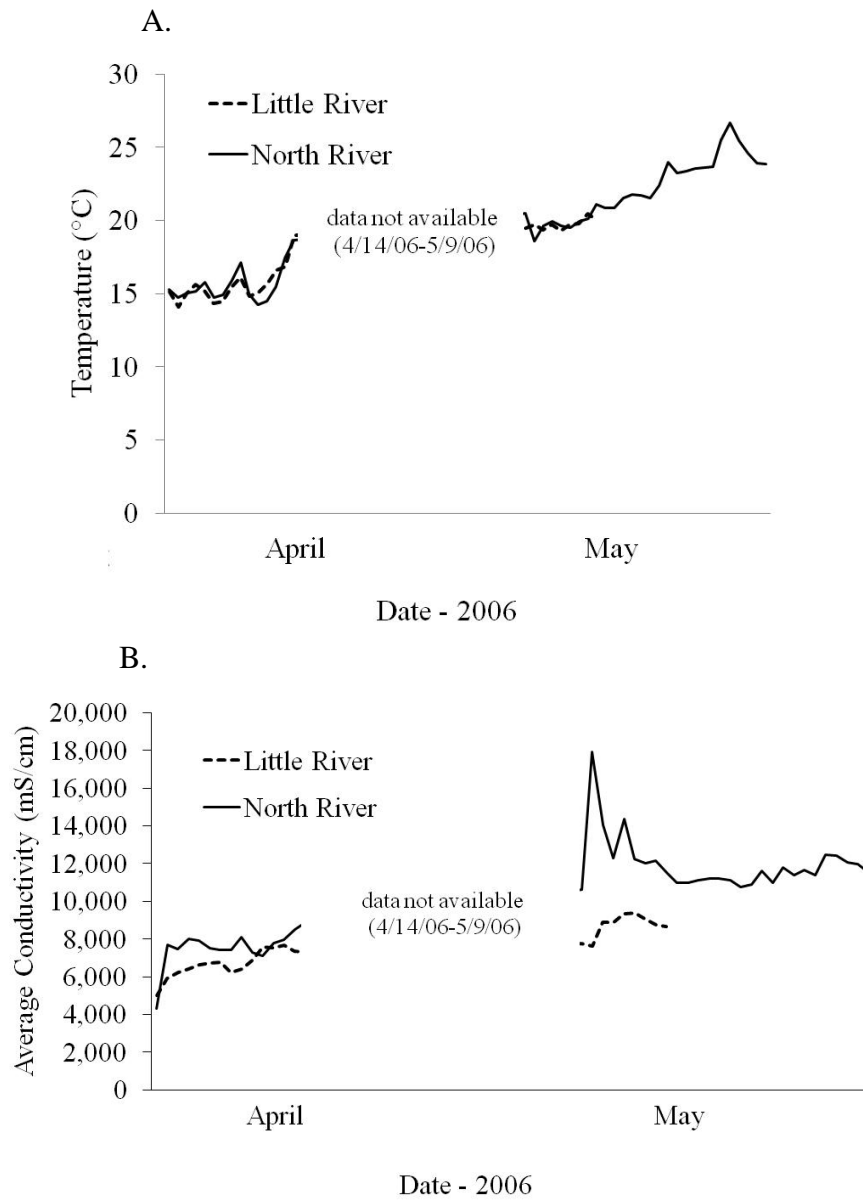

Figure 2-12. Hydrolab data sonde daily temperature (A) and conductivity (B) data from the Little River and North River locations, March 31-June 5, 2006. Sondes were deployed approximately 0.5 m above the substrate.

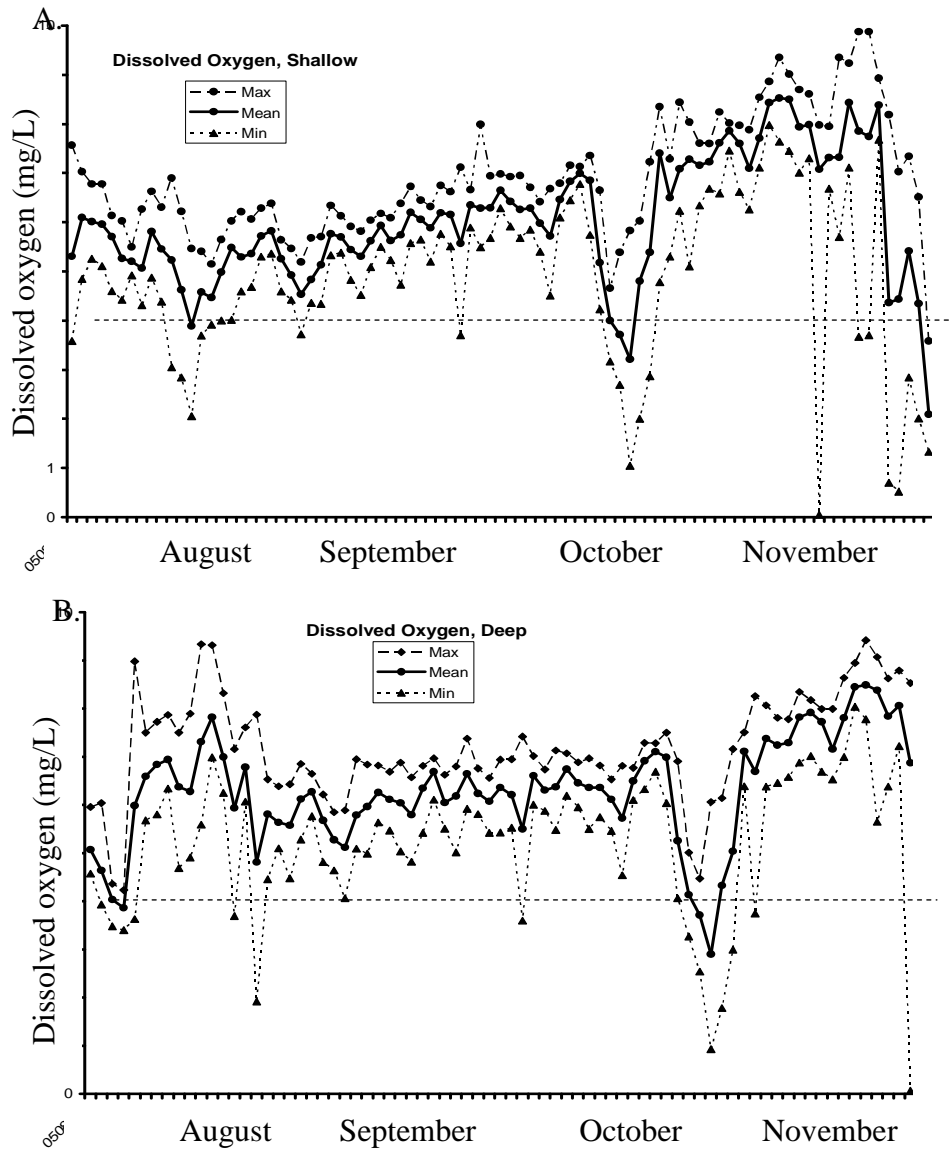

Figure 2-13. Daily mean, maximum and minimum dissolved oxygen (mg/L) values recorded by the Hydrolab data sonde, 0.5 m from the bottom at the 1.2 m contour (A) and at the 2.2 m contour (B) at distances of 7 m from the Camden RO-WTP discharge pipe, August 11 – November 21, 2005. Dashed line at 4.0 mg/L is the U.S. EPA minimum for fish health. Sonde were deployed approximately 0.5 m above the substrate.

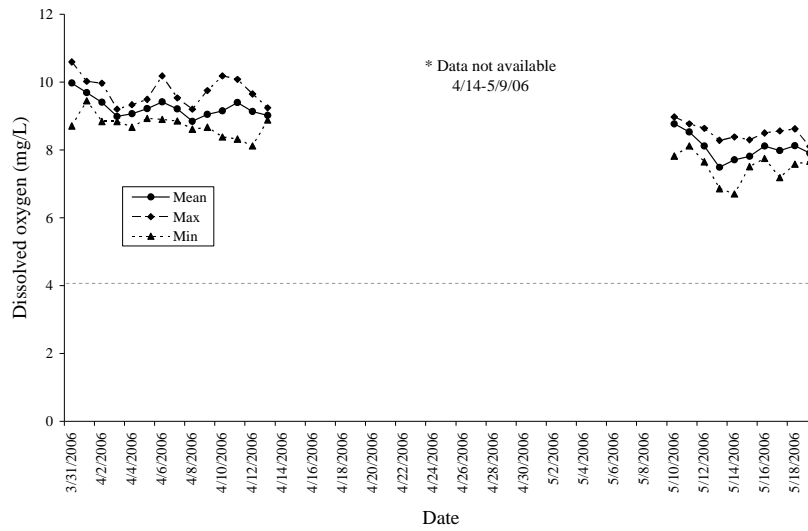

Figure 2-14. Daily mean, maximum and minimum dissolved oxygen (DO) (mg/L) values recorded by the Hydrolab data sonde deployed at the 2.2 m contour of the Little River location April 31 – May 18, 2006. Dashed line indicates U.S. EPA recommended minimum DO for fish health. Sondes were deployed approximately 0.5 m above the substrate.

Table 2-1. Twelve current and two proposed Reverse Osmosis Water Treatment Plants (RO-WTPs) in the state of North Carolina including the County in which the plant is located, operation phase, source aquifer, production and discharge rates (cubic meters per day (CMD) and millions of gallons per day (MGD)), receiving body of water, and if a preconstruction study was completed. "#=" Proposed RO-WTPs; “-“ = data not available.

County	Operation phase	Aquifer(s)	Production		Discharge		Discharge water body	Pre-construction study?
			CMD	MGD	CMD	MGD		
Brunswick	Online	Castle Hayne	583	0.15	227	0.06	Infiltration lagoons (non-discharge)	Yes
New Hanover	-	-	-	-	-	-	-	-
Ocracoke	Online	Castle Hayne	1,961	0.52	1,037	0.27	Pamlico Sound	Yes
# Pasquotank	Proposed	Castle Hayne	18,927	5.00	6,322	1.67	Albemarle Sound	Yes
Tyrrell	Online	Castle Hayne	1,628	0.43	379	0.10	Albemarle Sound	Plume Study
# Currituck	Proposed	Yorktown	18,927	5.00	6,322	1.67	Albemarle Sound	Yes
	Online	Yorktown	3,785	1.00	1,181	0.32	Atlantic Ocean	Yes
Dare	Online	Yorktown	-	-	-	-	Atlantic Ocean	-
	Online	Mid Yorktown	3,785	1.00	2,536	0.67	Pamlico Sound	Yes
	Online	Upper Yorktown	227	0.06	163	0.04	Pamlico Sound	Yes
	Online	Yorktown	7,571	2.00	1,090	0.29	Pamlico Sound	Yes
Hyde	Online	Castle Hayne	1,635	0.43	5,451	1.44	Pungo River (Pamlico Sound) Outfall ditch	Pilot Study
	Online	Yorktown	1,090	0.29	310	0.08	leading to Lake Mattamusket	Pilot Study
Camden	Online	Yorktown, Castle Hayne	2,271	0.60	757	0.20	Pasquotank River	Yes
Totals (current discharges to Sounds)			19,078	5	11,413	3		
Totals (proposed plants only)			37,854	10.00	12,643	3.34		

Table 2-2. Relationship of geologic and hydrographic units in the North Carolina central coastal plain (NCCCP). Modified from NC Division of Water Resources Ground Water Management Section 2005. Modified from www.crrw.utexas.edu.

North Carolina Central Coastal Plain Geologic Units			North Carolina Central Coastal Plain Hydrologic Units
System	Series	Formation	Aquifers and Confining Units
Quaternary	Holocene	Undifferentiated	Surficial Aquifer
	Pleistocene		Yorktown Confining Unit
Tertiary	Pliocene	Yorktown	Yorktown Aquifer
			Castle Hayne Confining Unit
	Middle Eocene	Castle Hayne Formation	Castle Hayne Aquifer
			Beaufort Confining Unit
	Upper Paleocene	Beaufort Formation	Beaufort Aquifer
			Peedee Confining Unit
Cretaceous		Peedee Formation	Peedee Aquifer
			Black Creek Confining Unit
		Black Creek Formation	Black Creek Aquifer
			Upper Cape Fear Confining Unit
		Cape Fear Formation	Upper Cape Fear Aquifer
			Lower Cape Fear Confining Unit
Lower Cape Fear Aquifer			

Table 2-3. Two-tailed Student's t-test, $\alpha = 0.05$, comparing ammonia concentrations from the In-Plant samples compared to the average of the 13 water samples taken within 0.5 m of the bottom at the Camden Model Location (CML), Control (CON), Little River (LR), and the North River locations, July 2005 – June 2006. Asterisk indicates statistical significance.

Sites	In-Plant	CON	LR	NR
CML	* <0.001	0.064	*0.038	*0.041
CON	* <0.001		*0.009	*0.021
LR	* <0.001			0.419
NR	* <0.001			

Table 2-4. Two-tailed Student's t-test, $\alpha = 0.05$, comparing salinity (chemical analysis) from the In-Plant samples to the average of the 13 water samples collected within 0.5 m of the bottom at the Camden Model Location (CML), Control (CON), Little River (LR), and the North River locations, July 2005 – June 2006. Asterisk indicates statistical significance.

Sites	In Plant	CON	LR	NR
CML	*<0.001	0.938	0.069	*0.007
CON	*<0.001		0.093	*0.012
LR	*<0.001			0.198
NR	*<0.001			

Table 2-5. Ratios (maximum, minimum and average) of calcium (Ca^{2+}) to sodium (Na^+) ions from all study locations: Camden Model Location (CML), Control (CON), Little River (LR), and North River (NR), between July 2005 and June 2006.

Location	Maximum	Minimum	Average
CML	1:37	1:13	1:20
CON	1:27	1:14	1:20
LR	1:35	1:17	1:24
NR	1:34	1:21	1:25

Table 2-6. Significant ($p \leq 0.05$) Pearson correlation coefficients of the net distance of water movement (m/hr) by net movement direction and vertical position (surface, midwater, and bottom) recorded by the Little River Deep (2.1 m) ADCP profiler, weather recorded at the Elizabeth City Coast Guard Station (EC), and the tide data at Mann's Harbor (MH) marina for dates indicated. N = number of water movement observations in the direction indicated. Bottom = bins 1-5 (0.31-0.71 m); Midwater = bins 6-11 (0.81-1.31 m); Surface = bins 12-16 (1.41-1.81 m).

Dates and Direction	N	Average movement (m/hr)	Air temp EC	Wind vel. EC	Wind dir. EC	Precip. EC	Tide pred. MH	Tide Obs. MH	Water temp MH
11/11 - 12/02/05									
Surface									
NE	109	820.0	-0.277				-0.273		-0.420
SE	89	855.7					-0.217		
SW	96	752.4		-0.224		-0.510		-0.282	
NW	91	788.4	-0.226				-0.215	-0.308	-0.282
Midwater									
NE	60	219.0							
SE	124	386.5		0.205	0.237		-0.261	0.199	-0.273
SW	52	214.6							-0.314
W	1	623.7							
NW	148	311.4							
Bottom									
NE	79	209.4		0.228			-0.236		
E	7	469.4							
SE	101	344.4		0.337		-0.785	-0.238	0.286	-0.264
SW	68	271.3							-0.422
W	1	593.7							
NW	129	290.3							
5/23 - 6/22/06									
Surface									
NE	157	1,084.0							
SE	148	1,131.0							
SW	179	1,197.0							
NW	156	1,263.0							

Table 2-6, continued

Dates and Direction	N	Average movement (m/hr)	Air temp EC	Wind vel. EC	Wind dir. EC	Precip. EC	Tide pred. MH	Tide Obs. MH	Water temp MH
Midwater									
N	5	1,048.0							
NE	93	1,504.0							
E	9	1,092.0							
SE	148	1,765.0							
S	16	1,008.0							
SW	99	1,405.0							
W	4	628.2	0.999						
NW	266	421.3							
Bottom									
NE	156	330.4			0.346				
SE	149	332.5							
SW	195	321.1		0.312					
NW	140	277.7	0.367	0.419					

Table 2-7. Significant ($p \leq 0.05$) Pearson correlation coefficients of the net distance of water movement (m/hr) by net movement direction and vertical position (surface and bottom) recorded by the Little River Shallow (1.2 m) ADCP profiler, weather recorded at the Elizabeth City Coast Guard Station (EC), and the tide data at Mann's Harbor (MH) marina for dates indicated. N = number of water movement observations in the direction indicated. Bottom = bins 1-5 (0.31-0.71 m); Surface = bins 6-11 (0.81-1.41 m).

Dates and Direction	N	Average movement (m/hr)	Air tempEC	Wind vel.EC	Wind dir. EC	Precip. EC	Tide pred. MH	Tide Obs. MH	Water temp MH
11/11 - 12/12/05									
Surface									
NE	122	970.0	-0.480						-0.545
E	2	954.4							
SE	137	1,212.0	-0.280		0.190				-0.352
SW	123	1,042.0				0.653			-0.228
NW	142	928.0	-0.471				-0.173	-0.194	-0.514
Bottom									
NE	108	317.3					0.233	0.264	-0.266
E	3	557.6							
SE	134	509.1	-0.310	0.172	0.224	0.646	-0.200		-0.367
SW	125	643.0	-0.496		0.274			0.287	-0.487
W	2	341.8							
NW	154	371.3		0.403				0.170	-0.200
2/24 - 3/31/06									
Surface									
NE	226	947.7	0.168	0.357					
SE	279	808.0	0.310	0.420	0.212		-0.181		0.287
SW	212	668.7	0.208	0.356	-0.227			-0.174	0.163
NW	120	762.8		0.253				-0.191	
Bottom									
NE	254	317.6	0.341	0.296	0.224				0.277
E	20	411.4		0.781					
SE	261	442.1		0.315	0.317				
SW	127	387.8							
W	6	366.9							
NW	169	336.4							

Table 2-8. Significant ($p \leq 0.05$) Pearson correlation coefficients of the net distance of water movement (m/hr) by net movement direction and vertical position (surface, midwater, and bottom) recorded by the North River Deep (2.1 m) ADCP profiler, weather recorded at the Elizabeth City Coast Guard Station (EC), and the tide data at Mann's Harbor (MH) marina for dates indicated. N = number of water movement observations in the direction indicated. Bottom = bins 1-5 (0.31-0.71 m); Midwater = bins 6-11 (0.81-1.31 m); Surface = bins 12-16 (1.41-1.81 m).

Dates and Direction	N	Average movement (m/hr)	Air temp EC	Wind vel. EC	Wind dir. EC	Precip. EC	Tide pred. MH	Tide Obs. MH	Water temp MH
September 2005									
Surface									
NE	35	774.1							
SE	57	627.5		0.317					
SW	63	824.0							
NW	46	790.4							
Midwater									
NE	29	1,030.0		-0.440					
SE	28	761.7							
SW	78	1,065.0		-0.286					
NW	66	1,022.0							0.353
Bottom									
NE	41	959.1					-0.318		0.456
SE	42	687.6	-0.427	-0.524	-0.313				
S	1	559.2							
SW	89	768.5			-0.249	0.684			-0.266
NW	28	755.0							
October 2005									
Surface									
NE	91	554.4							
SE	47	439.1							
SW	139	535.4							
NW	102	507.7			0.453			0.271	
Midwater									
N	2	191.2							
NE	194	187.8		-0.195			0.244	0.155	
SE	42	135.3							
SW	75	151.5							
NW	56	206.2	0.345						0.278

Table 2-8, continued.

Dates and Direction	N	Average movement (m/hr)	Air temp EC	Wind vel. EC	Wind dir. EC	Precip. EC	Tide pred. MH	Tide Obs. MH	Water temp MH
Bottom									
NE	174	177.8		-0.268	-0.162				
SE	57	148.5							
SW	48	141.4							
NW	90	199.2	0.300						0.330
January 2006									
Surface									
NE	226	182.7	-0.260	0.285					-0.203
SE	111	184.7	-0.474						-0.295
SW	68	243.4	-0.423	0.751	0.509		0.612		
NW	103	187.7		0.660	0.420		0.458		0.246
Midwater									
NE	181	119.4		0.377			0.252		
SE	68	69.5							
SW	95	179.9	-0.392	0.735	0.427		0.617		
NW	146	195.6		0.583	0.408		0.471		0.257
Bottom									
NE	149	114.3		0.353	0.164		0.258		0.201
SE	138	91.5							
SW	92	173.9	-0.358	0.703	0.479		0.533		
NW	129	219.0		0.515	0.334		0.453		0.281
April 2006									
Surface									
N	1	856.8							
NE	268	311.4	0.277	0.354	0.208	0.663		0.235	0.150
SE	148	219.5		0.399	0.261			-0.170	
SW	287	687.8	-0.161	0.607	0.509	0.551		-0.235	-0.235
NW	92	383.2							
Midwater									
NE	279	234.6	0.272	0.348	0.122	0.697		0.227	0.253
SE	225	162.4	0.140	0.312					0.145
SW	179	239.0	0.235						0.225
NW	113	239.6		0.405	0.303			0.314	
Bottom									
NE	224	222.7	0.239	0.272				0.305	0.286
SE	240	164.0	0.263	0.282		0.616			0.211
SW	143	153.3	0.186	0.318	0.183				0.212
NW	189	280.6		0.200	0.198		-0.196		

Table 2-9. Significant ($p \leq 0.05$) Pearson correlation coefficients of the net distance of water movement (m/hr) by net movement direction and vertical position (surface and bottom) recorded by the North River Shallow (1.2 m) ADCP profiler, weather recorded at the Elizabeth City Coast Guard Station (EC), and the tide data at Mann's Harbor (MH) marina for dates indicated. N = number of water movement observations in the direction indicated. Bottom = bins 1-5 (0.31-0.71 m); Surface = bins 6-11 (0.81-1.41 m).

Dates and Direction	N	Average movement (m/hr)	Air temp EC	Wind vel. EC	Wind dir. EC	Precip. EC	Tide pred. MH	Tide Obs. MH	Water temp MH
9/27 - 10/21/05									
Surface									
NE	228	1,023.0						0.205	
SE	273	1,228.0		0.262	0.247			0.199	
SW	66	968.2		0.369	0.315			0.467	
NW	86	981.7	0.307	0.221				0.351	
Bottom									
NE	119	971.6		0.697	0.263				
SE	130	1,215.0	-0.178	0.528	0.385			0.495	-0.284
SW	312	1,045.0	0.185	0.413					
NW	92	871.1	0.420	0.487					0.249
10/21 - 11/11/05									
Surface									
NE	186	844.4	0.291	0.563	0.473			0.225	0.298
SE	134	970.4	0.621	0.437				0.312	0.295
SW	99	802.1	0.402	0.525	0.275		0.239		0.216
NW	61	512.3	0.389	0.387	0.411				0.271
Bottom									
N	47	243.3		0.653	0.353			0.412	0.412
NE	110	248.3	0.520	0.430	0.368		0.217		
S	10	260.5							
SE	58	154.7	0.504	0.585			0.354		0.362
SW	169	279.1	0.240	0.619	0.249			0.382	0.267
NW	86	258.9		0.595	0.476			0.706	

Table 2-9, continued.

Dates and Direction	N	Average movement (m/hr)	Air temp EC	Wind vel. EC	Wind dir. EC	Precip. EC	Tide pred. MH	Tide Obs. MH	Water temp MH
Dec - Jan 2006									
Surface									
NE	271	246.5		0.494	0.214			0.311	-0.184
SE	172	601.1	-0.249	0.901	0.354			0.259	
SW	131	393.2		0.598				0.225	
NW	94	225.8	0.233	0.426				0.288	0.248
Bottom									
NE	272	249.9	0.227	0.574				0.201	
SE	68	798.2		0.364					
SW	199	262.6		0.665	0.305			0.291	0.243
NW	129	249.5		0.475				0.382	

Table 2-10. Significant ($p \leq 0.05$) Pearson correlation coefficients of the net distance of water movement (m/hr) by net movement direction and vertical position (surface, midwater, and bottom) recorded by the Camden Model Location Deep (2.1 m) ADCP profiler, weather recorded at the Elizabeth City Coast Guard Station (EC), and the tide data at Mann's Harbor (MH) marina for dates indicated. N = number of water movement observations in the direction indicated. Bottom = bins 1-5 (0.31-0.71 m); Midwater = bins 6-11 (0.81-1.31 m); Surface = bins 12-16 (1.41-1.81 m)..

Dates and Direction	N	Average movement (m/hr)	Air temp EC	Wind vel. EC	Wind dir. EC	Precip. EC	Tide pred. MH	Tide Obs. MH	Water temp MH
10/21 - 10/27/05									
Surface									
NE	24	208.1		0.557				0.639	
SE	55	304.8		0.585	0.391			0.485	
SW	16	194.7	0.548	0.689				-0.502	
NW	37	209.6							
Midwater									
NE	27	129.7	0.251						
SE	47	241.0			0.332				
SW	16	142.6	0.549					-0.690	0.533
NW	45	197.9							
Bottom									
NE	33	125.0							
SE	39	180.5			0.339		-0.375		
SW	14	169.0							
NW	49	188.7							0.304
12/20/05 - 1/15/06									
Surface									
NE	156	74.7	0.167	0.393					0.336
SE	158	79.0							0.171
SW	130	69.5							
NW	166	79.1	0.153	0.219					0.224
Midwater									
NE	163	48.2							
SE	146	51.9							
SW	129	47.1							
NW	172	55.4							

Table 2-10, continued.

Dates and Direction	N	Average movement (m/hr)	Air temp EC	Wind vel. EC	Wind dir. EC	Precip. EC	Tide pred. MH	Tide Obs. MH	Water temp MH
Bottom									
NE	158	51.7							
SE	174	57.3							
SW	123	58.9					0.189		
NW	155	58.4					0.170		
2/24/2006									
Surface									
SE	4	801.2					-0.981	-0.995	
SW	3	592.9							
Midwater									
SE	7	235.0					-0.953	-0.973	
Bottom									
NE	2	101.6							
SE	4	218.4		0.974					
NW	1	60.2							
5/10 - 6/1/06									
Surface									
NE	135	334.5						No data	-0.178
SE	122	423.6	0.373	0.331	0.351			No data	
SW	96	371.9		0.383	0.311		-0.277	No data	-0.274
NW	190	419.9	0.338					No data	
Midwater									
NE	37	92.0	0.355					No data	
SE	290	292.5	0.274	0.276	0.305			No data	-0.147
SW	82	88.5						No data	
NW	134	151.8	0.219	0.431				No data	
Bottom									
NE	66	94.1						No data	
SE	274	252.7	0.247	0.371	0.328		-0.154	No data	-0.150
SW	71	103.7	0.290					No data	
NW	132	134.2	0.208	0.370				No data	

2-11. Significant ($p \leq 0.05$) Pearson correlation coefficients of the net distance of water movement (m/hr) by net movement direction and vertical position (surface and bottom) recorded by the Camden Model Location Shallow (1.2 m) ADCP profiler, weather recorded at the Elizabeth City Coast Guard Station (EC), and the tide data at Mann's Harbor (MH) marina for dates indicated. N = number of water movement observations in the direction indicated. Bottom = bins 1-5 (0.31-0.71 m); Surface = bins 6-11 (0.81-1.41 m).

Dates and Direction	N	Average movement (m/hr)	Air temp EC	Wind vel. EC	Wind dir. EC	Precip. EC	Tide pred. MH	Tide Obs. MH	Water temp MH
9/27 -10/21/05									
Surface									
NE	68	755.8	0.448	0.337					
SE	188	991.9		0.477	0.472			0.248	
SW	211	1,065.0	0.295	0.453			-0.178		
NW	107	1,014.0	0.527	0.450					0.373
Bottom									
NE	93	308.7							
SE	199	375.0	0.168						-0.189
SW	131	322.5		0.219					
NW	151	416.5		0.254		0.537		0.232	
10/21 - 11/11/05									
Surface									
NE	42	132.9							
SE	294	208.3		0.235	0.154			0.130	
SW	82	118.6	0.299	0.308	-0.267				0.269
NW	93	172.8		0.318					0.244
Bottom									
NE	77	120.2							
SE	230	174.7	0.323	0.235	0.196			0.211	
SW	92	116.7							0.308
NW	112	152.5							
11/11 - 12/20/05									
Surface									
NE	52	432.9							
SE	181	259.8		0.341	0.237			0.264	
SW	68	186.3				0.568			
NW	85	327.5			-0.328	0.734			

Table 2-11, continued.

Dates and Direction	N	Average movement (m/hr)	Air temp EC	Wind vel.EC	Wind dir. EC	Precip. EC	Tide pred. MH	Tide Obs. MH	Water temp MH
Bottom									
NE	159	57.1							
SE	172	56.4				-0.610			
SW	163	51.5							
NW	181	57.6							-0.187
4/1 - 5/6/06									
Surface									
NE	163	48.2							
SE	146	51.9							
SW	129	57.1							
NW	172	55.4							
Bottom									
NE	158	51.7							
SE	174	57.3							
SW	123	58.9					0.189		
NW	155	58.4					0.170		
5/9 - 6/22/06									
Surface									
NE	205	111.4	0.219						
SE	445	224.2	0.247	0.303	0.310				-0.174
SW	80	84.0							
NW	284	159.0	0.248	0.427		0.666			
Bottom									
NE	230	105.7							
SE	333	204.2	0.277	0.277	0.238		-0.173		-0.191
SW	138	111.6							
NW	313	155.6	0.283	0.283					

Table 2-12. The average sediment composition of gravel, sand, silt, clay and organic matter (LOI, Loss on Ignition) found at Camden Model Location (CML), Control, Little River and North River study locations. Numbers for Little River and North River are averaged over both study depths. All numbers are given as percentages. Gravel (coarse fraction) consisted of a combination of shells, sand clumps and organic matter; the * indicates shells only. The ** indicates that the coarse fraction contained sand clumps only.

Location	Site	Gravel	Sand	Silt	Clay	LOI
CML	Diffuser	0.00	72.04	7.28	20.68	28.53
	5 m*E	3.10	80.82	4.10	12.60	20.40
	15 m*E	*0.10	95.26	1.30	3.34	1.28
	25 m*E	0.65	96.20	0.92	2.36	1.07
	5 m*N	*0.75	96.64	0.78	1.98	0.73
	15 m*N	0.72	92.28	2.63	4.48	1.83
	25 m*N	0.92	85.22	6.38	7.48	3.84
	5 m*S	1.48	57.02	6.06	15.44	43.30
	15 m*S	0.98	95.04	0.86	3.12	3.05
	25 m*S	0.66	91.25	3.65	4.55	2.32
	5 m*W	2.73	94.80	0.76	2.26	0.74
	15 m*W	2.52	90.68	2.08	4.72	3.66
	25 m*W	0.24	86.58	6.38	6.80	2.92
	Control		3.90	80.13	7.50	9.12
North River		**0.30	94.50	1.23	4.00	1.64
Little River		*0.21	94.01	2.32	3.49	2.11

CHAPTER 3: SEASONAL CHANGES IN BENTHIC COMMUNITY STRUCTURE
WITH RESPONSES TO A REVERSE OSMOSIS WATER TREATMENT PLANT IN A
NORTH CAROLINA ESTUARY

By

Katharine E. Kleber

Interdisciplinary Program in Biological Sciences

Department of Biology

East Carolina University, Greenville, NC 27858

Abstract

Population growth leads to increased demands for potable water resources; in North Carolina these needs are being addressed through the development of Reverse Osmosis Water Treatment Plants (RO-WTPs), which discharge briny concentrate (waste) into adjacent surface waters. The city of Camden RO-WTP, downstream of Elizabeth City, NC, provided the model to assess the effects of this concentrate on macroinvertebrates. Additional locations included a control location 0.5 km downstream of the Camden Model Location (CML), and two proposed RO-plant discharge locations at the mouths of the Little and North rivers in North Carolina. A total of 21 macroinvertebrate species were found at the four sampling locations. *Leptocheirus plumulosus* (Amphipoda) and *Marenzelleria viridis* (Polychaeta) were the most abundant species collected at all locations and became model organisms at the CML to investigate the effects of the briny discharge on macroinvertebrate distribution around the diffuser pipe. The effect of briny

discharge on the benthic organisms dissipated beyond 5 m. Neither location nor date proved significant when all species were included in the analysis. Benthic communities at these locations were those expected in brackish estuaries of North Carolina, and the diversity found at our study locations was similar. This study establishes a baseline of data for future research at these locations and establishes a method for further investigation of briny concentrate discharge into coastal surface waters.

Introduction

During the 1990s, North Carolina's population increased by 21.7% ranking it ninth in the United States for population growth (United States Census 2007). Between 2000 and 2006, the population increased an additional 10.1% in 20 North Carolina coastal counties, many of which have limited access to fresh surface waters (Waters et al. 2004; United States Census 2007). Many of these coastal counties currently are using the Surficial Aquifer as the primary source of potable (safe to drink) water (NCDENR 2010). This aquifer is sensitive to precipitation, prone to over-wash of seawater, saltwater intrusion from aquifer withdrawal, and contamination from septic systems (NCDENR 2010).

Much of eastern North Carolina has access to the estuarine surface waters of the Albemarle and Pamlico sounds. Salinity within estuaries can vary from fresh (<0.5 ppt), to brackish (0.5-5 ppt), to almost full-strength seawater (32-35 ppt) (Giese et al. 1979; Mitch and Gosselink 2007). The waters in the Sounds are not conducive to potable water processing because of the tannins and lignins, which are byproducts of decaying vegetation, mainly *Taxodium* sp. (Bricaud et al. 1981; Hernes and Hedges 2004; Gallegos 2005; Dobberfuhl 2007). These organic compounds create the characteristic dark-brown

color and give these waters the colloquial name “blackwaters”. It is possible to create potable water using coastal blackwater sources, but these waters would likely exceed the aesthetic standards for total dissolved solids (TDS) (<500 mg/L, U.S. EPA 2006). The total removal of these organics would require ultra filtration, which is cost prohibitive at this time (Hightower 2003). The high TDS levels in potable water may cause problems such as scaling or corrosion of pipes and fixtures, and may also contribute “objectionable tastes” (Younos 2005a). The distillation of ocean water (high TDS) is another option, but becomes more expensive with distance inland with the costs and logistics associated with the transport of ocean waters to inland destinations (Younos 2005b). Because of these limitations, the most cost effective alternative is the development of groundwater resources (Hightower 2003).

Hightower (2003) proposed that desalination of brackish ground water should be more cost effective than finding and developing new freshwater sources. In North Carolina, Reverse Osmosis Water Treatment Plants (RO-WTPs) produce potable water from brackish groundwater, resulting in the discharge of a briny concentrate. Options for disposal include open water/sea disposal (Ahmed et al. 2001), deep well injection (Nicot and Chowdhury 2005), salt production (Ravizky and Nadav 2007) and land disposal (Muhamed et al. 2005). Of these options, the most common disposal method is to discharge it into adjacent surface waters (Ahmed et al. 2001).

One primary consideration in disposing of the concentrate into surface waters is how quickly the discharge water mixes with the ambient surface waters. Hightower (2003) suggested that discharge into adjacent surface waters is "often environmentally benign," although no previous studies have investigated the effects of this discharge on

macroinvertebrates. The Cornell Mixing (CORMIX) model is the primary pre-construction model used to investigate the rate at which the RO plume will dissipate within the receiving waters (CORMIX 2009).

The National Pollution Discharge Elimination System (NPDES), a model developed by the EPA, suggests that briny concentrate such as that produced by RO-WTPs not be discharged into sensitive areas such as estuaries (NPDES 2009). The Clean Water Act of 1972 mandated that ecological integrity be determined and maintained in the Nation's waters. Regulation of total maximum daily loads (TMDLs) is one way of monitoring the pollutants entering a water body, and is one potential method of regulating the brine entering receiving waters. With the longitudinal variations of salinity in estuaries, the best option for monitoring the effects of discharge brine is not TMDLs.

Concerns include ion toxicity (Carmargo and Ward 1992; Douglas et al. 1996), and toxicity of ammonia, nitrite, and nitrate (Alonso and Camargo 2003) all of which can interfere with osmotic regulation in many macroinvertebrate species. It is not only the individual ions that can be a threat, but the ratio of ions to each other. Goodfellow et al. (2000) determined that a high ratio of calcium to sodium (15:1) caused mortality in fathead minnows, *Pimephales promelas*, likely due to changes in the ability to osmoregulate.

Eaton (1994) conducted a study of the benthic macroinvertebrates in Currituck Sound, North Carolina, (Figure 3-1). Biocriteria for monitoring the benthic macroinvertebrates of Currituck Sound were developed using his 1994 data as a model, which was later validated by additional data collections (Eaton 2001). Eaton (1994) was able to cluster macroinvertebrates based primarily on salinity, substrate and submerged aquatic vegetation (SAV).

Salinity and substrate composition are common divisions for investigating species richness, diversity, and biomass (Gunter 1961; Kinne 1966; Tenore 1972; Williams and Williams 1998; Chadwick and Faminella 2001). Strayer and Malcom (2007) studied SAV in the Hudson River estuary and determined that macroinvertebrate density was not influenced by the position of the beds along the river but community composition was strongly influenced by position along the river (salinity gradient). Some studies have chosen to divide the collection sites by salinity ranges and then investigate the populations present within each division (Ysebare et al. 1993; Ieno and Bastida 1998; Ysebare et al. 1998). Others have found that the communities have divided themselves along salinity and/or sediment characteristics. Ysebare et al. (1998) found that diversity decreased with distance upstream (closer to freshwater tidal, <0.5 ppt). Total density did not vary, but biomass was higher in the polyhaline waters (18-30 ppt). They were able to distinguish three salinity ranges: oligohaline, mesohaline and polyhaline. Ysebare et al. (2003) found that hydrodynamics (depth and current velocity) was a primary factor in determining macrobenthos assemblages, with salinity being a second gradient and sediment characteristics (mud content) explaining much of the remaining variability. Sousa et al. (2006) also found that sediment characteristics and salinity explained the majority of the distribution observed in the macrobenthos community of the Lima estuary in Peru.

Many of these studies were conducted over a wide variety of salinities and areas ranging from a single estuary complex (i.e.; Hyland et al. 2004, Pamlico and Albemarle sounds, NC) to multiple estuaries (i.e.; Llansó et al. 2002, including data from the Delaware Bay to the Pamlico Sound). These studies investigated diversity and species richness of benthic communities present in different habitats. Shannon's index of diversity

is often used in diversity studies (Weisberg et al. 1997; Preston 2002; Hyland et al. 2004). Hill's diversity number H' , which is a modification of Shannon's index of biotic diversity (Ludwig and Reynolds 1988) that indicates the number of very abundant species, allows direct comparison of the number of species present at each location (Hill's H') (Ludwig and Reynolds 1988).

Investigating estuarine diversity further leads us to some of the fundamental descriptive variables of ecology and conservation biology: the measures of alpha, beta, and gamma diversity. Alpha diversity is defined as the species richness within a naturally delineated habitat patch. Gamma diversity is the total species richness of a large geographic area, and beta diversity is the change (turnover) of species composition over relatively small distance: adjacent, but recognizably different habitats (Brown and Lomolino 1998). Often these are calculated as inter-related variables. Jost (2007) has proposed that alpha and beta be partitioned to decouple the dependant relationship.

The main objective of my study was to investigate and predict the response of local macroinvertebrate communities to RO-WTP briny discharge in shallow coastal waters; we used Albemarle Sound, North Carolina as the model for the study. The limited movement capability of most benthic macroinvertebrates allows investigation into the effects of chronic exposure of the benthic fauna to local stresses, such as brine disposal (Tagliapietra et al. 2005). Biota provide time-integrated information rather than a “snap-shot” provided by physical and chemical variables normally monitored. My study establishes a baseline of data so that we may observe the response of local macroinvertebrate communities to RO-WTP briny discharge. Based on previous studies illustrated above, it is expected that

salinity will be a dominant factor influencing the macroinvertebrate communities at the study locations.

Study Locations

Albemarle Sound is predominately oligohaline to mesohaline (Hyland et al. 2004, Lin et al. 2007) but exposed to meteorological influences due to its physical orientation with prevailing wind and weather patterns (Figure 3-1). Lin et al. (2007) observed that salinity in Albemarle Sound varies by season, with wind-driven circulation patterns contributing to higher salinities throughout the Sound in the summer.

We chose four locations in Albemarle Sound to determine the effects of briny concentrate discharged into ambient surface waters (Figure 3-1). The RO-WTP for the town of Camden (Camden Model Location, CML) has been operational since 2002 and served as our model of a currently operating RO-WTP. The Camden facility has the capacity to create 2,271 CMD (0.6 MGD) of potable water and the ability to discharge up to 757 CMD (0.2 MGD) of briny concentrate into the Chantilly Bay in the Pasquotank River opposite the US Coast Guard Station at Elizabeth City (Figure 3-2, A). The RO-WTP operates 17-18 hours/day thereby introducing a regular pulse of brine versus a constant stream (24 hours) into the ambient surface waters. A Control location was established 0.5 km downstream of the CML in the same embayment (Chantilly Bay, Figure 3-2, A) of the river to create a site similar to the CML, but without the direct influence of the RO-WTP.

The two other study locations were at the areas of proposed RO-WTP discharge for the counties of Pasquotank and Currituck: at the mouth of the Little River (Pasquotank

County) (Figure 3-2, B) and the North River (Currituck County) (Figure 3-2, C).

Construction guidelines for these two RO-WTPs states that there is the potential at each facility to produce up to 18,900 CMD (5.0 MGD) of potable water while discharging up to 6,322 CMD (1.67 MGD). Adding these two facilities to the list of RO-WT plants represents a doubling of briny discharge volume to North Carolina coastal waters (Table 3-1).

We established 18 study sites among the four study locations. The CML consisted of 13 sampling sites to investigate the effects of the briny concentrate on the resident macroinvertebrates. These 13 sites included a center site at the diffuser pipe along a “N-S” axis, perpendicular to the shoreline and a “E-W” axis parallel to the shore line approximating the 2.1-m contour with the diffuser site located at the center. Along the axes, sites were spaced 5 m, 15 m, and 25 m from the diffuser (Figure 3-3). The Control site was at a depth of 2.1 m. Both the Little River and North River had two sites designated shallow (1.2 m) and deep (2.1 m) to bracket the depth-range of the planned discharges (Figure 3-2, B and C).

Methods

General

We collected benthic samples monthly from July 2005 through June 2006 at each location. We used a Standard Ponar with a footprint of 0.25 m² to collect macroinvertebrates as well as evidence of submerged aquatic vegetation (SAV). With the poor visibility in the ambient blackwaters of Albemarle Sound, visual searches for SAV were ineffective. Evaluation of the presence/absence of SAV in the Little River and North

River locations occurred in August 2005 using side-scan sonar. The effective search area at the mouths of the Little River and North River were approximately 920 m from shore to the shoreline and laterally approximately 920 m to either side of the proposed diffuser site. SAV was easily observed in the visual plots as bright diffuse objects against a darkened background. We found no SAV within the study locations so we do not address SAV coverage further in this manuscript.

Benthic samples were emptied over a 500- μ m stainless steel washing sieve and field-processed using ambient surface water to remove fine sediments. All shells, woody debris and organisms retained by the sieve were preserved in the laboratory with 70% ethanol. All macroinvertebrates were identified to lowest possible taxon and enumerated.

Environmental

Water chemistry was collected using a YSI model 85 handheld multiprobe meter. Measurements were within 0.5 m of the bottom and parameters of interest included water temperature ($^{\circ}$ C), dissolved oxygen (mg/L), percent saturation of oxygen (%), temperature-corrected conductivity (μ S) and salinity (ppt). Water samples also were taken within 0.5 m of the bottom, and were returned to the laboratory for analysis of anion and cation concentrations of the major constituents (chloride, sulfate, calcium, magnesium, potassium, and sodium). Analytical methods were described in Chapter 2. Briefly, we determined the total nitrate + nitrite (NO_3^- - NO_2^- -N) and Orthophosphate (PO_4^{3-} -P) following American Public Health Association (1992) procedures. Ammonia (NH_4^+ -N) concentrations were determined by the phenolhypochlorite method (Solorzano 1969), with all data reported in mg/L (ppm).

We also determined anion (chloride and sulfate) and cation (calcium, magnesium, potassium, and sodium) concentrations from filtered samples, which were compared to standards. The standards used mimicked the proportions and encompassed the ranges expected in the ambient environment. Any sample with concentrations outside the range of the standards was diluted and re-analyzed. Analytical duplicates always yielded results within 10% of one another and usually within 3%.

The salinity data from the anion and cation data were compared to the YSI model 85 data using a Student's t-test. Salinity also was compared among locations to determine if the locations differed significantly. In addition, the complete array of ion data was used to model mineral saturation for each location using PHREEQCI (U.S. Geological Survey 2010). PHREEQCI is a graphical user interface for PHREEQC (Version 2), a low-temperature aqueous geochemical program based on ion-association (Parkhurst and Appelo 1999). This allowed for forecasting of mineral precipitation from the briny discharge entering the surface waters at our study locations.

. The major conservative anions (Cl^- and SO_4^-) closely followed/mirrored those of the major cations (Mg^{2+} , Na^+ , Ca^{2+} and K^+). The main sources of chloride and sulfate present in these samples was seawater (T. Woods, East Carolina University, personal communication) and as such could be predicted based on ratio of the major conservative ions present in seawater and the concentration of sodium.

Camden Model Location (CML)

The two most abundant benthic species present at all locations – *Leptocheirus plumulosus* and *Marenzelleria viridis* – were used to model the response of organisms at

the CML to the briny concentrate. Species count data were natural-log (\log_e) transformed ($\ln(n+1)$) to account for skewness of the data. Transformed data skewness was -0.578 compared to 1.345 for non-transformed data. SPSS v. 17.0.2 (Levesque and SPSS 2007) was used to create plots of the two species encompassing all sample dates, which created a framework for further investigation using SPSS and analysis of variance (ANOVA). Scatter plots of the transformed species numbers were plotted against the environmental variables. Because of a high degree of auto-correlation among the measured environmental variables, such as dissolved oxygen, temperature and percent saturation of oxygen, factor analysis was conducted to investigate the ability of the combined data to better describe the data.

One-way ANOVAs were conducted using the transformed ($\ln(x+1)$) species data against the physical variables of *distance* from the diffuser (5, 15, and 25 m; Figure 3-3), *direction* from the diffuser (E, N, S, or W), and the combined variable of *distance*direction* (i.e.; 5m*E) from the diffuser.

Sediments

We took monthly sediment cores July through December 2005 from all locations. Clear coring tubes were 30.5 cm long and 7.6 cm diameter. We used a 5-cm subsample from the top of each core to analyze for surface grain size distribution and organic content (Loss on Ignition (LOI)). One-way ANOVA was used to investigate the possible relationship between sediment composition at the sites around the diffuser pipe at CML and the distribution of *L. plumulosus* and *M. viridis*.

Date and Location

We assessed different assemblages of macroinvertebrates at the different locations over the course of the sampling year (date of sample) by using two-way crossed ANOSIM (analysis of similarity; Primer v.6, Clarke and Gorley 2006), which tests for differences between groups of community samples (defined *a priori*) using permutation and randomization methods on resemblance matrix. The ANOSIM analysis was conducted with no replicates, which is defined by two factors with zero or one replicates for each of the factor level combinations to investigate the hypothesis that all four locations had the same species assemblages present at each location over the sampling period. All data were natural log (\log_e) transformed ($\ln(n+1)$), and a triangular matrix was achieved by analyzing between samples and creating a Bray-Curtis Similarity matrix (Ysebaert et al. 1998; Weisberg et al. 1997; Long and Seltz 2009).

In addition we were able to produce a dendrogram of similar macroinvertebrate assemblages using hierarchical agglomerative clustering (Clarke and Gorley 2006.). This form of cluster analysis uses a bottom-up approach for clustering similar data by taking the maximum similarity of the individual nodes to create the algorithm for calculating the distance between clusters. A SIMPROF (similarity profile) was run concurrently to test each node of the dendrogram and highlight branches with no remaining structure (Clarke and Gorley 2006).

Diversity

Hill's diversity number NO , represented by S , is the total number of species observed in the samples. Hill's second diversity number, NI , represents the number of very abundant species and is calculated using the equation

$$NI = e^{H'}$$

where H' is Shannon's index (Ludwig and Reynolds 1988), calculated with the equation

$$H' = -\sum(p_i(\ln p_i)),$$

and

$$p_i = n_i/N,$$

where n_i = number of individuals in the i^{th} species (S) and N = total number of individuals in the sample. Hill's NI takes into account the number of individuals and the number of species present at each location, but does not account for the changes in individual species presence. Shannon's index alone gives a decimal number; by converting this index into Hill's NI diversity number (a whole number), we can more easily compare the number of species to the number of very abundant species. The calculation of NI holds some bias because the total number of species in the environment is likely to be greater than the total number of species observed. As the number of individuals increase, there is less weight on rare species, and NI will have a lower value. We calculated these two diversity numbers for all locations by sampling month and location.

Alpha (α), beta (β) and gamma (γ) diversity are inter-related and often expressed by the use of the equation:

$$\gamma = \alpha * \beta.$$

Jost (2007) proposed that this is not an accurate method of illustrating the three measures of diversity, as they are dependent on each other. Based on his research and the fact that the assemblage weights were not equal, we followed his equation for a true alpha as a further modification of Shannon's diversity index:

$${}^1D_{\alpha} = \exp[-w_1 \sum(p_{i1} \ln p_{i1}) + -w_2 \sum(p_{i2} \ln p_{i2}) + \dots + -w_{jn} \sum(p_{in} \ln p_{in})],$$

where D represents the numbers equivalent for that measure of diversity, where p_i is defined above, and w_j = statistical weight of community j (n_j/N). Gamma diversity is represented by Hill's NI (described above as the number of very abundant species) and beta diversity is:

$$D_{\beta} = D_{\gamma}/D_{\alpha}$$

where gamma and alpha are described above. Beta will be smallest when one community dominates and largest when all communities are represented equally. As an additional measure of diversity, Jost (2007) suggested the use of MacArthur's homogeneity measure ($M=1/D_{\beta}$), which is an estimate of the proportion of total diversity found within the average community or sample and explains the proportion of the total diversity that is found on the average community or sample (Jost 2007). This measure will be one if and only if all the samples are the same and will be $1/S$, where S is defined above, when all communities are unique.

Results

General

We collected 21 species from the four study locations from July 2005 through June 2006 (Table 3-2). *L. plumulosus* (Amphipoda), *M. viridis* (Polychaeta) and *Rangia cuneata*

(Bivalvia) were the most abundant species at all locations. Four species unique to the CML were the false dark mussel *Mytilopsis leucohaeta*, nematode worms (Phylum: Nematoda), blue crab *Callinectes sapidus*, and Harris' (white tipped) mudcrab *Rhithropanopeus harrisii*. Two species unique to the North River location included the Syllid family of polychaete worms and the isopod *Edotea montosa*. There were no unique species found at the Little River location.

A total of 15,528 individual organisms were identified over all locations and dates: over 9,000 individuals from CML, 800 from Control, over 4,500 from the Little River, and 900 from the North River. Amphipods were dominant when all four locations were pooled, and represented 54% of the total organisms collected; polychaete worms made up 34% (Figure 3-4, A). There were differences in the number of individuals collected from the four study locations, with CML, Control and Little River having similar percentages of amphipods, polychaetes and "other" (Figure 3-4, B-D). The North River location had considerably more polychaete worms and fewer amphipods (Figure 3-4, E).

Environmental

In general, salinities, based both on the YSI data, were higher at the Little River and North River locations throughout the year (Figure 3-5, Table 3-3). Mean salinities were found to be similar from the CML and Control locations (2-tailed Student's t-test; $\alpha=0.05$, $p = 0.938$, Table 3-4). Salinity was significantly higher at the North River location than CML and Control locations ($p = 0.007$, and $p = 0.012$ respectively). Salinities at the CML and Control locations were not significantly different from the Little River location ($p =$

0.069, and $p = 0.093$ respectively), and the Little River salinities were not significantly different from those of the North River ($p = 0.198$).

The environmental variables measured with the YSI (Table 3-3) and plotted against the (transformed) number of individuals of each species indicated that the relationship was not statistically significant ($p > 0.10$ for all variables). Specifically, when the transformed data were plotted against the salinity, it yielded an $R^2 = 0.122$ for *L. plumulosus* and $R^2 = 0.028$ for *M. viridis* (Figure 3-6), indicating that the relationship between the salinity and the distribution of macroinvertebrates around the diffuse pipe was weak. This weak predictability and the high degree of auto-correlation (i.e.; dissolved oxygen with temperature and percent saturation) of the environmental variables, made them inappropriate for use as covariates in models. Factoring these variables into component factors allowed us to summarize the environmental variables and describe the variability in the macroinvertebrate data. The first factor consisted of auto-correlated salinity with temperature. The second factor consisted of percent saturation of oxygen and dissolved oxygen. These two component factors plotted against the transformed data also yielded a weak relationship. Factor 1 for *L. plumulosus* had an $R^2 = 0.13$ and for *M. viridis*, $R^2 = 0.002$. Factor 2 yielded an $R^2 = 0.007$ for *L. plumulosus* and $R^2 = 0.083$ for *M. viridis*; therefore, both factors were considered weak predictors suggesting that the environmental variables would not likely be the best predictors of variation in the macroinvertebrate distribution around the diffuser pipe.

Camden Model Location (CML)

Box and whisker plots for each species indicated that direction and distance from the diffuser were related to the number of individuals present (Figure 3-7, A and B). ANOVA results indicated that when *distance* from the diffuser was the only variable, *L. plumulosus* abundance was not statistically different ($p = 0.125$) from the diffuser site and 5 m away. All measures are reported as two-tailed p -value with $\alpha = 0.05$ (Table 3-5). Beyond the *distance* of 5 m, abundances of both species were significantly greater ($p < 0.05$) than the diffuser site. The same pattern was not observed for *M. viridis*; abundance remained statistically higher ($p < 0.05$) from that of the diffuser at the 5 m and 15 m *distance*, but was statically similar from the diffuser site at 25 m ($p = 0.103$) (Table 3-5). For all other *distances*, there was a significant difference for abundances of both species when compared to those at the diffuser (Table 3-5).

With *direction* from the diffuser as the only variable, *L. plumulosus* abundance in the west *direction* ($p = 0.057$) was the only direction statistically similar to abundance at the diffuser, and this was not a strong relationship. *M. viridis* abundance was statistically similar to that at the diffuser only in the south *direction* ($p = 0.109$) (Table 3-5); all other *directions*, had significantly higher ($p < 0.05$, Table 3-5) densities for both species with distance from the diffuser.

When both distance and direction were combined (*distance*direction*), some differences in abundance were observed with the two species. For both species, the sites 5m*E ($p = 0.345$, *L. plumulosus* and $p = 0.057$, *M. viridis*) and the 25m*S ($p = 0.848$, *L. plumulosus* and $p = 0.573$, *M. viridis*) were statistically similar in abundance to the diffuser site (Table 3-5). In addition, for *L. plumulosus* the 5m*S site ($p = 0.053$) was statistically

similar to the diffuser site. For *M. viridis*, the 25m*N ($p = 0.191$) and the 15m*S ($p = 0.065$) sites were the only sites statistically similar to the diffuser site (Table 3-5 and Figure 3-8).

Sediments

The sediments taken monthly from July through December 2005 showed little variation over those six months so sediment sampling was suspended after December 2005. At some point during late summer one of the eight diffuser check valves became disengaged from the diffuser pipe. Before we replaced the check valve, a hole approximately 1 m^3 was excavated by the discharge stream. It is possible that the subsequent natural re-filling of this hole led to the increase in organic matter observed at these three sites. Excluding these three sites (July-December 2005) for the CML, sand was the dominant sediment fraction at all locations (Table 3-6). No significant relationship was found between the sediment composition and the distribution of either *L. plumulosus* or *M. viridis* ($p > 0.05$).

Date and Location

The two-way crossed ANOSIM with no replicates indicated differences in species and density (number) across locations (Spearman's Rho = 0.042, Figure 3-9, A) but not date (Spearman's Rho = 0.390, Figure 3-9, B). Using the hierarchical agglomerative clustering we visualized the differences by location (Figure 3-10). The entire CML and the Control location clustered together with greater than 70% similarity based on the species observed at these two locations. The North River and Little River locations were different

from the CML/Control group, although they had a 55% similarity to the CML and Control locations. Three outliers – the North River November 2005, and March 2006; and Control March 2006 – were less than 50% similar to all other dates and locations.

Diversity

The overall number of species (Hill's *NO*) was consistently higher for the CML at all sampling dates than at any other location (Figure 3-11, A). The number of species collected from the CML ranged from six in April 2006 to a high of 17 species in May 2006. Fewer numbers of species were found at the other three locations, with collections ranging from a low of four species in September 2005 to a high of 11 species in June 2006 at the Control location. Numbers of macroinvertebrates similar to those found at the Control location were also observed from the Little River and North River locations. Lows of four and three species, respectively, were collected in November 2005 and the highest numbers of species were 11 from the Little River in June 2006 and nine species from the North River in August 2005 (Figure 3-11, A).

Differences observed between the four locations disappeared when we calculated Hill's *NI* (number of very abundant species) (Figure 3-11, B). The highest values for the number of very abundant species were seen at the CML, Control and North River locations in June 2006, but the greatest number of very abundant species was collected in December 2005 at the Little River location. Also in December, the lowest number of very abundant species was observed at the CML and the Control locations. March collections yielded the lowest number of very abundant species at the Little River and the North River locations (Figure 3-11, B).

A beta diversity of 1.45 indicated that the macroinvertebrate communities were similar across the four study locations, a finding supported by a MacArthur's homogeneity of 0.72. MacArthur's homogeneity indicates the proportion of the total diversity found in the average community and will equal one when these samples are identical.

Discussion

Observed assemblages in my study were similar to that predicted by earlier studies for oligohaline and mesohaline sandy environments (Tenore 1972; Diaz and Schaffner 1990; Eaton 1994; Rakocinski et al. 1997; Eaton 2001; Hyland et al. 2004). However, the unexpected observation of Nematode worm (phylum, Nemertea) fragments at the CML, a generally low salinity environment, was contrary to the taxonomic classification as an estuarine/marine species (Hyland et al. 2004) (Table 3-2).

Many studies have indicated that salinity is a controlling factor for many macroinvertebrate species (Gunter 1961; Kinne 1966; Tenor 1972; Ysebare et al. 1993; Ieno and Bastida 1998; Williams and Williams 1998; Ysebare et al. 1998; Chadwick and Faminella 2001; Ysebare et al. 2003)). In my study, micro-scale salinity at 5, 15, and 25 m from the diffuser measured with a YSI model 85 multiprobe, or by direct measurement of ions, was not a good predictor of differences for the two-model species abundance relative to that at the diffuser. On a larger landscape-scale, we observed differences between the different locations, with salinity being significantly lower at the CML and Control locations compared to the North River location. Perhaps because of these differences in salinity, we also observed differences in the numbers and species present and

the abundance based on location. However, according to the MacArthur's homogeneity number, the species assemblages were very similar across the study locations.

Using the two most numerous species as a model, we best observed the plume effect on the macroinvertebrate community immediately adjacent to the discharge pipe. This effect was most obvious near the diffuser in the east and west directions for both species, likely a proximity effect of the physical construct of the diffuser pipe such that concentrate water entered the ambient water along the east-west axis. Effects observed farther from the diffuser may have been due to the plume not mixing well at the diffuser and then settling to the bottom further out prior to mixture with ambient waters. These results may allow the future use of these two species to investigate the stresses related to chronic exposure by RO briny concentrates (Tagliapietra et al. 2005). Timing of the discharge may have contributed to this effect. The RO-WTP operates 17-18 hours/day thereby introducing a regular pulse of brine versus a constant stream (24 hours) into the ambient surface waters.

The east-west direction corresponded to a problem with the diffuser, which was missing one of the eight check valves at the time of our study. Prior to the check valve replacement, a hole approximately 1 m³ was excavated by the discharge stream. It is possible that the subsequent natural re-filling by stream flow and settling of organic matter into the hole led to the increase in organic matter found at these three sites. Excluding these three sites, the dominant Piper soil texture classification (July-December 2005) for the CML was sand. The Control location sediments classified as sandy loam with a slightly higher percentage of silt and clay. Both the Little River and North River sediments were classified as sand.

We did observe a seasonal variation to the distribution of macroinvertebrate populations observed in other research (Ieno and Bastida 1998, Chadwick and Feminella 2001), but these trends were not statistically different by date or location at our study location. The CML and the Control locations were more similar to each other (>75%) than the North River and Little River locations based on both salinity and hierarchical agglomerative (bottom-up) clustering.

Hill's $N0$ (number of species) was consistently higher at the CML than at any of the other locations. This is likely due to the increased sampling effort (13 sites) at the CML enhancing the probability of collecting the more rare species. Hill's $N1$ (number of very abundant species) was similar over all four locations, supporting the idea of increased sampling effort leading to higher values for $N0$. Other studies (Ieno and Bastida 1998, Preston 2002, and Hyland et al. 2004) have used Shannon's index (H') alone or in conjunction with other similarity indices; however, by using Hill's two indices we were able to make clear comparisons among the study locations in terms of relative (whole) numbers of species.

Conclusion

In summary, there was an effect of the briny concentrate from the diffuser pipe on two abundant species of macroinvertebrates, but the effect dissipated after 5 m. The CML plant has a maximum discharge of 0.200 MGD (757.1 CMD) while the proposed plants have a maximum capacity to discharge 1.67 MGD (6,322 CMD). This is a potential eight-fold increase over CML. With all species combined, date had no significant effect, while location was significantly different: adjacent locations (CML and Control) were similar but

the two future discharge sites were significantly different from the CML/Control group and each other. These results indicate that the Little River and the North River locations are unique in and of themselves. The communities and species may be similar among the locations, but each study location is unique and requires individual evaluation for a period of time post-construction.

Acknowledgements

Very special thanks go to Dr. R. Rulifson and Dr. T. Woods, Co-PIs; and committee members Dr. A. Overton and Dr. E. Reyes. Many grateful thanks to the students of the Rulifson Lab and the Woods Lab for their hours of enthusiastic lab and field assistance. Thank you to Dr. D. Holbert and Dr. K. O'Brien for statistical help. Thank you to the counties of Pasquotank and Currituck, North Carolina, for providing funding. The Institute for Coastal Science and Policy provided lab space and office support.

References

- Ahmed, M., A. Arakel, D. Hoey, M.R. Thurmarukudy, M.F.A. Goosen, M. Al-Haddabi, and A. Al-Belushi. 2001. Feasibility of salt production from inland RO desalination plant reject brine: a case study. *Desalination* 158: 109-117.
- Alonso, A., and J.A. Camargo. 2003. Short-term toxicity of ammonia, nitrite, and nitrate to the aquatic snail *Potamopyrgus antipodarum* (Hydrobiidae, Mollusca). *Bulletin of Environmental Contamination and Toxicology* 70: 1006-1012.
- American Public Health Association. 1998. Standard methods for the examination of water and wastewater, 18th ed.: Washington D.C.
- Bricaud, A., A. Morel, and L. Prieur. 1981. Absorption by dissolved organic matter of the sea (yellow substance) in the UV and visible domains. *Limnology and Oceanography* 26: 43-53.
- Brown, J.H., and M.V. Lomolino. 1989. Independent discovery of the equilibrium theory of island biogeography. *Ecology* 70: 1954-1957.
- Camargo, J.A., and J.V. Ward. 1992. Short-term toxicity of sodium nitrate (NaNO₃) to non-target freshwater invertebrates. *Chemosphere* 24: 23-28.
- Chadwick, M.A., and J.W. Feminella. 2001. Influence of salinity and temperature on the growth and production of a freshwater mayfly in the Lower Mobile River, Alabama. *Limnology and Oceanography* 46: 532-542.
- Clarke, K.R., and R.N. Gorley. 2006. PRIMER v6: User Manual/Tutorial. PRIMER-E, Plymouth, UK.
- CORMIX. 2009. About CORMIX. <http://www.cormix.info/aboutcormix.php>. Accessed July 17, 2010.
- Diaz, R.J., and L.C. Schaffner. 1990. The functional role of estuarine benthos. Pages 25-56 in C.M. Haire and E.C. Krome, editors. *Perspectives on the Chesapeake Bay, 1990*. Chesapeake Research Consortium. CRC Publication No. 136.
- Dobberfuhl, D.R. 2007. Light limiting thresholds for submerged aquatic vegetation in a blackwater river. *Aquatic Botany* 86: 346-352.
- Douglas, W.S., S.S. Grasso, D.G. Hutton, and K.R. Schroeder. 1996. Ionic imbalance as a source of toxicity in an estuarine effluent. *Archives of Environmental Contamination and Toxicology* 31: 426-432.

- Eaton, L. 1994. A preliminary survey of benthic macroinvertebrates of Currituck Sound, North Carolina. *The Journal of the Elisha Mitchell Scientific Society* 110: 121-129.
- Eaton, L. 2001. Development and validation of biocriteria using benthic macroinvertebrates for North Carolina estuarine waters. *Marine Pollution Bulletin* 42: 23-30.
- Gallegos, C.L. 2005. Optical water quality of a blackwater river estuary: the Lower St. Johns River, Florida, USA. *Estuarine, Coastal and Shelf Science* 63: 57-72.
- Giese, G.L., H.B. Wilder, and G.G. Parker Jr. 1979. Hydrology of major estuaries and sounds of North Carolina. U.S. Geological Survey. *Water Resources Investigations* 79-46. 175 p.
- Goodfellow, W.L., L.W. Ausley, D.T. Burton, D.L. Denton, P.B. Dorn, D.R. Grothe, M.A. Heber, T.J. Norberg-King, and J.H. Rodgers, Jr. 2000. Major ion toxicity in effluents: a review with permitting recommendations. *Environmental Toxicity and Chemistry* 19:175-182.
- Gunter, G. 1961. Some relations of estuarine organisms to salinity. *Limnology and Oceanography* 6: 182-190.
- Hernes, P.J. and J.I. Hedges. 2004. Tannin signatures of barks, needles, leaves, cones, and wood at the molecular level. *Geochimica et Cosmochimica Acta* 68: 1293-1307.
- Hightower, M. 2003. Desalination of inland brackish water: issues and concerns. *Southwest Hydrology* 2: 18-19.
- Hyland J.L., W.L. Balthis, M. Posey, C.T. Hackney, and T. Alphin. 2004. The soft-bottom macrobenthos of North Carolina estuaries. *Estuaries* 27: 501-514.
- Ieno, E.N., and R.O. Bastida. 1998. Spatial and temporal patterns in coastal macrobenthos of Samborombon Bay, Argentina: a case study of very low diversity. *Estuaries* 21: 690-699.
- Jost, L. 2007. Partitioning diversity into independent alpha and beta components. *Ecology* 88: 2427-2439.
- Kinne, O. 1966. Physiological aspects of animal life in estuaries with special reference to salinity. *Netherlands Journal of Sea Research* 3: 222-241.
- Levesque, R., and SPSS. 2007. Programming and Data Management for SPSS® Statistics 17.0 A Guide for SPSS Statistics and SAS® Users. Available from http://www.spss.com/statistics/base/ProgDataMgmt_SPSS17.pdf. Accessed July 17, 2010. 594pp.

- Lin, J., L. Xie, L.J. Pietrafesa, J.S. Ramus, and H.W. Paerl. 2007. Water quality gradients across Albemarle-Pamlico estuarine system: seasonal variation and model applications. *Journal of Coastal Research* 23: 213-229.
- Llansó, R.J., L.C. Scott, D.M. Dauer, J.L. Hyland, and D.E. Russell. 2002. An estuarine benthic index of biotic integrity for the mid-Atlantic region of the United States. I. Classification of assemblages and habitat definition. *Estuaries* 25: 1219-1230.
- Long, W.C., and R.D. Seltz. 2009. Hypoxia in Chesapeake Bay tributaries: worsening effects on macrobenthic community structure in the York River. *Estuaries and Coasts* 32: 287-297.
- Ludwig, J.A. and J.F. Reynolds. 1988. *Statistical ecology: a primer on methods and computing*. John Wiley & Sons, Inc., New York. 337 p.
- Mitch, W.J., and J.G. Gosslink. 2007. *Wetlands* Fourth edition. John Wiley & Sons, Inc. Hoboken, New Jersey. 600 p.
- Muhamed, A.M.O., M. Maraqa, and J. Al Handhaly. 2005. Impact of land disposal of reject brine from desalination plants on soil and groundwater. *Desalination* 182: 411-433.
- NCDENR. 2009. North Carolina Aquifers. North Carolina Department of Environment and Natural Resources. Division of Water Quality. http://www.ncwater.org/Education_and_Technical_Assistance/Ground_Water/AquiferCharacteristics/. Accessed July 17, 2010.
- Nicot, J.-P., and A. H. Chowdhury. 2005. Disposal of brackish water concentrate into depleted oil fields: a Texas study. *Desalination* 181: 61-74.
- NPDES. 2009. Fact sheet for NPDES general permit water treatment plants – wastewater discharge summary. <http://www.ecy.wa.gov/programs/wq/wtp/wtpfs.pdf>. Accessed July 17, 2010.
- Parkhurst, D.L., and C.A.J. Appelo. 1999. User's guide to PHREEQC (Version 2) – A computer program for speciation, batch-reaction, one-dimensional transport, and inverse geochemical calculations: U.S. Geological Survey Water-Resources investigations Report 99-4259, 310 p.
- Preston, B.L. 2002. Spatial patterns in benthic biodiversity of Chesapeake Bay, USA (1984-1999): association with water quality and sediment toxicity. *Environmental Toxicology and Chemistry* 21: 151-162.
- Rakocinski, C.F., S.S. Brown, G.R. Gaston, R.W. Heard, W.W. Walker, and J.K. Summers. 1997. Macrobenthic responses to natural and contaminant-related gradients in northern Gulf of Mexico estuaries. *Ecological Applications* 7: 1278-1298.

- Ravizky, A. and N. Nadav. 2007. Salt production by the evaporation of SWRO brine in Eilat: a success story. *Desalination* 205: 374-379.
- Solorzano, L. 1969. Determination of ammonia in natural waters by the phenol hypochlorite method. *Limnology and Oceanography* 14: 799-801.
- Sousa, R., S. Dias, and J.C. Antunes. 2006. Spatial subtidal macrobenthic distribution in relation to abiotic conditions in the Lima estuary, NW of Portugal. *Hydrobiologica* 559: 135-148.
- Strayer, D.L., and H.M. Malcom. 2007. Submersed vegetation as habitat for invertebrates in the Hudson River estuary. *Estuaries and Coasts* 30: 253-264.
- Tagliapietra, D., M. Cornello, and A.V. Ghirardini. 2005. Monitoring transitional waters using reduced benthic assemblages. *Environment International* 31: 1089-1093.
- Tenore, K.R. 1972. Macrobenthos of the Pamlico River estuary, North Carolina. *Ecological Monographs* 42: 51-69.
- U.S. Census. 2007. State and County Quick Facts. North Carolina QuickLinks <http://quickfacts.census.gov/qfd/states/37000.html>. Accessed July 17, 2010.
- U.S. Environmental Protection Agency. 2006. Secondary Drinking Water Regulations: Guidance for Nuisance Chemicals. <http://www.epa.gov/safewater/consumer/2ndstandards.html>. Accessed July 17, 2010
- U.S. Geological Survey. 2010. PHREEQC (Version 2)--A Computer Program for Speciation, Batch-Reaction, One-Dimensional Transport, and Inverse Geochemical Calculations. http://wwwbrr.cr.usgs.gov/projects/GWC_coupled/phreeqc/. Accessed July 17, 2010.
- Waters, B., C.P.G. Richmond, J. Crews-Klein, and J. Renner. 2004. Regional water resource planning - an example from the central coastal plain capacity use area of North Carolina. 2004 American Water Works Association Annual Conference; Orlando, Florida; USA, 13-17 June 2004.
- Weisberg, S.B., J.A. Ranasinghe, L.C. Schaffner, R.J. Diaz, D.M. Dauer, J.B. Frithsen. 1997. An estuarine benthic index of biotic integrity (B-IBI) for Chesapeake Bay. *Estuaries* 20: 149-158.
- Williams, D.D., and N.E. Williams. 1998. Aquatic insects in an estuarine environment: densities, distribution and salinity tolerance. *Freshwater Biology* 39: 411-421.

- Ysebaert, T.P. Meire, D. Maes, and J. Buijs. 1993. The benthic macrofauna along the estuarine gradient of the Schelde estuary. *Netherlands Journal of Aquatic Ecology* 27: 327-341.
- Ysebaert, T.P., P. Meire, J. Coosen, and K. Essink. 1998. Zonation of intertidal macrobenthos in estuaries of Schelde and Ems. *Aquatic Ecology* 32: 53-71.
- Ysebaert, T.P., P.M.J. Herman, P. Meire, J. Craeymeersch, H. Verbeek, and C.H.R. Heip. 2003. Large-scale spatial patterns in estuaries: estuarine macrobenthic communities in the Schelde estuary, NW Europe. *Estuarine Coastal and Shelf Science* 57: 335-355.
- Younos, T. 2005a. Desalination: supplementing freshwater supplies approaches and challenges. *Journal of Contemporary Water Research & Education* 132: 1-2.
- Younos, T. 2005b. The economics of desalination. *Journal of Contemporary Water Research & Education* 132: 39-45.

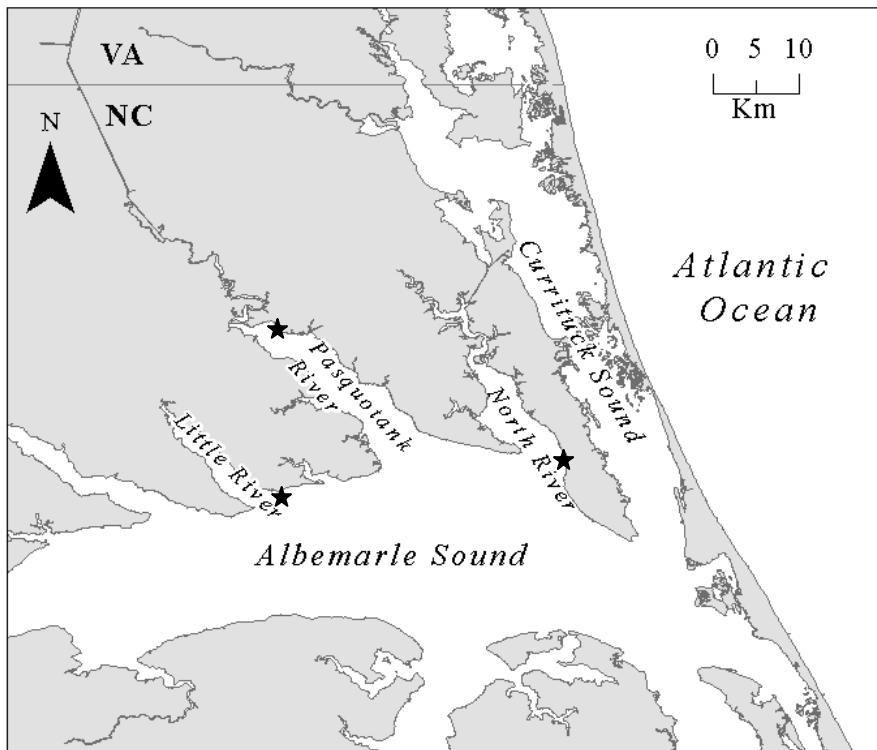
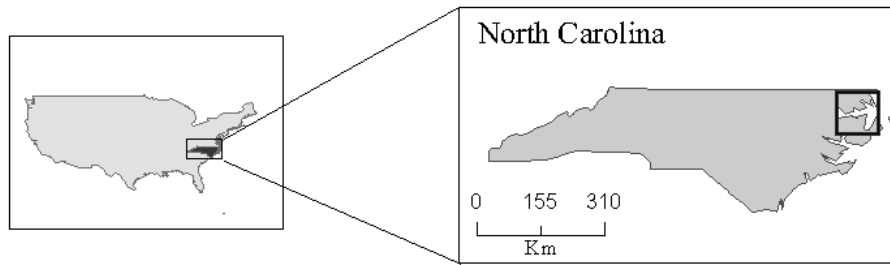

Figure 3-15. Map of study locations, shown by the black stars, and the location of Currituck Sound. Pasquotank River is the placement of the Camden Model Location (CML) and Control location; Little River and North River are the other two sampling locations, which are future sites for briny discharge.

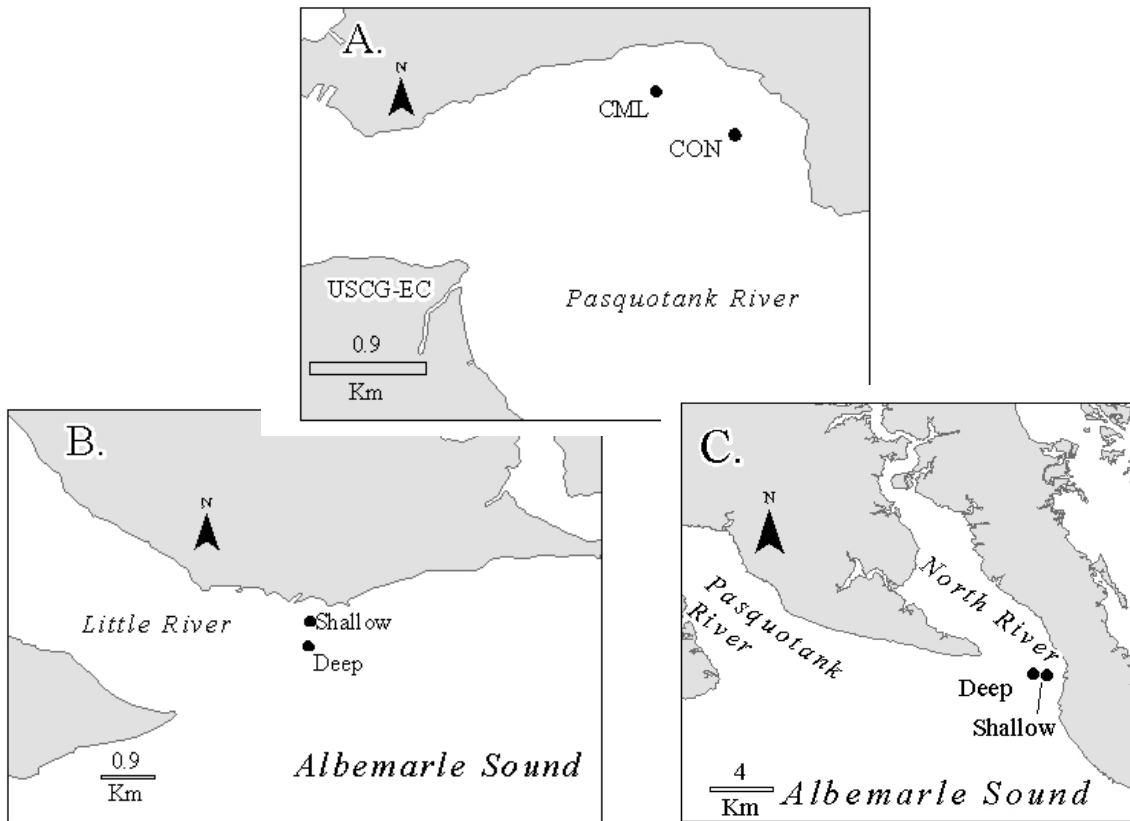

Figure 3-16. Details of study locations: Camden Model Location (CML) and Control locations on the Pasquotank River (A), across from the U.S. Coast Guard station at Elizabeth City (USCG-EC), and the Little River (B) and North River (C) locations, including the shallow (S) and deep (D) sites. Figure 3-3 describes the arrangement of the sampling grid at the CML.

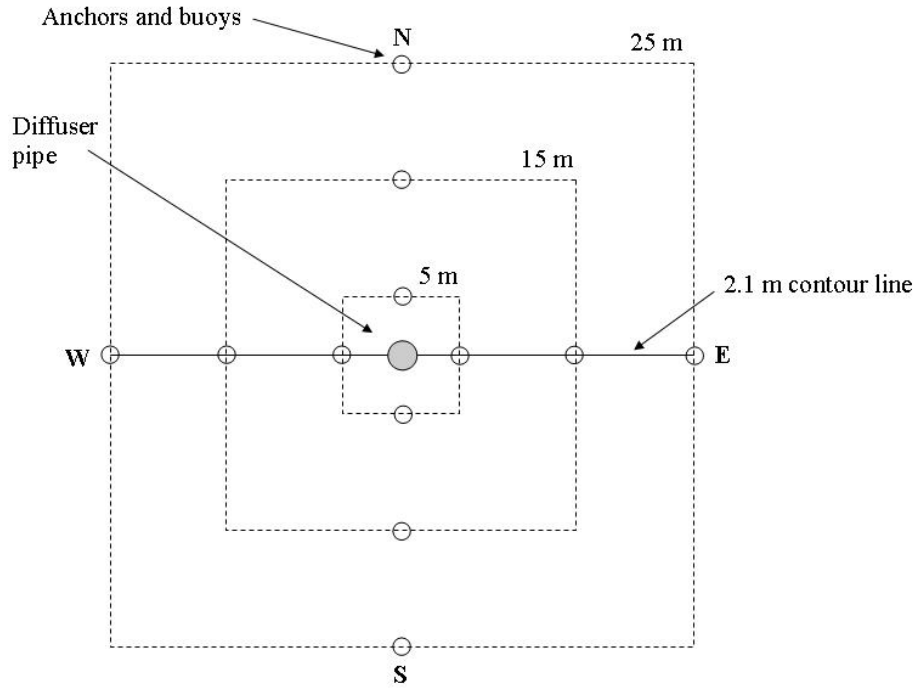

Figure 3-17. Arrangement of sampling grid at Camden Model Location (CML).

N-S and E-W axis were set with the diffuser pipe as the center site and the central E-W axis approximated the 2.1 m contour. 25m*N site was 1.3 m deep and the 25m*S site was 2.7 m deep. Stream flow was generally from “W” to “E.” Total area was 2,500 m².

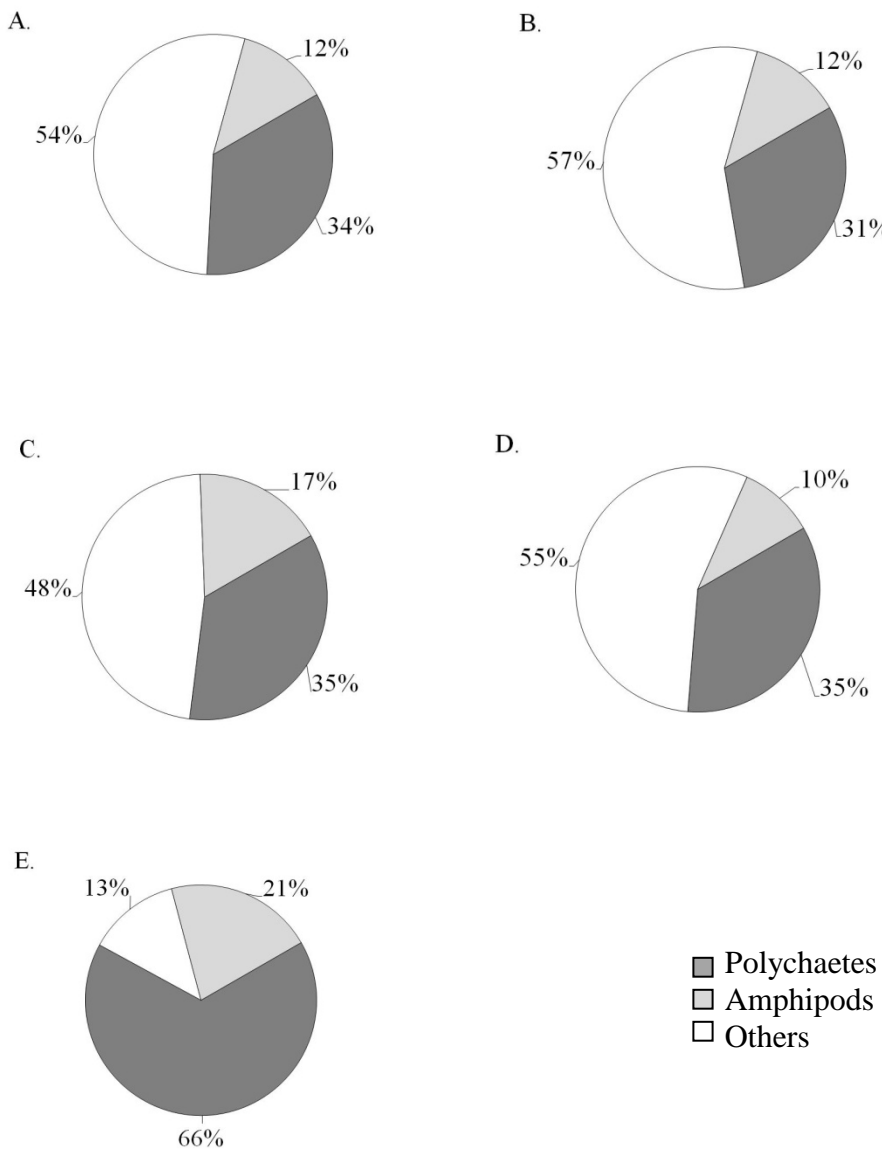

Figure 3-18. Pie charts showing the percentage of polychaetes, amphipods, and other macroinvertebrates (isopods, mystid shrimp, bivalves, insects, nematodes and decapods) at each sampling location A = Overall composition (n = 15,528); B = Camden Model Location (CML, n = 9,250); C = Control location (n = 799); D = Little River location (n = 4,574); E = North River location (n = 905).

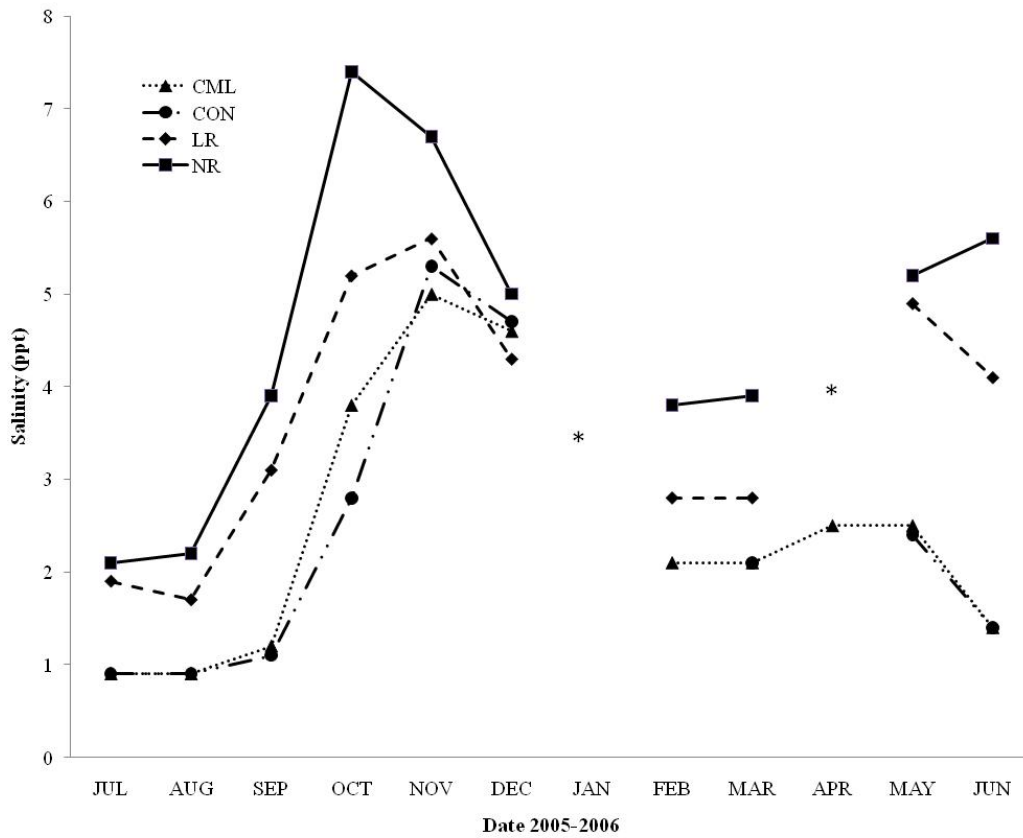

Figure 3-19. Average salinity (ppt) measured by YSI model 85 taken at the four different study locations from July 2005-June 2006. CML=Camden Model Location, CON=Control, LR=Little River, and NR=North River. Asterisk indicates missing data.

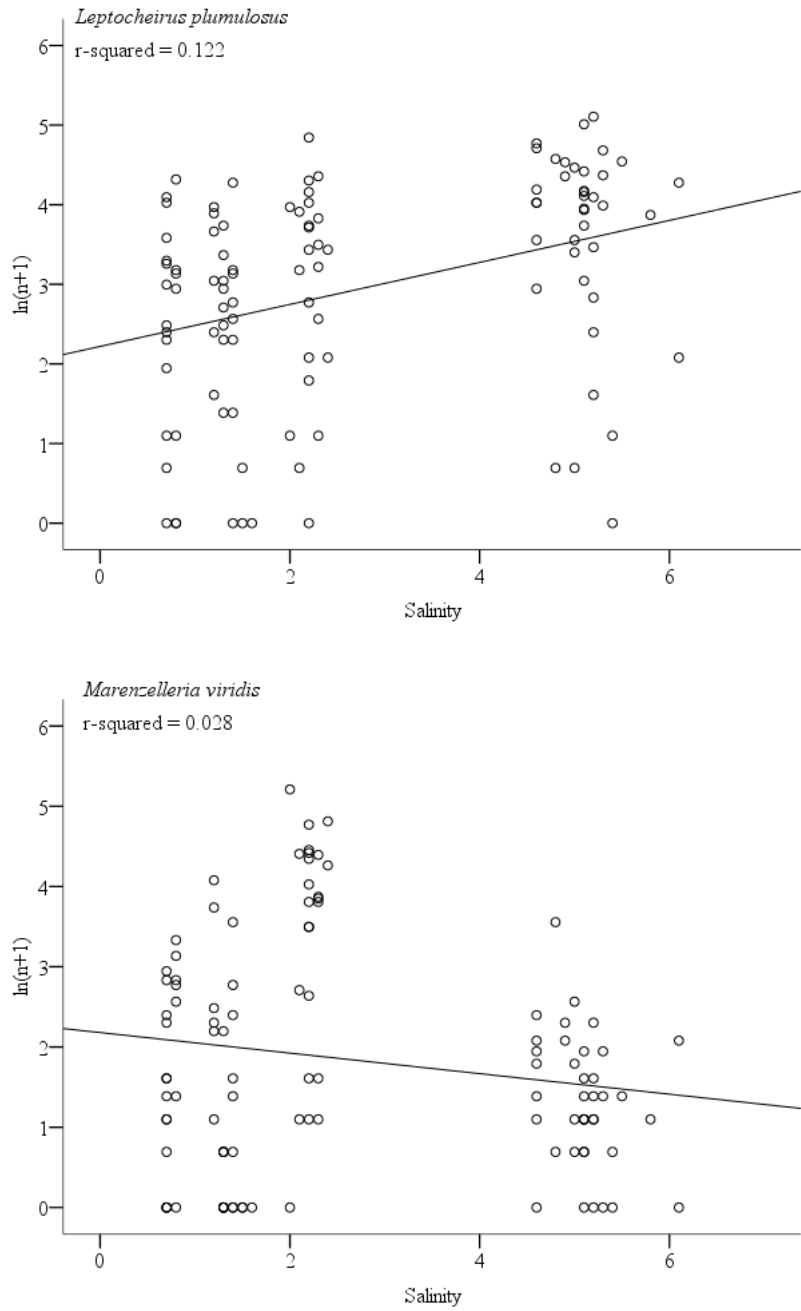

Figure 3-20. Plot of salinity (Na^+ , ppm = mg/L) versus natural log (loge) of the number of individuals ($\ln(n+1)$) for *Leptocheirus plumulosus* and *Marenzelleria viridis* from July 2005-June 2006.

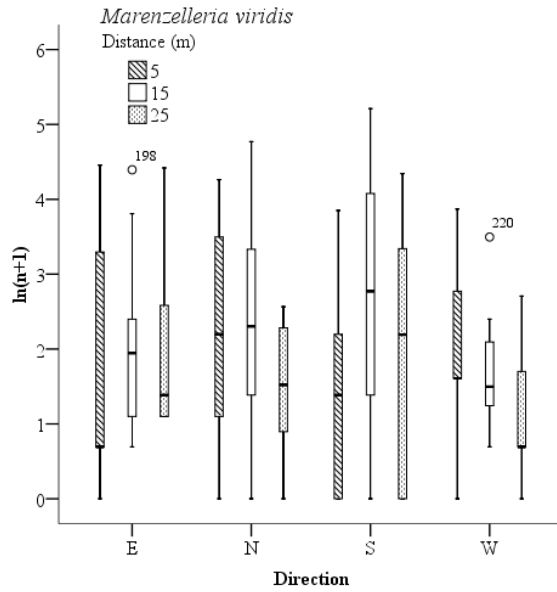
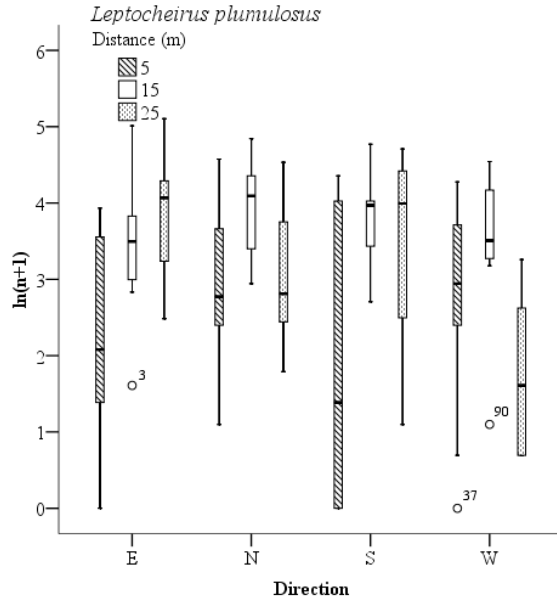

Figure 3-21. Box and whisker plot showing differences in the abundance of *Leptocheirus plumulosus* and *Marenzelleria viridis* in the different directions and at the different distances from the diffuser pipe.

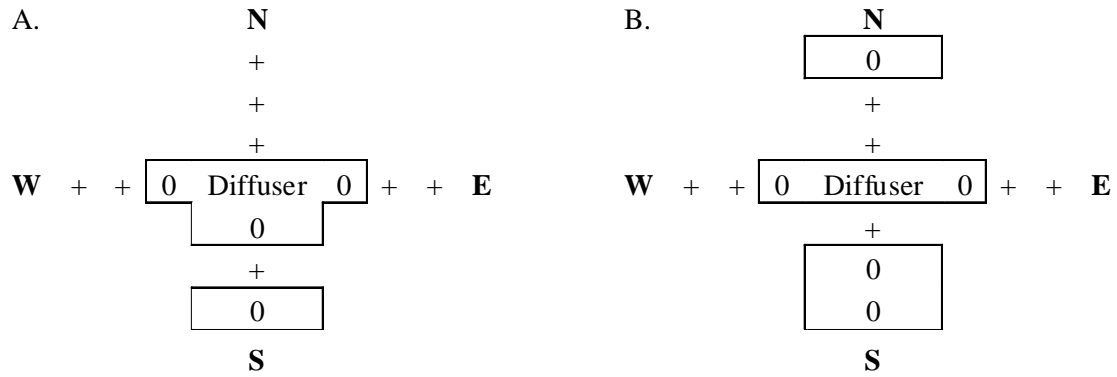

Figure 3-22. A graphical representation of the statistical findings of *distance*direction* at the Camden Model Location (CML) for *Leptocheirus plumulosus* (A) and *Marenzellira viridis* (B); "0" indicates numbers of individuals ($\ln(n+1)$) significantly similar to the diffuser site; "+" indicates a significant increase in numbers from the diffuser.

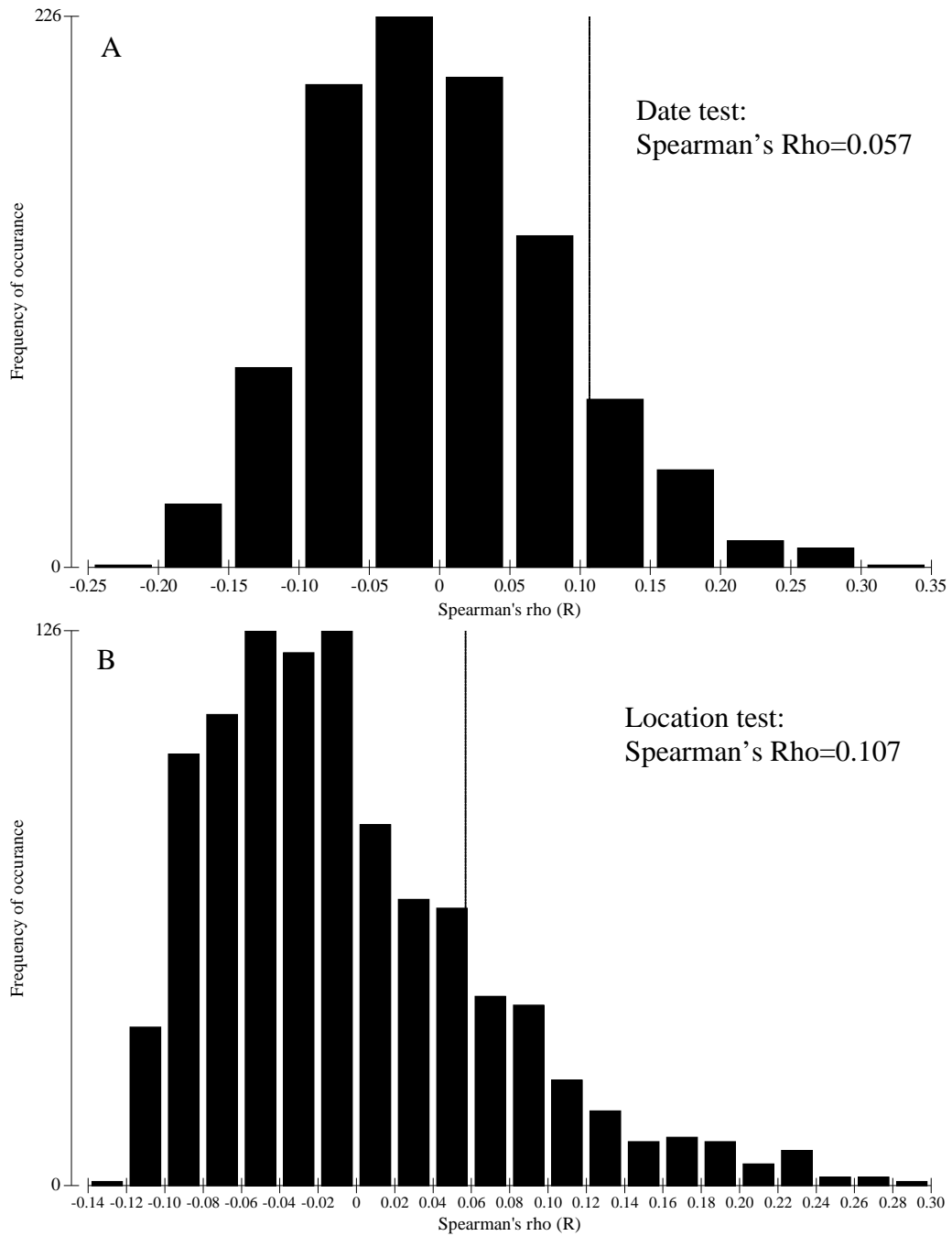

Figure 3-23. ANOSIM-cluster analysis indicating no significant differences for date (A, Spearman's Rho=0.057) and moderately significant differences for location (B, Spearman's Rho=0.107).

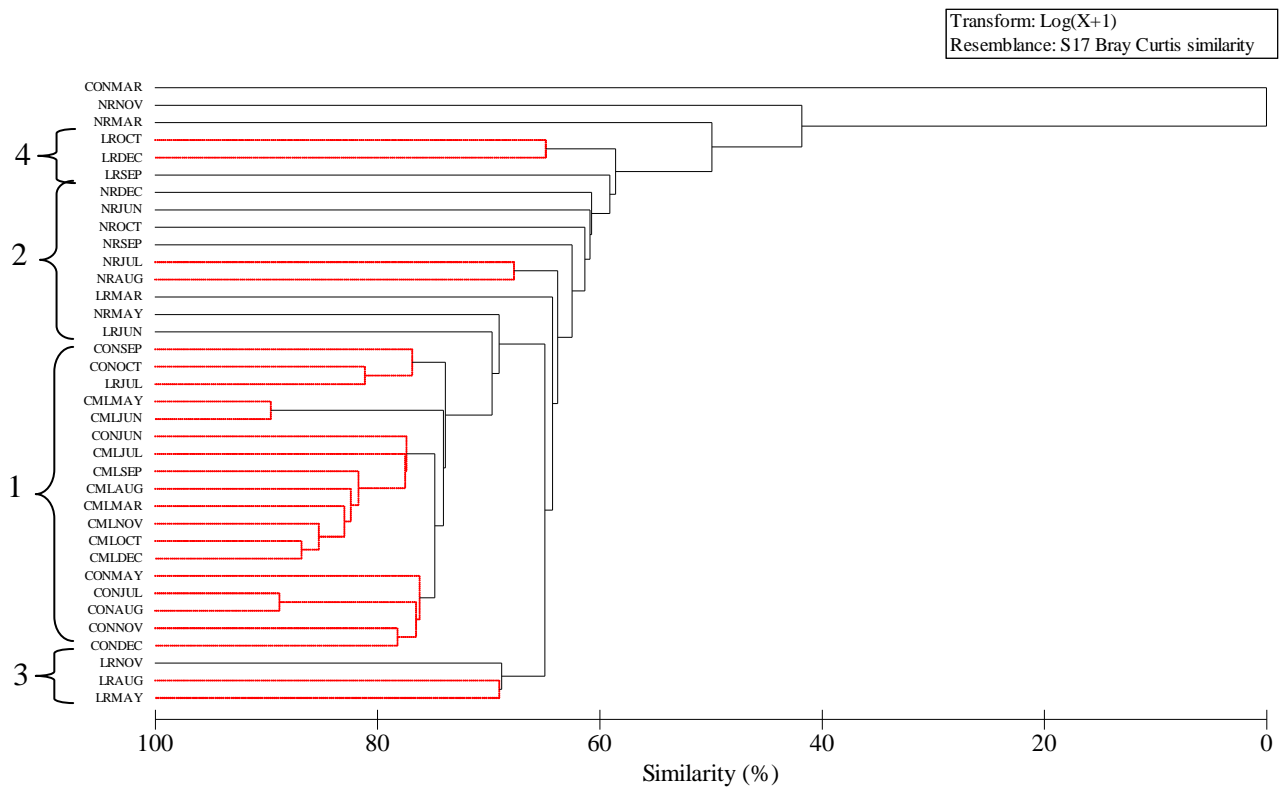

Figure 3-24. Hierarchical agglomerative cluster tree developed from the ANOSIM analysis of location, including all individuals of all species and all dates, showing a clear grouping pattern of the CML and Control (CON) (1), the North River (NR) (2) and Little River (LR) (3, 4). Data were natural log_e (ln(n+1)) transformed. Highlighted branches are those with no remaining structure as determined by SIMPROF (similarity profile) testing of each node of the dendrogram.

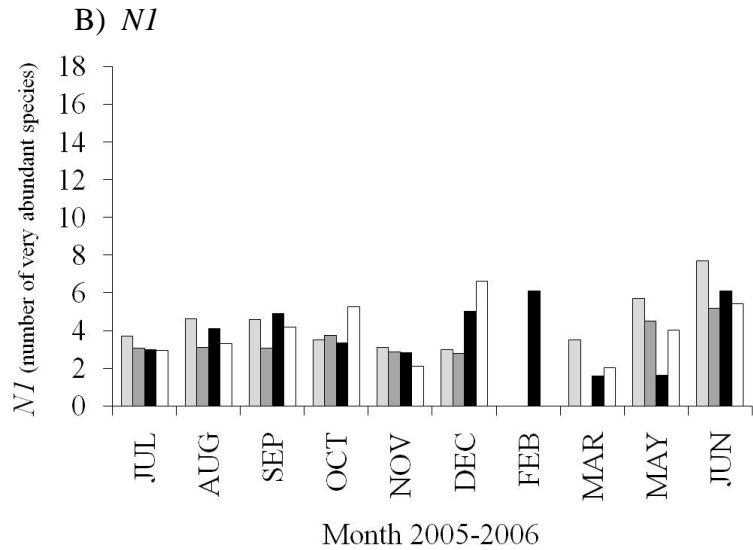
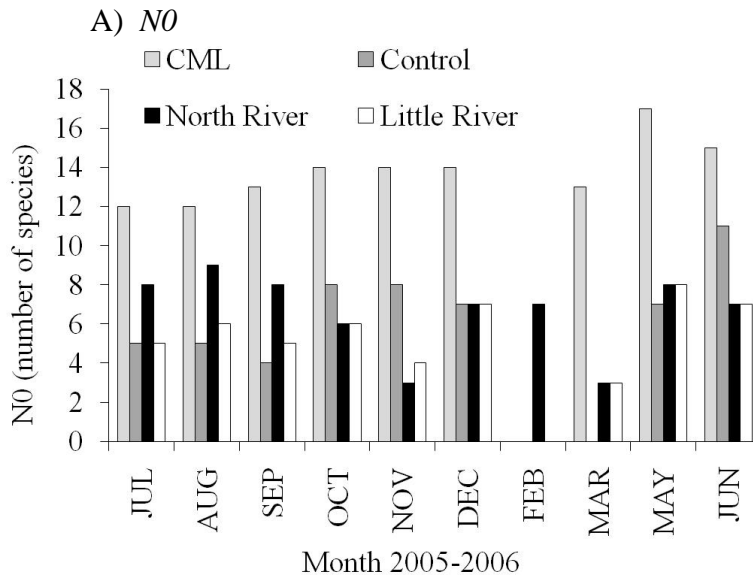

Figure 3-25. Hill's diversity indices for all macroinvertebrate species from July 2005 through June 2006. A) $N0$ =number of species, B) $N1$ =number of very abundant species.

Table 3-13. Current and proposed water treatment plants (WTP) in the state of North Carolina including County in which the plant is located, operation phase, source aquifer, production and discharge rates (cubic meters per day (CMD) and millions of gallons per day (MGD)), receiving body of water and if a preconstruction study was completed. "*" = present study; "***" = Non-Reverse Osmosis WTP.

County	Operation phase	Aquifer(s)	Production		Discharge		Discharge water body	Pre-construction study?
			CMD	MGD	CMD	MGD		
Brunswick	Online	Castle Hayne	583	0.15	227	0.06	Infiltration lagoons (non-discharge)	Yes
New Hanover	-	-	-	-	-	-	-	-
Ocracoke	Online	Castle Hayne	1,961	0.52	1,037	0.27	Pamlico Sound	Yes
# Pasquotank	Proposed	Castle Hayne	18,927	5.00	6,322	1.67	Albemarle Sound	Yes
Tyrrell	Online	Castle Hayne	1,628	0.43	379	0.10	Albemarle Sound	Plume Study
# Currituck	Proposed	Yorktown	18,927	5.00	6,322	1.67	Albemarle Sound	Yes
	Online	Yorktown	3,785	1.00	1,181	0.32	Atlantic Ocean	Yes
Dare	Online	Yorktown	-	-	-	-	Atlantic Ocean	-
	Online	Mid Yorktown	3,785	1.00	2,536	0.67	Pamlico Sound	Yes
	Online	Upper Yorktown	227	0.06	163	0.04	Pamlico Sound	Yes
	Online	Yorktown	7,571	2.00	1,090	0.29	Pamlico Sound	Yes
Hyde	Online	Castle Hayne	1,635	0.43	5,451	1.44	Pungo River (Pamlico Sound) Outfall ditch	Pilot Study
	Online	Yorktown	1,090	0.29	310	0.08	leading to Lake Mattamusket	Pilot Study
Camden	Online	Yorktown, Castle Hayne	2,271	0.60	757	0.20	Pasquotank River	Yes
Totals (current discharges to Sounds)			19,078	5	11,413	3		
Totals (proposed plants only)			37,854	10.00	12,643	3.34		

Table 3-14. Presence, absence, classification and number of macroinvertebrate taxa found from the four study locations in Albemarle Sound, North Carolina from July 2005 through June 2006. "+" = present; "-" = absent from samples.

Group	Species	Camden		Little River	North River	Classification
		Model Location	Control			
Polychaeta	<i>Marenzelleria viridis</i>	1,750	183	1,195	538	Estuarine/marine
	<i>Hobsonia florida</i>	+	+	+	+	Estuarine/marine
	<i>Polydora ligni</i>	+	-	+	+	Estuarine/marine
	<i>Drilonereis longa</i>	+	+	+	+	Estuarine/marine
	Family: Syllid	-	-	-	+	Marine/estuarine
Amphipoda	<i>Leptocheirus plumulosus</i>	4,022	373	715	97	Estuarine
	<i>Monoculodes edwardsi</i>	+	-	+	+	Estuarine
	<i>Parahaustorius</i> sp.	-	-	+	+	Estuarine
	Gammaridae	+	+	-	+	Estuarine
	<i>Corophium</i> sp.	+	+	+	-	Estuarine
Isopoda	<i>Cyathura polita</i>	+	+	+	+	Estuarine
	<i>Chiridotea almyra</i>	+	+	-	+	Estuarine
	<i>Edotea montosa</i>	-	-	-	+	Estuarine/marine
Mysidae	<i>Mysidopdid almyra</i>	+	+	+	+	Estuarine/marine
Bivalvia	<i>Rangia cuneata</i> (>1cm)	+	+	+	+	Estuarine
	<i>Rangia cuneata</i> (<1cm)	+	+	+	+	
	<i>Mytilopsis leucophaeta</i>	+	-	-	-	Estuarine/marine
Insecta	chironomid larvae	+	+	+	+	Estuarine/marine
	Trichoptera larvae	+	+	+	-	Fresh/estuarine
	Nemertean fragment	+	-	-	-	
Decapoda	<i>Rhithropanopeus harrisii</i>	+	-	-	-	Estuarine/marine
	<i>Callinectes sapidus</i>	+	-	-	-	Estuarine/marine
Total number of species		19	13	14	16	
Number of unique species		3	0	0	2	

Table 3-15. Water quality variables temperature (°C), dissolved oxygen (mg/L and percent saturation), temperature-corrected conductivity (µS), and salinity (ppt) taken with a YSI-85 hand-held meter. Data shown are only from measurements recorded from just above the bottom at all sites, and for the entire month at the Camden Model Location.

		% Saturation	DO (mg/L)	Conductivity (µS)	Salinity (ppt)	Temperature (C)
JUL, 2005	Average	100.1	7.67	1,798.6	0.85	28.68
	Maximum	107.0	8.17	2,200.0	1.10	28.90
	Minimum	92.6	7.14	1,556.0	0.80	28.50
AUG, 2005	Average	67.3	5.06	2,153.7	1.08	29.95
	Maximum	84.3	6.35	2,669.0	1.40	30.20
	Minimum	62.3	4.70	1,999.0	1.00	29.70
SEP, 2005	Average	71.6	5.83	2,688.6	1.37	25.02
	Maximum	78.2	6.22	3,043.0	1.60	25.50
	Minimum	62.3	5.22	2,529.0	1.30	24.40
OCT, 2005	Average	57.0	4.98	4,008.4	2.08	21.40
	Maximum	64.8	5.59	5,090.0	2.40	21.40
	Minimum	48.1	4.35	3,662.0	1.90	21.40
NOV, 2005	Average	49.3	4.77	9,343.1	5.27	15.48
	Maximum	69.4	6.65	10,700.0	6.10	15.90
	Minimum	43.1	4.14	8,620.0	4.80	15.10
DEC, 2005	Average	69.1	7.82	8,636.9	4.88	7.25
	Maximum	74.4	8.83	10,510.0	6.10	8.60
	Minimum	60.8	5.25	8,140.0	4.60	6.80
MAR, 2006	Average	74.6	8.42	4,174.4	2.18	9.71
	Maximum	93.2	10.52	4,568.0	2.40	10.10
	Minimum	62.9	7.30	3,918.0	2.00	9.20
APR, 2006	Average	92.0	8.84	4,680.5	2.51	16.08
	Maximum	95.5	9.04	4,794.0	2.60	16.50
	Minimum	88.5	8.66	4,629.0	2.50	15.30
MAY, 2006	Average	82.6	7.08	4,211.7	2.23	22.82
	Maximum	86.1	8.17	4,714.0	2.40	23.10
	Minimum	77.2	6.37	4,115.0	2.20	22.40
JUN, 2006	Average	44.5	3.61	2,503.6	1.30	25.91
	Maximum	48.6	3.93	2,775.0	1.40	26.10
	Minimum	36.6	2.96	2,255.0	1.20	25.60

Table 3-16. Statistical results comparing the salinity of the In-Plant sample just prior to discharge and the salinity of the receiving waters at the study locations determined by two-tailed Student's t-test; $\alpha=0.05$: Camden Model Location (CML), Control (CON), Little River (LR) and North River (NR). All values are Student's two-tailed p-value, $\alpha=0.05$. Asterisk indicates statistical significance.

Sites	In Plant	CON	LR	NR
CML	* <0.001	0.938	0.069	*0.007
CON	* <0.001		0.093	*0.012
LR	* <0.001			0.198
NR	* <0.001			

Table 3-17. Statistical results for the variables of *distance*, *direction* and *distance*direction* effects for *Leptocheirus plumulosus* and *Marenzellira viridis* at the Camden Model Location. Results were determined using a two-tailed Student's t-test, $\alpha=0.05$. A single asterisk is used to indicate the variable *distance*direction*, i.e.; 5m*E. An asterisk associated with the results indicates a value significantly different from the value at the diffuser.

Parent variable	Variable	<i>L. plumulosus</i>	<i>M. viridis</i>
<i>Distance</i> (collapsed over all directions)	5 m	*0.125	*0.043
	15 m	*<0.0001	*0.003
	25 m	*0.006	*0.103
<i>Direction</i> (collapsed over all distances)	E	*0.003	*0.020
	N	*0.001	*0.009
	W	0.057	*0.019
	S	*0.005	0.109
<i>Distance*Direction</i>	5m*E	0.345	0.057
	15m*E	*0.000	*0.007
	25m*E	*<0.0001	*0.018
	5m*N	*0.006	*0.003
	15m*N	*<0.0001	*0.000
	25m*N	*0.005	0.191
	5m*W	0.609	0.392
	15m*W	*<0.0001	*<0.0001
	25m*W	*0.000	*0.022
	5m*S	0.053	*0.016
	15m*S	*0.000	0.065
	25m*S	0.848	0.573

Table 3-18. The average sediment composition (%) of gravel, sand, silt, clay and organic matter (LOI, Loss on Ignition) found at Camden Model

Location (CML), Control, Little River and North River study locations.

Numbers for Little River and North River were averaged over both study depths. Gravel consisted of a combination of shells and organic matter; the single asterisk indicates shells only. The double asterisk indicates that the coarse fraction contained sand clumps only.

Location	Site	Gravel	Sand	Silt	Clay	LOI
CML	Diffuser	0.00	72.04	7.28	20.68	28.53
	5 m*E	3.10	80.82	4.10	12.60	20.40
	15 m*E	*0.10	95.26	1.30	3.34	1.28
	25 m*E	0.65	96.20	0.92	2.36	1.07
	5 m*N	*0.75	96.64	0.78	1.98	0.73
	15 m*N	0.72	92.28	2.63	4.48	1.83
	25 m*N	0.92	85.22	6.38	7.48	3.84
	5 m*S	1.48	57.02	6.06	15.44	43.30
	15 m*S	0.98	95.04	0.86	3.12	3.05
	25 m*S	0.66	91.25	3.65	4.55	2.32
	5 m*W	2.73	94.80	0.76	2.26	0.74
	15 m*W	2.52	90.68	2.08	4.72	3.66
	25 m*W	0.24	86.58	6.38	6.80	2.92
	Control	-	3.90	80.13	7.50	9.12
North River	-	**0.30	94.50	1.23	4.00	1.64
Little River	-	*0.21	94.01	2.32	3.49	2.11

CHAPTER 4: SEASONAL PELAGIC COMMUNITY STRUCTURE IN NORTH
CAROLINA COASTAL WATERS IN RESPONSE TO A REVERSE OSMOSIS WATER
TREATMENT PLANT

By

Katharine E. Kleber

Interdisciplinary Program in Biological Sciences

Department of Biology

East Carolina University, Greenville, NC 27858

Abstract

Demands for potable water resources in eastern North Carolina are being addressed through the development of Reverse Osmosis Water Treatment Plants (RO-WTPs), discharging briny concentrate (waste) into coastal surface waters. Four study locations were sampled during daylight hours in Albemarle Sound to investigate the potential effects of RO-WTP brine on macrozooplankton and nekton at an established RO-WTP and three other locations. Thirteen taxa of macrozooplankton were collected. These taxa showed temporal differences but no spatial differences. Thirty-five species of nekton were collected and Atlantic menhaden (*Brevoortia tyrannus*) was the dominant species collected from all locations. A moderately significant difference (Spearman's Rho = 0.237) of the nekton community was seen by location and a significant temporal difference (Spearman's Rho = 0.669). The MacArthur's homogeneity value for nekton indicated that the communities are similar; the value for macrozooplankton was lower but not low enough to

consider the communities distinctly different. There were greater temporal differences observed than differences based solely on location for both the macrozooplankton and the nekton. There was no evidence that the RO-WTP has a significant impact on either the macrozooplankton or nekton of the area.

Introduction

Albemarle Sound and Pamlico Sound are dominant features of eastern North Carolina. The Sounds are part of the second largest estuarine system in the United States. They are similar to each other in the fact that they are a combination of drowned river valleys and bar-built estuaries and dominated by wind-driven tides (Guise et al. 1979), but different in the sources of inputs to them. Albemarle Sound typically has fringe swamps, which are comprised of cypress (*Taxodium* sp.) trees and permanently flooded conditions. Albemarle Sound's closest direct connection to the Atlantic Ocean is Oregon Inlet at the connection between Albemarle Sound and Pamlico Sound. Freshwater flow from the Roanoke and Chowan rivers dominate, usually creating low salinities (less than 10 ppt) throughout the sound (Bowden and Hobbie 1977; Guise et al. 1979; Lin et al. 2007). Pamlico Sound also has some fringe swamps and freshwater inputs such as the Tar-Pamlico and Neuse-Trent rivers, but it has direct connections to the Atlantic Ocean through several inlets, predominantly Hatteras and Ocracoke inlets. These connections allow for higher salinities in Pamlico Sound and more influence from lunar tides (Bowden and Hobbie 1977; Guise et al. 1979; Lin et al. 2007).

Typical saltmarsh plants are not present in such low salinities, but submerged aquatic vegetation (SAV) such as *Potamogeton* sp. often occurs along the shallow,

protected margins. Losses of SAV have been associated with decreases in fish and waterfowl habitat in Pamlico and Currituck sounds (Stanley 1992). Many juvenile fishes and invertebrates are associated with SAV (Eaton 1994, 2001; Strayer and Malcom 2007). Coastal estuaries and wetlands serve as nursery areas and as sources of food and habitat for juvenile and adult fishes and invertebrates (Johnson 1989; Jude and Pappas 1992; Stanley 1992; Wilcox and Meeker 1992).

The surface waters of Albemarle Sound are suitable for the fish and invertebrates that inhabit the area, but not suitable as a source of potable (safe to drink) water. This is because of the brackish nature of the water also the presence of tannins and lignins (natural dyes) from the decay of the cypress trees in the area (Hernes and Hedges 2004; Gallegos 2005; Dobberfuhl 2007). Because these tannins and lignin are difficult and expensive to remove, the product water is aesthetically unappealing. The local communities are addressing these growing water needs by using Reverse Osmosis-Water Treatment Plants (RO-WTPs) to desalinate the brackish groundwaters. The briny concentrate that remains after processing through a RO-WTP is often discharged into near-by surface waters (Ahmed et al. 2001), though there are other disposal methods available such as open water/sea disposal (Ahmed et al. 2001), deep well injection (Nicot and Chowdhury 2005), salt production (Ravizky and Nadav 2007) and land disposal (Muhamed et al. 2005) among others.

Previous studies of the effects of the briny concentrate have focused on the mixing rate of the brine into the ambient surface waters and have used the CORMIX model to assess this (Rulifson et al. 2006, CORMIX 2009). To date, there have been no published studies as to the effect that this brine may have on the local resident and transient nekton.

In Chapter 3 (this document) it was observed that the briny concentrate from an existing RO-WTP had an effect on macroinvertebrates surrounding the diffuser pipe. This hypothesis was tested by comparing the density differences of two species – *Leptocheirus plumulosus* (Amphipoda) and *Marenzelleria viridis* (Polychaeta) – at the diffuser and sites 5, 15 and 25 m from the diffuser. The effect of the briny concentrate appears to dissipate beyond 5 m from the diffuser (Chapter 3).

Salinity is commonly assumed to define species diversity, richness and biomass (Gunter 1961; Kinne 1966); this assumption has been supported by many (Tenore 1972; Nordby and Zedler 1991; Williams and Williams 1998; Able et al. 2001; Chadwick and Faminella 2001; Preston and Shackleford 2002). Norby and Zedler (1991) found that permanent estuarine residents expressed the widest salinity tolerances with marine nursery species second in regard to salinity tolerance. Contrary to the majority of studies, Greenwood (2007) found “no firm evidence” for division of Tampa Bay and Charlotte Harbor, Florida into salinity zones based on the nekton found in these estuaries.

One concern with the addition of briny effluent is that there is no pre-treatment of the RO-WTP effluent water prior to discharge into the local surface waters. The RO-WTPs of interest in our study are using briny groundwater as source waters and the resulting effluent water is at a constant temperature (typically about 11°C). Therefore, discharge is cooler than ambient surface waters in the summer and warmer in the winter, possibly creating an intermittent thermal refuge; CML actively pumps effluent 17 to 18 hours per day. Also, there are potential changes (both acute and chronic) that may occur from the influx of higher salinity water into the lower salinity waters of Albemarle Sound.

Also of concern are the potential toxicity effects of unusual ion ratios in the discharge brine compared to the receiving waters. Concerns not only include ion toxicity (Camargo and Ward 1992; Douglas et al. 1996; Younos 2005), but also toxicity of ammonia, nitrite, and nitrate (Alonso and Camargo 2003) all of which can interfere with osmotic regulation in many species of fish and macroinvertebrates. It is not only the individual ions that can be a threat, but the ratio of ions to each other that can interrupt normal osmotic functions. A high ratio of calcium to sodium (15:1) caused mortality in fathead minnows, *Pimephales promelas*, likely due to changes in the ability of these fish to osmoregulate (Goodfellow et al. 2000).

In the present study, we investigated the effects of RO-WTP briny effluent on the macrozooplankton and nekton species assemblages in Albemarle Sound. If there is an effect of the briny discharge from the established RO-WTP (Camden Model Location, CML), we would expect to observe a difference in community composition between the CML and the Control locations, with the CML communities being similar to a more saline location such as the Little or North River locations. It is expected that differences in the macroplankton and nekton communities between the study locations will be directly related to salinity, as observed in previous studies. It is expected that the CML and Control communities will be more similar to each other, and the Little River and the North River communities similar to each other and significantly different from the CML and Control locations based on salinity.

Study Locations

We choose four study locations in the Albemarle Sound to determine effects of briny concentrate discharged into ambient surface waters (Figure 4-1). The RO-WTP for the town of Camden, NC (Camden Model Location, henceforth referred to as “CML”) opposite the US Coast Guard Station at Elizabeth City, NC (Figure 4-2, A) has been operational since 2002. This RO-WTP has the capacity to create 2,271 CMD (0.6 MGD) of potable water and up to 757 CMD (0.2 MGD) of briny concentrate discharged into the Pasquotank River. A Control location, established 0.5 km downstream of the CML in the same embayment of the river creates a site similar to the CML, but without the direct influence of the RO-WTP. Two other study locations centered at the areas of proposed RO-WTP discharge in the counties of Pasquotank and Currituck. Each proposed plant has the potential to create 18,900 CMD (5.0 MGD) of potable water and 6,322 CMD (1.67 MGD) of brine. These two study locations were at the mouth of the Little River (Pasquotank County) and the North River (Currituck County) (Figure 4-2, B and C).

Methods

Sampling for both macroplankton and nekton occurred monthly from July 2005 through June 2006 at Camden, Control, North River and Little River. Salinity (ppt) measured with a YSI model 85 hand-held meter was compared to water samples taken concurrently with biological samples and analyzed for chemical composition (Chapter 2). Salinity measurements from both measurements were statistically similar (Chapter 2). Excel and a two-tailed Student’s t-test ($\alpha = 0.05$, $H_0 =$ no difference) were used for comparisons of the different locations.

Macroplankton

Macroplankton samples were collected using paired 0.5-m diameter conical plankton nets of 500- μ m nitex mesh with a 5:1 tail-to-mouth ratio and solid collection cups at the cod end. A bongo frame held the nets, which were towed behind a boat with an outboard motor at 1200 rpm for one minute during daylight hours (established North Carolina Division of Marine Fisheries, NCDMF protocol). Both plankton nets were equipped with a General Oceanics flowmeter to enable calculations of target organism density. Standard water quality parameters were measured and recorded prior to each sample including water temperature ($^{\circ}$ C), salinity, temperature corrected conductivity (μ S), and dissolved oxygen (mg/L and % saturation) using a YSI model 85 hand-held meter. Plankton samples were concentrated into the collection cups, preserved in buffered 10% formalin containing Rose Bengal (a biological stain) and returned to the laboratory for identification to lowest possible taxon.

Nekton

For larger nekton, we used a small-meshed otter trawl (NC Division of Marine Fisheries' (NCDMF) Program 150), with a 3.0 m head rope, provided by the NCDMF. We towed the trawl behind a boat with an outboard motor for one-minute at 1200 rpm during daylight hours (established NCDMF protocol). Trawls were adjacent to the four sampling locations, and we recorded standard water quality parameters prior to each sample. Fish and invertebrates were identified to species, enumerated, and returned them to the laboratory for further analysis.

In addition to the trawl, we used a second capture method for large nekton. Two experimental gillnets were set overnight perpendicular to shore encompassing the sample locations at Camden, Control, North River and Little River. Each experimental gillnet was 38 m long constructed of 5 7.6-m long panels with monofilament webbing of mesh sizes 2.5-, 5-, 7.5-, 10-, and 12.5-cm stretch. Gillnets were deployed in the late afternoon and retrieved the following morning. Water quality parameters listed previously were measured at the surface and bottom before gillnet deployment and after retrieval. We enumerated fish and invertebrates by species and then returned them to the laboratory for further analysis. Once in the laboratory, they were measured (nearest mm) and weighed (nearest gram).

Hill's diversity numbers, NO , and NI (Ludwig and Reynolds 1988) were calculated for all dates and locations. S , the total number of species observed in the samples, represents Hill's diversity number, NO . Hill's second diversity number, NI , represents the number of very abundant species and is calculated by the use of the equation

$$NI = e^{H'}$$

where H' is Shannon's index (Ludwig and Reynolds 1988), calculated by the equation

$$H' = -\sum(p_i(\ln p_i)),$$

where $p_i = n_i/n$; n_i = number of individuals in the i^{th} species (S) and n = total number of individuals in the sample. Shannon's index alone gives a decimal number; the equation $e^{H'}$, converts the decimal to a whole number, allowing comparison of the number of very abundant species to the number of species present in the sample. The calculation of NI holds some bias because the total number of species in the environment is likely to be greater than the total number of species observed; uncertainty increases as the number of

species increases and the distribution of individuals becomes equal. Hill's NI diversity number tends to ignore rare species. As the number of individuals increase there is less weight on rare species, and values of NI will be lower. We calculated both diversity numbers for macroplankton and nekton for all locations by sampling month.

The number of individuals were natural-log (\log_e) transformed ($\ln(n+1)$) to account for the skewness of the data. ANOSIM (PRIMER v. 6; Clarke and Gorley 2006) was used to investigate the relationship between location and date with respect to the $\ln(n+1)$ transformed data for all locations.

Investigating the estuarine continuum further, leads us to some of the fundamental descriptive variables of ecology and conservation biology: the measures of alpha, beta, and gamma diversity. The definition of alpha diversity is the species richness within a naturally delineated habitat patch, gamma diversity is the total species richness of a large geographic area, and beta diversity is as the change (turnover) of species composition over relatively small distance; adjacent, but recognizably different habitats (Brown and Lomolino 1998). Often, these relationships are expressed by the equation:

$$\gamma = \alpha * \beta.$$

Jost (2007) proposed that this is not an accurate method of illustrating the three measures of diversity, as they are dependent on each other. Based on his research and the fact that the assemblage weights were not equal, we followed his equation for a true alpha as a further modification of Shannon's diversity index:

$${}^1D_\alpha = \exp[-w_1 \sum (p_{i1} \ln p_{i1}) - w_2 \sum (p_{i2} \ln p_{i2}) + \dots - w_{jn} \sum (p_{in} \ln p_{in})],$$

where D represents the numbers equivalent of that measure of diversity, where p_i is defined above, and w_j = statistical weight of community j (n_j/N). Gamma diversity is represented

by Hill's NI (described above as the number of very abundant species) and beta diversity is:

$$D_{\beta} = D_{\gamma}/D_{\alpha}$$

where gamma and alpha are described above. Beta will be smallest when one community dominates and largest when all communities are represented equally. As an additional measure of diversity, Jost (2007) suggested the use of MacArthur's homogeneity measure ($M=1/D_{\beta}$), which is an estimate of the proportion of total diversity found within the average community or sample and explains the proportion of the total diversity that is found on the average community or sample (Jost 2007). This measure will be unity if and only if all the samples are the same, and will be $1/S$, where S is defined above, when all communities are unique.

Results

Macroplankton

Average daytime macroplankton abundance and species composition were low at all sample locations with 270 individuals representing 13 taxa collected between June 2005 and June 2006 (Table 4-1). Fish eggs made up 2.1% of the total catch of individuals, though they were not collected at the Control location. Three taxa – Harris' mud crab (*Rhithoropaneopeus harrisii*) zoea (first larval stage), grass shrimp (*Palaemonetes* sp.), and the Cladocera *Leptodora* sp. – made up over 84% of the total catch. *Leptodora* sp. were only collected from the CML and Control locations. Polychaetes and polychaete larvae made up 5.5% of the total catch, though they were not collected from the North River (NR) location. Amphipods, found at all locations, comprised 2.7% of the total (Figure 4-3, A-E).

All other taxa collected were rare, comprising less than 1% each and included: calanoid copepods (NR and Little River, LR), medusa (NR), larval fish (Control and NR), fish eggs (CML, LR and NR), arthropod-fish lice (all except CML), Harris's mudcrab megalope (Control and NR), cyclopoid copepods (CML and LR), clam (LR), isopod (NR), mysid shrimp (NR and LR), mussel (LR), and penaeid shrimp (NR).

Analysis of similarity (ANOSIM) indicated a significant difference in plankton abundance by date (Spearman's $Rho=0.725$) (Figure 4-4, A), but not by location (Spearman's $Rho=-0.064$) (Figure 4-4, B). While the Hill's N_0 , number of species, (Figure 4-5, A.) exhibited some differences in number of taxa by location (higher number of taxa from the North River location), we observed larger differences in the number of species caught over the sampling year, with more species caught in the summer and autumn samples. When we calculated N_1 , the number of very abundant species (Figure 4-5, B.), we observed similar numbers of individuals across dates and location, even though the ANOSIM results by date were significant by species.

A beta diversity of 2.07 indicated that the macroplankton communities were somewhat dissimilar across the four study locations. This is supported by a MacArthur's homogeneity of 0.51.

Nekton

We collected a total of 5,355 individual fish representing 35 species from the four study locations over the course of the study (Table 4-2). Two species made up 71.2% of the total catch: Atlantic menhaden (*Brevoortia tyrannus*) and spot (*Leiostomus xanthurus*). Blue crab (*Callinectes sapidus*) and silver perch (*Bairdiella chrysoura*) comprised 10.5%

of the catch while Atlantic croaker (*Micropogonias undulatus*) rounded out the top five species (Figure 4-6, A). There was not equal representation of these four species at any one location, and all species abundance had a seasonal component. Atlantic menhaden made up 76% of the overall catch from Little River, 62% at Control and about 30% of the catch from both the CML and North River.

There were 719 individuals representing 17 species sampled at the CML, with the four most common species being Atlantic menhaden, spot, blue crab, and white perch (*Morone americana*) (Figure 4-6, B). The CML had the highest numbers of white perch. The abundance peak for these five species was in October 2005 with the exception of white perch, which had a numeric peak in August 2005. There were two unique species found at the CML: golden shiner (*Notemigonus crysoleucas*) and green sunfish (*Lepomis cyanellus*), which are both classified as freshwater species (Table 4-2).

We sampled 21 species, 898 individuals, at the Control location with the four most common species being the same as the CML (Figure 4-6, C). The date-distribution of peak catch was different than that observed at the CML: blue crab in August 2005, white perch and Atlantic menhaden in October 2005, and spot in May 2006. At the Control location, there were four unique species found: yellow perch (*Perca flavescens*), chain pickerel (*Esox niger*), common carp (*Cyprinus carpio*) and pumpkinseed sunfish (*L. gibbosis*), all classified as freshwater species (Table 4-2).

From the Little River location, there were 22 species represented by 2,628 individuals, with the top four species being Atlantic menhaden, spot, blue crab, and silver perch (Figure 4-6, D). Though caught here, white perch ranked seventh in descending order of fish abundance. Peak catches for blue crab were in August 2005, for Atlantic

menhaden and silver perch in October 2005, and spot in June 2006. There were no unique species found at the Little River location.

The North River location had 1,109 individuals representing 26 species. The four most numerous species were Atlantic menhaden, spot, silver perch, and blue crab (Figure 4-6, E). In terms of abundance, white perch ranked eighth at this location. Catch of spot and Atlantic croaker peaked in August 2005, while the other species at this location had peak numbers in March 2006. One species – bay anchovy (*Anchoa mitchilli*) – was uniquely missing from this location. There were also six unique species represented by one individual or one date-observation at this location: spotted seatrout (*Cynoscion nebulosus*), brown shrimp (*Farfantepenaeus aztecus*), white bass (*M. chrysops*), Atlantic silverside (*Menidia menidia*), Atlantic sturgeon (*Acipenser oxyrinchus oxyrinchus*) and red drum (*Sciaenops ocellatus*).

Analysis of similarity (ANOSIM) indicated a significance for fish by date (Spearman's Rho=0.669) (Figure 4-7, A), and a moderate significance by location (Spearman's Rho=0.237) (Figure 4-7, B). Hill's N_0 , number of species (Figure 4-8, A.) and the seasonal pattern of decreasing catch from November 2005 through February 2006 supported the ANOSIM conclusion of a significant difference by date. N_1 , number of very abundant species (Figure 4-8, B.), indicated a higher number of very abundant species present at the North River location from September 2005 through March 2006, which supports the ANOSIM findings of moderate significance by location.

In general, salinities were higher at the Little River and North River locations throughout the year (Figure 4-9). Mean salinities and conductivities were statistically similar between the CML and Control locations (two-tailed Student's t-test; $\alpha = 0.05$; $p =$

0.938; Table 4-3). Salinity and conductivity were significantly higher at the North River location compared to the CML and Control locations ($p = 0.007$ and $p = 0.012$, respectively). The CML and Control locations were not significantly different from the Little River location ($p = 0.069$ and $p = 0.093$, respectively), and the Little River location was not significantly different from the North River ($p = 0.198$).

A beta diversity of 1.38 indicated that the nekton communities were similar across the four study locations. This was supported by a MacArthur's homogeneity of 0.75.

Discussion

The results of our study indicated no observed statistical effect from the briny discharge on the macrozooplankton and nekton communities from the CML and Control locations.

Based on calculated diversity indices, the observed macrozooplankton and nekton communities were similar among all locations. Division of the communities by salinity, as suggested by many (Tenore 1972; Nordby and Zedler 1991; Williams and Williams 1998; Able et al. 2001; Chadwick and Faminella 2001; Preston and Shackleford 2002) was not supported by our results, though salinity was significantly different between locations. The differences in the salinities were apparently not significant enough to have an effect on the observed macrozooplankton and nekton communities at these locations. The macrozooplankton and nekton collected during this study are all species that can typically be observed in oligohaline to mesohaline estuaries.

A seasonal variation in the number of species of both macrozooplankton and nekton was observed, with higher numbers of species observed in summer and lower numbers

observed in the winter. The low numbers of individual macrozooplankton was supported by historically low zooplankton numbers in Albemarle Sound relative to other systems (Rulifson and Manooch 1990; Rulifson et al. 1993) though these previous studies used smaller mesh in order to sample smaller zooplankton.

Macrozooplankton move vertically within the water column on a diel cycle to avoid predation by planktivorous fish (Zaret and Suffern 1976; Williams et al. 1996), and tend to be more abundant at night. Our sampling protocol called for daylight samples of macrozooplankton and this protocol likely had an effect of further reducing the observed zooplankton abundance. In spite of this sampling limitation, we did see species segregation that correlated with salinity. *Leptodora* sp. were collected only at the CML and Control locations, relatively oligohaline areas, while ctenophore medusa and penaeid shrimp were collected only from the North River location, a more mesohaline area.

The observation of larval fish and fish eggs in our samples supports the possibility that these locations may be spawning and/or nursery habitats. There were observations of more brackish/brackish-marine associated fish species present at the Little River and North River locations, and more freshwater-associated species present at the CML and Control locations, but these differences were only moderately significant.

There is no strong evidence to support the hypothesis that the study locations are significantly different based on salinity. There is also no observed effect of the briny discharge on either macrozooplankton or nekton sampled over the one-year of study presented here.

Conclusions

The objective of this study was to investigate the effects of a currently operating RO-WTP (Camden Model Location, CML) on the macrozooplankton and nekton in the area and to compare these data against three other study locations. Based on the information presented here we provide the following conclusions:

- Species of macrozooplankton and nekton were not significantly different between the CML and the Control location, indicating that there is no significant statistical effect of the briny effluent from the CML.
- Larval fish were only collected from the Control and North River locations, indicating that these two locations may be nursery habitats.
- Fish eggs were collected from the CML, the Little River, and the North River locations, supporting the idea that these areas may be spawning or nursery habitats.
- Ctenophore medusa and penaeid shrimp, saltwater-associated macrozooplankton, were collected only from the North River location.
- *Leptodora* sp., a freshwater associated species, was collected only from the CML and Control locations.
- Salinity was significantly different between the Pasquotank River locations (CML and Control) and the North River location.
- From the data collected, there is no indication that nekton and macrozooplankton will be affected by the briny discharge.

Acknowledgments

Special thanks to Dr. R. Rulifson and Dr. T. Woods, Co-PIs; and committee members Dr. A. Overton and Dr. E. Reyes. Thank you also goes to the students of both the Rulifson Lab and the Woods Lab, for their enthusiastic and exhaustive lab and field assistance. Thank you to the counties of Pasquotank and Currituck, North Carolina for providing funding. The Institute for Coastal Science and Policy provided lab space and office support.

References

- Able, K.W., D.M. Nemerson, R. Bush, and P. Light. 2001. Spatial variation in Delaware Bay (U.S.A.) marsh creek fish assemblages. *Estuaries* 24: 441-452.
- Ahmed, M., A. Arakel, D. Hoey, M.R. Thurmarukudy, M.F.A. Goosen, M. Al-Haddabi, and A. Al-Belushi. 2001. Feasibility of salt production from inland RO desalination plant reject brine: a case study. *Desalination* 158: 109-117.
- Alonso, A., and J.A. Camargo. 2003. Short-term toxicity of ammonia, nitrite, and nitrate to the aquatic snail *Potamopyrgus antipodarum* (Hydrobiidae, Mollusca). *Bulletin of Environmental Contamination and Toxicology* 70: 1006-1012.
- Bowden, W.B., and J.E. Hobbie. 1977. Nutrients in Albemarle Sound. North Carolina. Sea Grant Publication No. UNC-SG-75-25. 199 p.
- Brown, J.H., and M.V. Lomolino. 1989. Independent discovery of the equilibrium theory of island biogeography. *Ecology* 70: 1954-1957.
- Camargo, J.A., and J.V. Ward. 1992. Short-term toxicity of sodium nitrate (NaNO₃) to non-target freshwater invertebrates. *Chemosphere* 24: 23-28.
- Chadwick, M.A., and J.W. Feminella. 2001. Influence of salinity and temperature on the growth and production of a freshwater mayfly in the Lower Mobile River, Alabama. *Limnology and Oceanography* 46: 532-542.
- Clarke, K.R., and R.N. Gorley. 2006. PRIMER v6: User Manual/Tutorial. PRIMER-E, Plymouth, UK.
- CORMIX. 2009. About CORMIX. <http://www.cormix.info/aboutcormix.php>. Accessed July 17, 2010.
- Dobberfuhl, D.R. 2007. Light limiting thresholds for submerged aquatic vegetation in a blackwater river. *Aquatic Botany* 86: 346-352.
- Douglas, W.S., S.S. Grasso, D.G. Hutton, and K.R. Schroeder. 1996. Ionic imbalance as a source of toxicity in an estuarine effluent. *Archives of Environmental Contamination and Toxicology* 31: 426-432.
- Eaton, L. 1994. A preliminary survey of benthic macroinvertebrates of Currituck Sound, North Carolina. *The Journal of the Elisha Mitchell Scientific Society* 110: 121-129.
- Eaton, L. 2001. Development and validation of biocriteria using benthic macroinvertebrates for North Carolina estuarine waters. *Marine Pollution Bulletin* 42: 23-30.

- Gallegos, C.L. 2005. Optical water quality of a blackwater river estuary: the Lower St. Johns River, Florida, USA. *Estuarine, Coastal and Shelf Science* 63: 57-72.
- Giese, G.L., H.B., Wilder, and G.G. Parker Jr. 1979. Hydrology of major estuaries and sounds of North Carolina. U.S. Geological Survey. *Water Resources Investigations* 79-46. 175 p.
- Goodfellow, W.L., L.W. Ausley, D.T. Burton, D.L. Denton, P.B. Dorn, D.R. Grothe, M.A. Heber, T.J. Norberg-King, and J.H. Rodgers, Jr. 2000. Major ion toxicity in effluents: a review with permitting recommendations. *Environmental Toxicity and Chemistry* 19:175-182.
- Greenwood, M.F.D. 2007. Nekton community change along estuarine salinity gradients: can salinity zones be defined? *Estuaries and Coasts* 30: 537-542.
- Hernes, P.J., and J.I. Hedges. 2004. Tannin signatures of barks, needles, leaves, cones, and wood at the molecular level. *Geochimica et Cosmochimica Acta* 68: 1293-1307.
- Johnson, D. L. 1989. Lake Erie wetlands: fisheries considerations, pp. 257-273. *In* K. A. Kreiger, editor. *Lake Erie and Its Estuarine Systems: Issues, Resources, Status, and Management*. NOAA Estuary-of-the-Month Seminar Series no. 14, 4 May 1988, Washington D. C.
- Jost, L. 2007. Partitioning diversity into independent alpha and beta components. *Ecology* 88: 2427-2439.
- Jude, D. J., and J. Pappas. 1992. Fish utilization of Great Lakes coastal wetlands. *Journal of Great Lakes Research* 18: 651-672.
- Kinne, O. 1966. Physiological aspects of animal life in estuaries with special reference to salinity. *Netherlands Journal of Sea Research* 3: 222-241.
- Lin, J., L. Xie, L.J. Pietrafesa, J.S. Ramus, and H.W. Paerl. 2007. Water quality gradients across Albemarle-Pamlico estuarine system: seasonal variation and model applications. *Journal of Coastal Research* 23: 213-229.
- Ludwig, J.A., and J.F. Reynolds. 1988. *Statistical ecology: a primer on methods and computing*. John Wiley & Sons, Inc. 337 p.
- Muhamed, A.M.O., M. Maraqa, and J. Al Handhaly. 2005. Impact of land disposal of reject brine from desalination plants on soil and groundwater 182: 411-433.
- Nicot, J.-P., and A. H. Chowdhury. 2005. Disposal of brackish water concentrate into depleted oil fields: a Texas study. *Desalination* 181: 61-74.

- Nordby, C.S., and J.B. Zedler. 1991. Responses of fish and macrobenthic assemblages to hydrologic disturbances in Tijuana estuary and Los Peñasquitos lagoon, California. *Estuaries* 14: 80-93.
- Preston, B. J., and J. Shackleford. 2002. Risk-based analysis of environmental monitoring data: application to heavy metals in North Carolina surface waters. *Environmental Management* 30: 279-293.
- Ravizky, A., and N. Nadav. 2007. Salt production by the evaporation of SWRO brine in Eilat: a success story. *Desalination* 205: 374-379.
- Rulifson, R.A., C.S. Manooch, III (eds.). 1990. Roanoke River water flow committee report for 1988 and 1989. NOAA Technical Memorandum NMFS-SEFC-256.
- Rulifson, R.A., J.E. Cooper, D.W. Stanley, M.E. Shephard, S.F. Wood, and D.A. Daniel. 1993. Food and feeding of young finfish species in the lower Roanoke River, Batchelor Bay, and western Albemarle Sound, North Carolina, 1982-1988. ICMR Contribution Series, No ICMR-93-04, APES Report No. 90-16. 131 p.
- Rulifson, R.A., T.L. Woods, and K.E. Kleber. 2006. Environmental assessment of the Currituck County reverse osmosis water treatment plant discharge site, Albemarle Sound, North Carolina: Final Report. In support of Environmental Assessment Report for Currituck County, Hobbs, Upchurch & Associates, P.A. East Carolina University ICMR Contribution Number 06-04. 129 p.
- Tenore, K.R. 1972. Macrobenthos of the Pamlico River estuary, North Carolina. *Ecological Monographs* 42: 51-69.
- Stanley, D.W. 1992. Historical trends: Water quality and fisheries: Albemarle-Pamlico Sound, with emphasis on the Pamlico River estuary. University of North Carolina Sea Grant College Program. Publication No. UNC-SG-92-04. Institute for Coastal and Marine Resources, East Carolina University, Greenville, NC.
- Strayer, D.L., and H.M. Malcom. 2007. Submersed vegetation as habitat for invertebrates in the Hudson River estuary. *Estuaries and Coasts* 30(2): 253-264.
- Wilcox, D. A., and J. E. Meeker. 1992. Implications for faunal habitat related to altered macrophyte structure in regulated lakes in northern Minnesota. *Wetlands* 12: 192-203.
- Williams, C.E., R.W. Sanders, R.E. Moeller, and P.L. Stutzman. 1996. Utilization of subsurface food resources for zooplankton reproduction: implications for diel vertical migration theory. *Limnology and Oceanography* 41: 224-233.
- Williams, D.D., and N.E. Williams. 1998. Aquatic insects in an estuarine environment: densities, distribution and salinity tolerance. *Freshwater Biology* 39: 411-421.

- Younos, T. 2005. Desalination: supplementing freshwater supplies approaches and challenges. *Journal of Contemporary Water Research & Education* 132: 1-2.
- Zaret, T.M., and J.S. Suffern. 1976. Vertical migration in zooplankton as a predator avoidance mechanism. *Limnology and Oceanography* 21: 804-813.

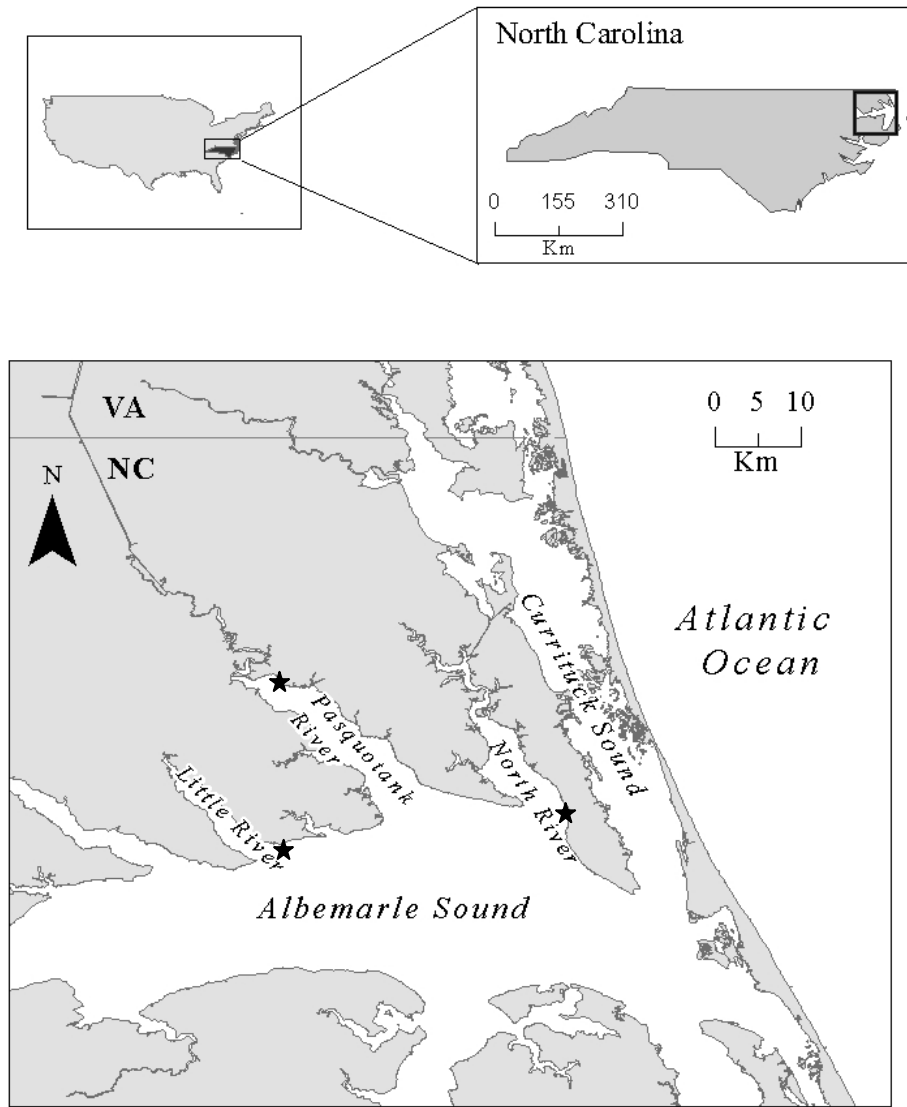

Figure 4-1. Map of study locations, shown by the black stars, and the location of Currituck Sound. Pasquotank River is the placement of the Camden Model Location (CML) and Control location; Little River and North River are the other two sampling locations, which are the future sites for briny discharges.

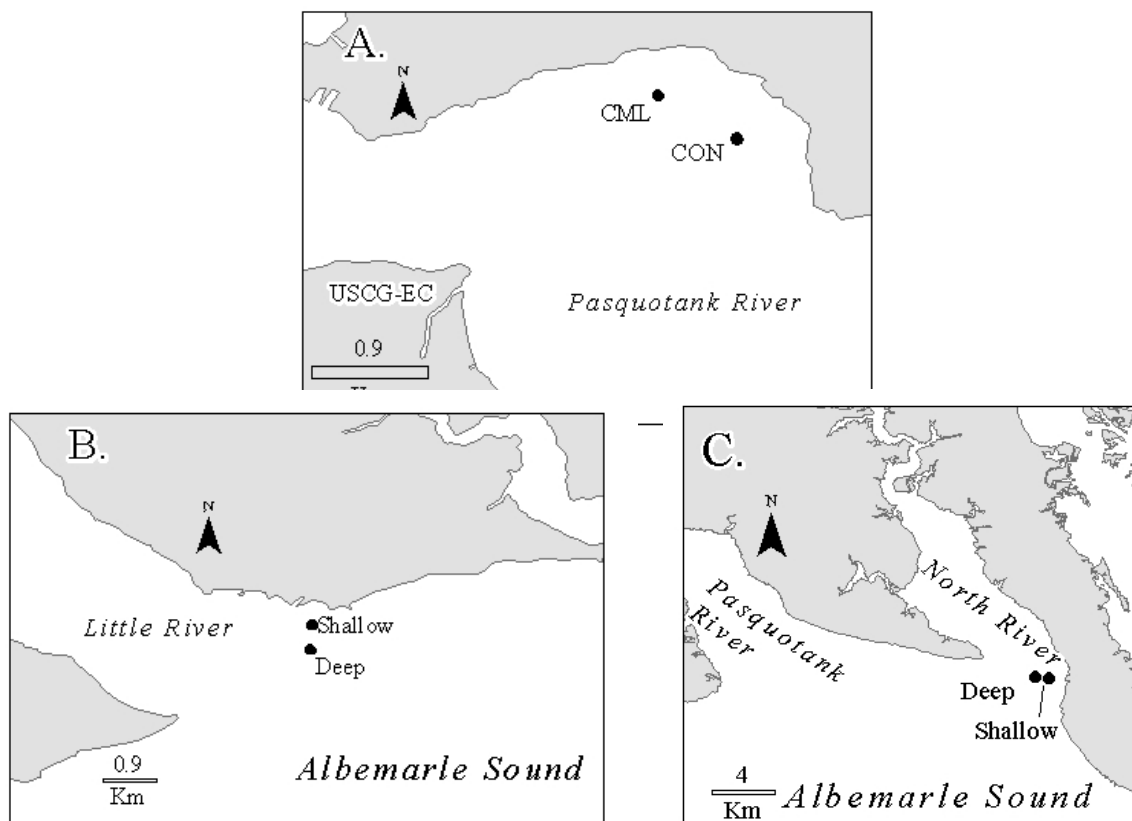

Figure 4-2. Details of study locations: Camden Model Location (CML) and Control locations on the Pasquotank River (A), across from the U.S. Coast Guard station at Elizabeth City (USCG-EC), and the Little River (B) and North River (C) locations, including the shallow (S) and deep (D) sites.

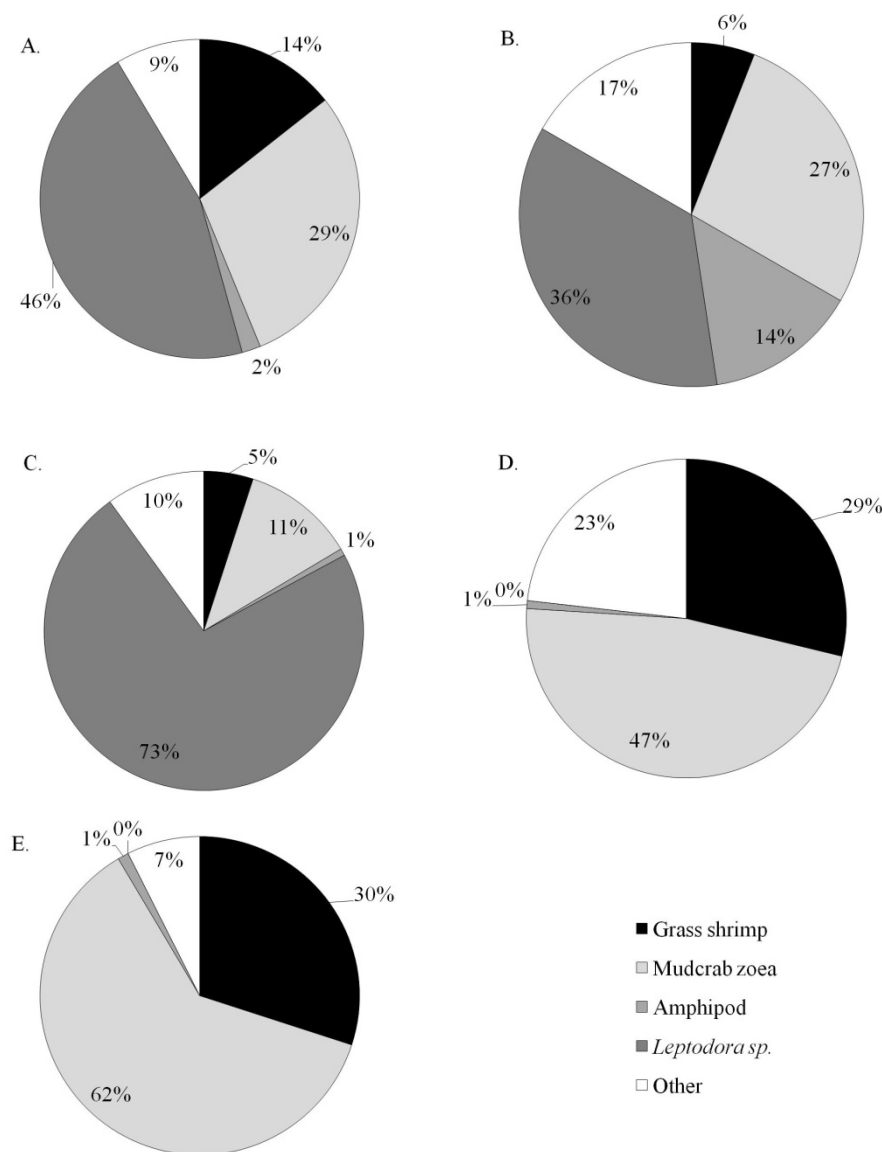

Figure 4-3. Percentage pie-graphs of the four most numerous macrozooplankton species from the study locations: grass shrimp (*Palaeomonetes sp.*), Harris's mudcrab (*Rhithoropaneopeus harrisii*) zoea, *Leptodora sp.*, amphipods (*Gammarus sp.*), and other, including calanoid and cyclopoid copepods, medusa, fish, arthropod-fish lice, Harris's mudcrab megalope, clam, isopod, mysid shrimp, mussel, and penaeid shrimp. A. Overall, B. Camden Model Location (CML), C. Control, D. Little River, and E. North River.

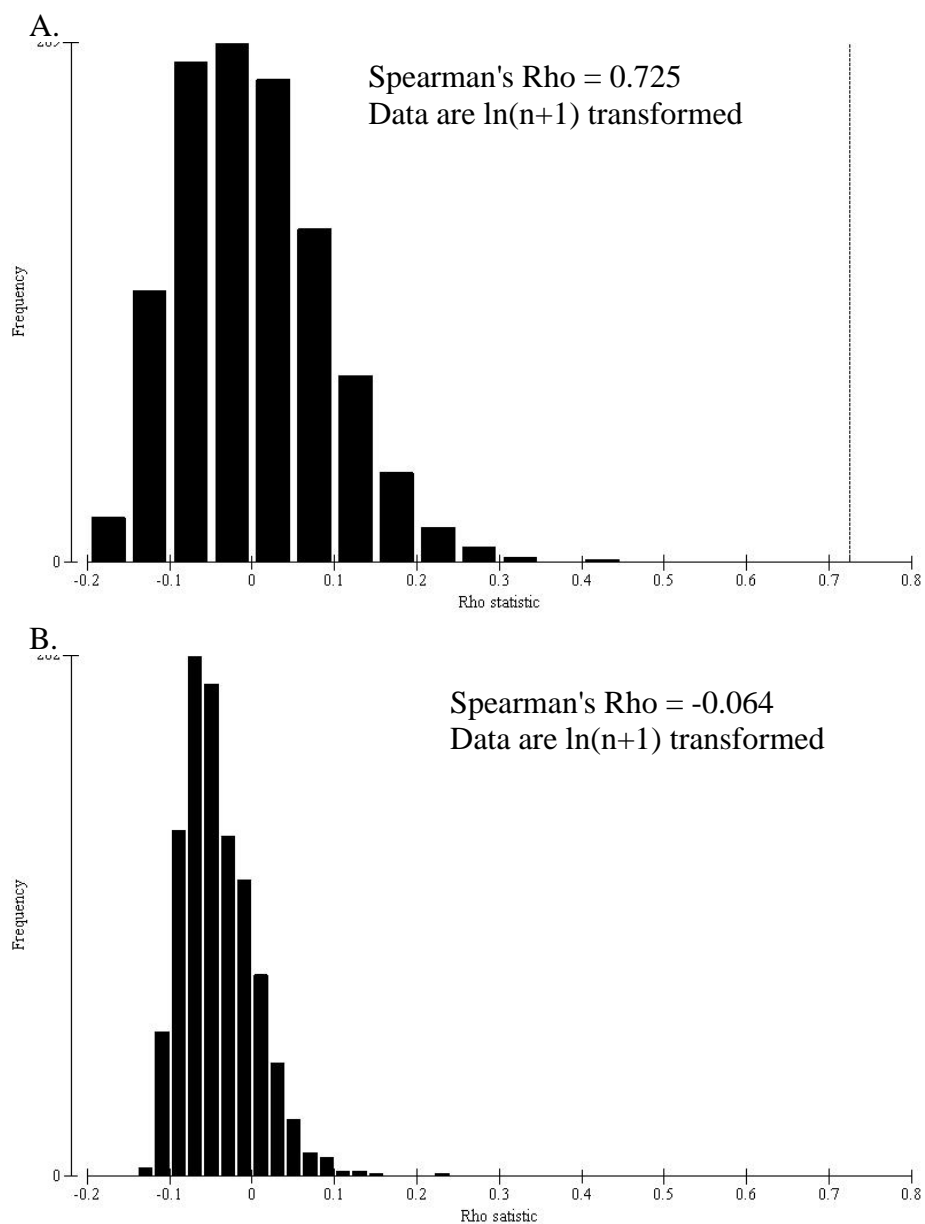

Figure 4-4. ANOSIM analysis for zooplankton taxa data indicating significant differences for date (A, Spearman's Rho = 0.724) and no significant differences for location (B, Spearman's Rho = -0.064, line is not visible under the data).

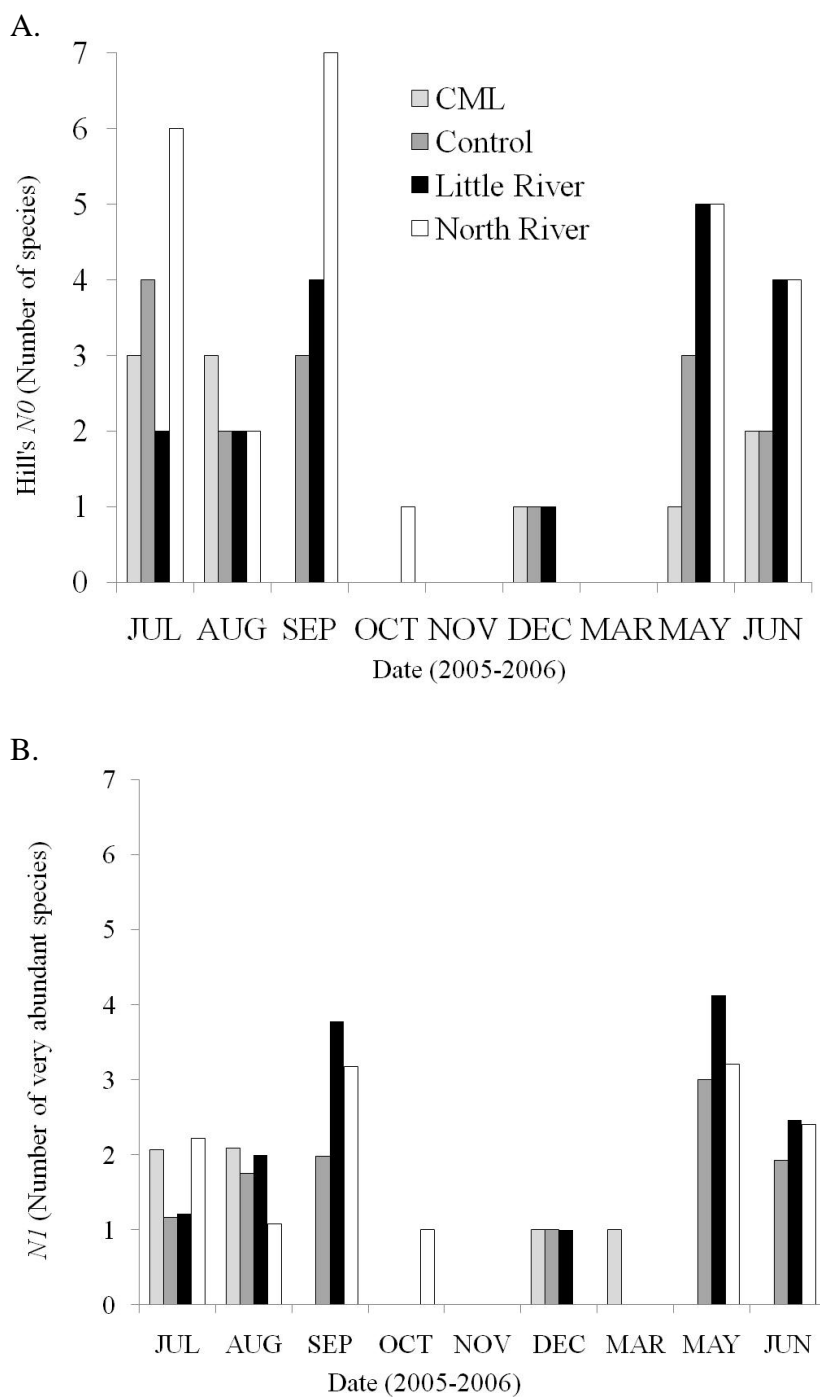

Figure 4-5. Hill's N_0 (A., number of species) and N_1 (B., number of very abundant species) of zooplankton sampled over the sampling dates, 2005-2006. CML=Camden Model Location.

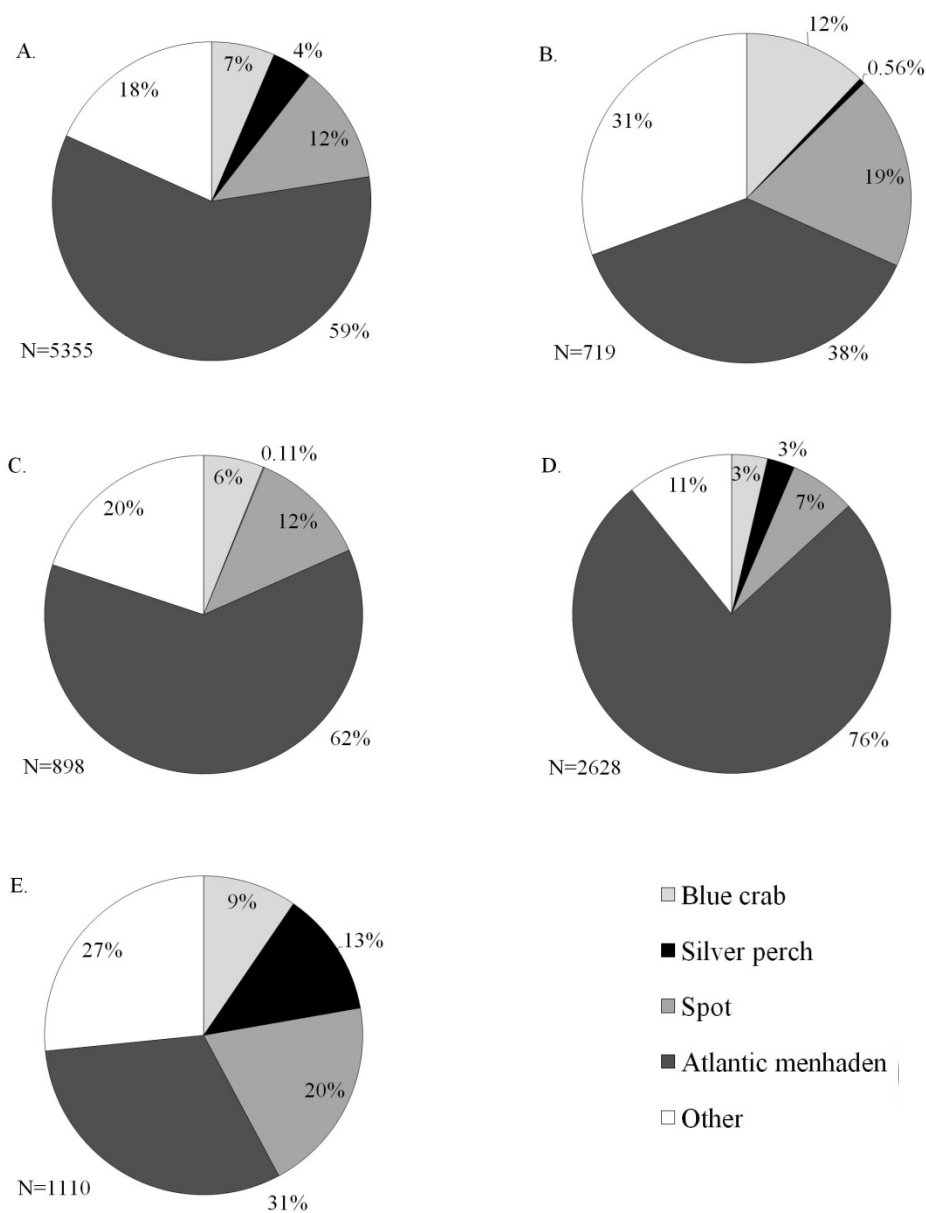

Figure 4-6. Percentage pie-graphs of the four most numerous nekton species from the study locations. A. Overall, B. Camden Model Location (CML), C. Control, D. Little River, and E. North River.

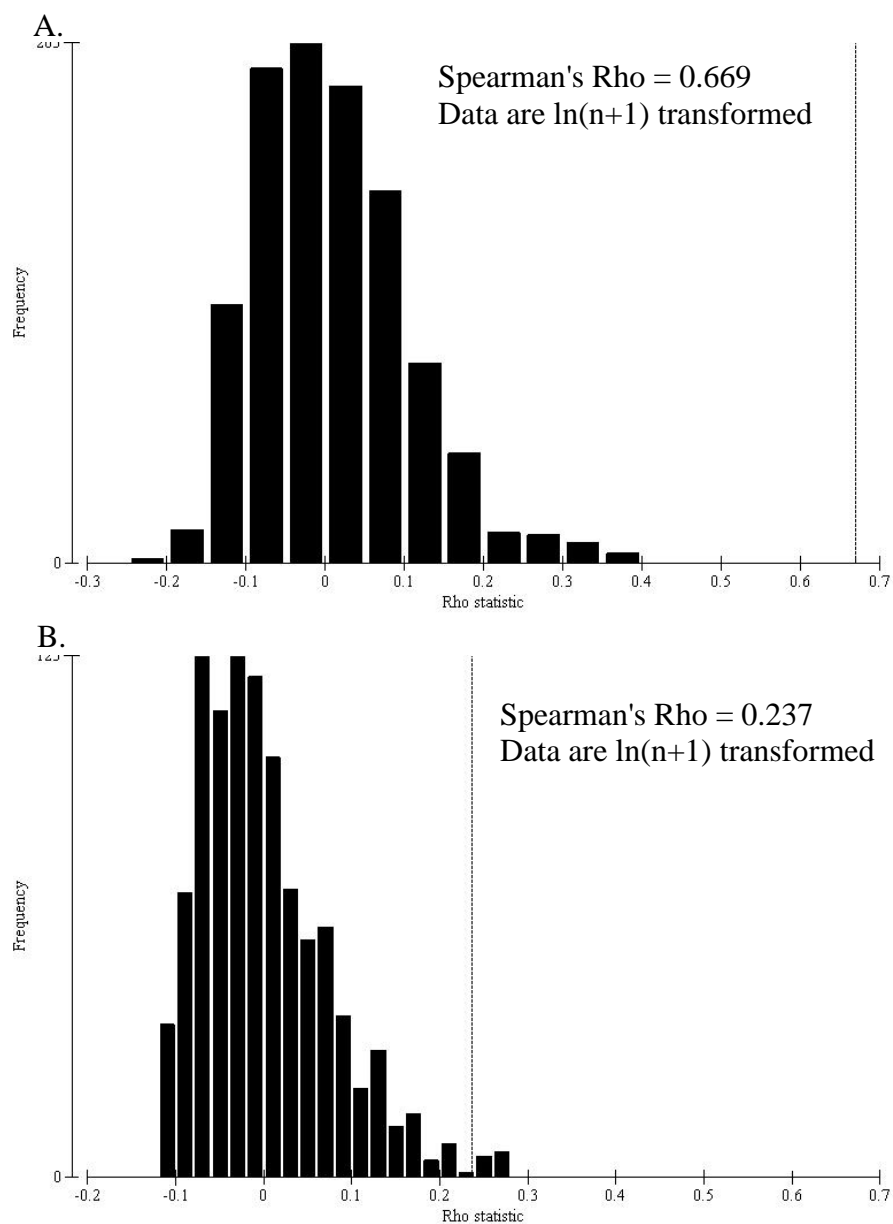

Figure 4-7. ANOSIM analysis of fish species data indicating significant differences for date (A, Spearman's Rho = 0.669) and moderately significant differences for location (B, Spearman's Rho = 0.237).

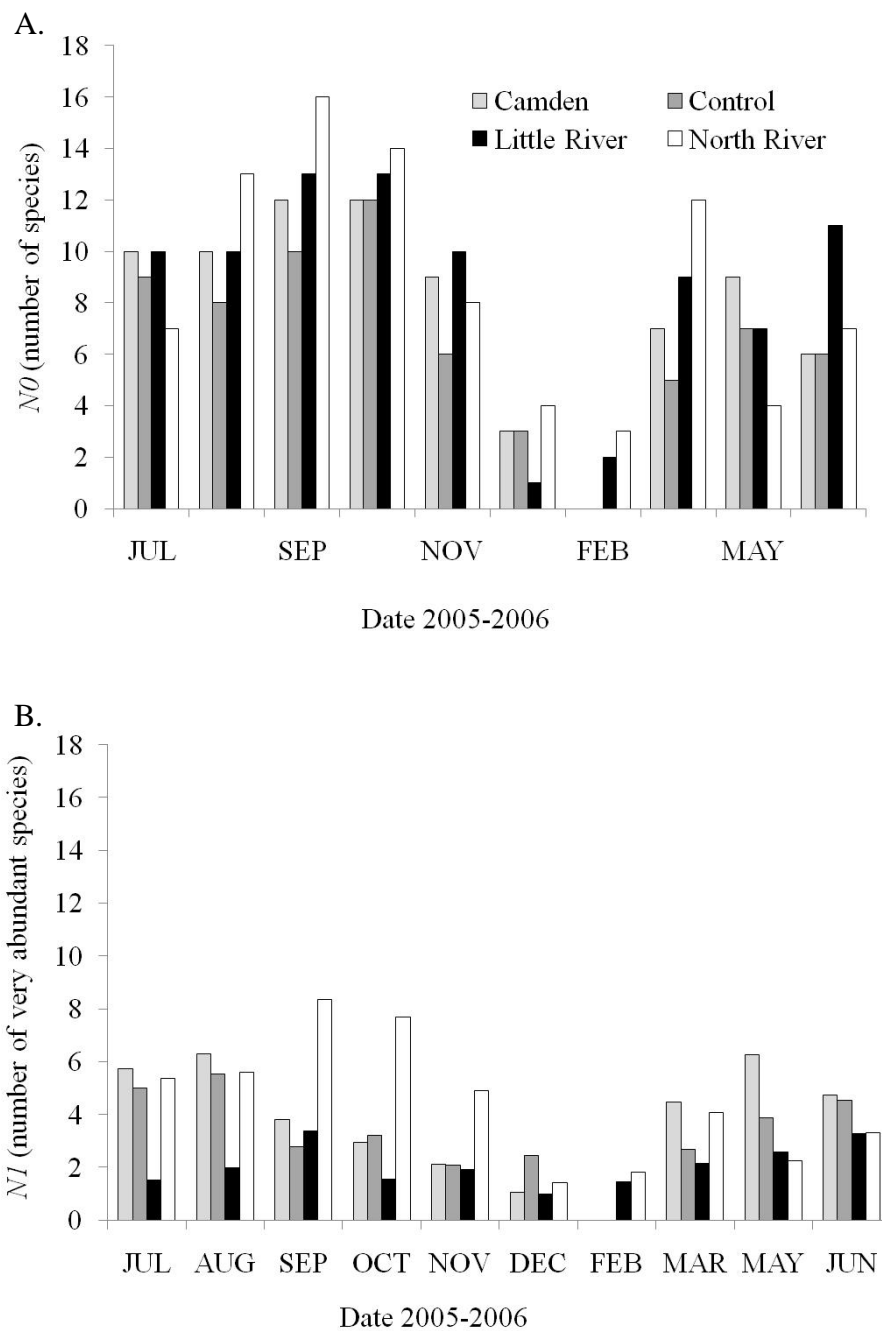

Figure 4-8. Hill's NO (A., number of species) and NI (B., number of very abundant species) of fish sampled over the sampling dates, 2005-2006. Camden=Camden Model Location.

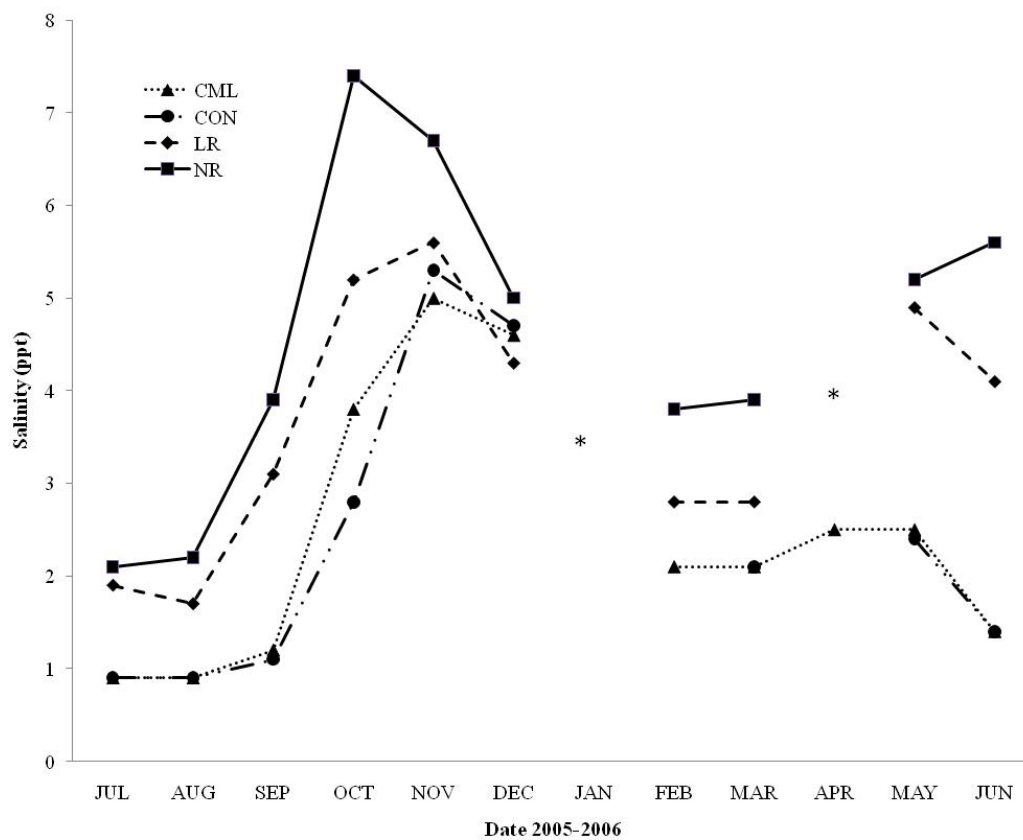

Figure 4-9. Average salinity (ppt) from YSI model 85 taken at the four different study locations from July 2005-June 2006. CML=Camden Model Location, CON=Control, LR=Little River, and NR=North River. Asterisks indicate missing data.

Table 4-1. Common and scientific names of macroplankton caught at all four sampling locations from July 2005-June 2006. CML=Camden Model Location, CON=Control, LR=Little River, and NR=North River locations. "+"= species present; "0"= species not present. *Mudcrab zoea and megalopa were counted as one taxa.

Common name	Scientific name	CML	CON	LR	NR
Grass shrimp	<i>Palaemonetes</i> sp.	+	+	+	+
Mudcrab zoea	<i>Rhithoropaneopeus harrisii</i> *	+	+	+	+
Mudcrab megalopa	<i>Rhithoropaneopeus harrisii</i> *	0	+	0	+
Calinoid copepod	Order Calanoida	0	0	+	+
Cyclopoid copepod	Order Cyclopoida	+	0	+	0
Medusa	Phylum Cnidaria	0	0	0	+
Mussel	Class Bivalvia	0	0	+	0
Clam	Class Bivalvia	0	0	+	0
Fish	<i>Anchoa</i> sp.; <i>Syngnathus</i> sp.; unknown	0	+	0	+
Amphapod	<i>Gammarus</i> sp.	+	+	+	+
Isopod	Order Isopoda	0	0	0	+
Arthropod-fish lice	<i>Argulus</i> sp.	0	+	+	+
Branchiopoda, Cladocera	<i>Leptodora</i> sp.	+	+	0	0
Fish eggs	Unidentified	+	0	+	+
Penaeid shrimp	<i>Litopenaeus</i> sp.	0	0	0	+
Mysid shrimp	<i>Mysidopsis</i> sp.	0	0	+	+
Polychaete and larvae	Class Polychaeta	+	+	+	0
	Number of taxa	7	7	11	11
	Number of unique taxa	0	0	2	3

Table 4-2. Common and scientific names of nekton caught at all four sampling locations from July 2005-June 2006. CML is the Camden Model Location, CON is the Control, LR is the Little River and NR is the North River locations. "+"= species present; "0"= species not present. Associations are indicated by B=brackish, F=fresh, M=marine, and D=diadromous.

Common name	Scientific name	Location				Association
		CML	CON	LR	NR	
Blue crab	<i>Callinectes sapidus</i>	+	+	+	+	B
Silver perch	<i>Bairdiella chrysoura</i>	+	+	+	+	B
Hogchoker	<i>Trinectes maculatus</i>	+	+	+	+	F-B
Spot	<i>Leiostomus xanthurus</i>	+	+	+	+	B
White perch	<i>Morone americana</i>	+	+	+	+	F-B
Atlantic croaker	<i>Micropogonias undulatus</i>	+	+	+	+	B-M
Striped bass	<i>Morone saxatilis</i>	+	+	+	+	D
Southern flounder	<i>Paralichthys lethostigma</i>	+	+	+	+	B
Striped mullet	<i>Mugil cephalus</i>	0	0	+	+	B-M
Atlantic menhaden	<i>Brevoortia tyrannus</i>	+	+	+	+	B-M
Gizzard shad	<i>Dorosoma cepedianum</i>	+	+	+	+	F-B
Atlantic needlefish	<i>Strongylura marina</i>	0	0	+	+	F-B
Longnose gar	<i>Lepisosteus osseus</i>	+	+	+	+	F-B
White catfish	<i>Ameiurus catus</i>	+	+	+	+	F-B
Ladyfish	<i>Elops saurus</i>	0	0	+	+	B
Yellow perch	<i>Perca flavescens</i>	0	+	0	0	F
Chain pickerel	<i>Esox niger</i>	0	+	0	0	F
Bay anchovy	<i>Anchoa mitchilli</i>	+	+	+	0	B
Spotted seatrout	<i>Cynoscion nebulosus</i>	0	0	0	+	B
Weakfish (grey trout)	<i>Cynoscion regalis</i>	0	0	+	+	B
Golden shiner	<i>Notemigonus crysoleucas</i>	+	0	0	0	F
Bowfin	<i>Amia calva</i>	0	+	0	+	F
Bluefish	<i>Pomatomus saltatrix</i>	0	0	+	+	B
Black drum	<i>Pogonias cromis</i>	0	+	+	0	B
Alewife	<i>Alosa pseudoharengus</i>	+	+	+	+	D
Brown shrimp	<i>Farfantepenaeus aztecus</i>	0	0	0	+	B
Hickory shad	<i>Alosa mediocris</i>	+	+	+	+	D
American shad	<i>Alosa sapidissima</i>	0	0	+	+	D
White bass	<i>Morone chrysops</i>	0	0	0	+	F
Common carp	<i>Cyprinus carpio</i>	0	+	0	0	F
Green sunfish	<i>Lepomis cyanellus</i>	+	0	0	0	F
Atlantic sturgeon	<i>Acipenser oxyrinchus oxyrinchus</i>	0	0	0	+	D
Red drum	<i>Sciaenops ocellatus</i>	0	0	0	+	B
Atlantic silverside	<i>Menidia menidia</i>	0	0	0	+	B
Pumpkinseed sunfish	<i>Lepomis gibbosus</i>	0	+	0	0	F
	Total individuals	719	898	2628	1109	
	Total species	17	21	22	27	
	Number of unique species	2	4	1	6	

Table 4-3. Statistical results comparing the salinity of the In-Plant sample just prior to discharge and the salinity of the receiving waters at the study locations determined by two-tailed Student's t-test; $\alpha=0.05$: Camden Model Location (CML), Control (CON), Little River (LR) and North River (NR). All values are Student's two-tailed p-value, $\alpha=0.05$. Asterisk indicates statistical significance.

Sites	In Plant	CON	LR	NR
CML	* <0.001	0.938	0.069	*0.007
CON	* <0.001		0.093	*0.012
LR	* <0.001			0.198
NR	* <0.001			

CHAPTER 5: CONCLUSIONS AND RECOMMENDATIONS

By

Katharine E. Kleber

Interdisciplinary Program in Biological Sciences

Department of Biology

East Carolina University, Greenville, NC 27858

Eastern North Carolina is addressing increasing populations demands with production of potable water using Reverse Osmosis Water Treatment Plants (RO-WTPs). A by-product of these RO-WTPs is concentrated brine discharged into local surface waters. Earlier "pre-construction studies" reported in the literature have focused on either the effects of the withdrawal of groundwater to the surrounding users, or a plume study to determine the rapidity of concentrate mixing into the ambient waters (R.M. Towill Corporation 1998; Wilson Okamoto and Associates, Inc. 1999). There are no previous, published investigations into the effects of this brine on resident and transient biota.

The main goal of this study was to gain information on the impact and interaction of briny concentrate discharge with the surrounding environment including resident and transient biota. Objectives included a) investigating the possible differences in the chemical characteristics of the receiving waters; b) assessing these possible differences to abundance and distribution of benthic macroinvertebrates in relationship to the discharge; c) assessing the effects of the discharge on the local macroplankton and nekton community; and d) assessing possible differences in community diversity between the existing RO-WTP as well as the two proposed locations.

Our approach was to investigate possible changes on the receiving waters and possible changes to the resident and transient biota by: 1) documenting current water conditions at an established RO-WTP, 2) documenting the ambient water quality and chemistry at one control location, and two locations of future RO-WTP discharge; and 3) documenting the biota inhabiting the study areas, establishing a baseline of species data. We conducted this study prior to construction of two RO-WTPs in the North Carolina counties of Pasquotank (Little River, LR) and Currituck (North River, NR). We also used the existing RO-WTP in Camden County as a model of a currently operating plant (Camden Model Location, CML), and established a Control location 0.5 km downstream (Figure 5-1). We collected data regarding the prevailing water chemistry and flow patterns at each location. We collected macroinvertebrates from set sites at and around the diffuser pipe at the CML (Figure 5-2) and at the other study locations. We also collected macroplankton and nekton from these same locations. Along with the monthly biotic sampling, we collected concurrent water chemistry parameters of temperature ($^{\circ}\text{C}$), temperature-corrected conductivity (μS), salinity (ppt), dissolved oxygen (mg/L), and percent saturation of oxygen (%) measured by a YSI model 85 handheld meter to get an instantaneous “snapshot” of the water chemistry. For time-series data, we further investigated water chemistry through placement of two Hydrolab sondes deployed at 1.2 m and 2.2 m at the CML from July to December 2005, and at the Little River and North River locations in April and May 2006. The sondes recorded temperature, dissolved oxygen, percent saturation, salinity, conductivity, chlorophyll *a* ($\mu\text{g/L}$), pH, and total dissolved solids (g/L). We downloaded data monthly then redeployed the sondes.

Using only the water chemistry data, differences were observed by location based on salinity. The CML and Control locations were statistically similar (two-tailed Student’s t-test, α

= 0.05; $p = 0.938$) to each other and to the Little River location ($p = 0.069$ and $p = 0.093$, respectively). However; the North River site was significantly different from the CML ($p = 0.007$) and Control locations ($p = 0.012$), but not significantly different in salinity and conductivity from the Little River location ($p = 0.198$) (Chapter 2).

Investigating the estuarine continuum based on the biota was our next step. We sampled monthly three faunal types: benthic macroinvertebrates, macroplankton and nekton. Collection effort of benthic macroinvertebrates was much higher at the CML but equal for the other locations; the collection effort of the other faunal types was equal. The differences in effort were noticeable when looking at the differences in number of species found overall, but these differences were primarily the presence of rare species. Calculation of Hill's H_1 diversity index (number of very abundant species) removed the weight on the rare species and illustrated the similarities in the macroinvertebrate communities at each location (Chapter 3). When we examined the individual faunal types, we observed significant differences by date for all three faunal types and moderately significant differences for the macroinvertebrates (Spearman's Rho = 0.107) and nekton (Spearman's Rho = 0.237) based on location (Chapter 3 and Chapter 4, respectively). Only two species of macroinvertebrates were present in sufficient numbers at all locations to use as indicators to determine the effects of the brine entering the system at the CML and then predict briny discharge effects at the future RO-WTP discharge locations. The briny discharge from the CML clearly had an effect on these two species, but we did not observe these effects beyond 5 m from the diffuser pipe (Chapter 3).

Investigating the estuarine continuum further, led us to several of the fundamental descriptive variables of ecology and conservation biology: the measures of alpha, beta, and gamma diversity. The definition of alpha diversity is the species richness within a naturally

delineated habitat patch, gamma diversity is the total species richness of a large geographic area, and beta diversity is as the change (turnover) of species composition over relatively small distance; adjacent, but recognizably different habitats (Brown and Lomolino 1998). Jost (2007) suggested that the traditional equation $\gamma = \beta * \alpha$ is not an accurate measure of these levels of diversity as they are interdependent. Jost (2007) also suggested the use of MacArthur's homogeneity measure, which indicates the proportion of the total diversity found in the average community and will equal unity when these samples are identical and $1/S$ (S represents the number of species found from all locations) when each community is unique.

Following the suggested modifications to each diversity variable (Jost 2007) led to the determination that the communities are similar for all faunal types studied. For macroinvertebrates, a beta diversity of 1.45 indicated that the communities were similar across the four study locations. This was supported by a MacArthur's homogeneity of 0.72. A beta diversity of 2.07 indicated that the macroplankton communities were somewhat dissimilar across the four study locations. This was supported by a MacArthur's homogeneity of 0.51. A beta diversity of 1.38 indicated that the nekton communities were similar across the four study locations. This was supported by a MacArthur's homogeneity of 0.75.

Overall, the communities sampled from the four locations were typical oligohaline to mesohaline estuarine biota. Each faunal type sampled showed seasonal changes in composition and numbers over the course of the one-year of study. Though there were significant differences between the CML-Control locations and the North River locations based on salinity, there was essentially no difference in faunal communities between locations based on salinity. The effects of the CML briny discharge on the two macroinvertebrate species investigated were not observed beyond 5 m from the diffuser pipe in all axial directions sampled.

Overall Conclusions

The main goal of this study was to gain information on the impact and interaction of briny concentrate discharge with the surrounding environment including resident and transient biota. Objectives included a) investigating the possible differences in the chemical characteristics of the receiving waters; b) assessing these possible differences to abundance and distribution of benthic macroinvertebrates in relationship to the discharge; c) assessing the effects of the discharge on the local macroplankton and nekton community; and d) assessing possible differences in community diversity between the existing RO-WTP as well as the two proposed locations.

- The physical and chemical conditions around the Camden Model Location (CML) and the two proposed discharge sites are comparable to similar habitats in this region of North Carolina.
- The water columns from all locations, except CML, were well mixed.
- Ion concentrations from the CML were higher and more variable at the bottom; samples taken from the surface were less variable and similar to ion concentrations taken from the Control location. Indicating that the discharge plume was concentrated primarily in the lower half of the water column.
- The observed differences between surface and bottom samples at the CML were not statistically significant.
- Ion ratios found in the In-Plant samples were similar to those found in normal seawater.
- It is unlikely that the addition of this briny discharge will have an affect the surface water classification based on ion ratios.

- There were low ambient levels of ammonium ($\text{NH}_4^+ - \text{N}$) and nitrate + nitrite ($\text{NO}_x - \text{N}$) at all study locations, except from the bottom samples at CML within 5 m of the diffuser pipe.
- Phosphorus ($\text{PO}_4^{3-} - \text{P}$) was below the level of detection at all locations except for the CML, diffuser bottom samples and In-Plant samples.
- The CML RO-WTP is introducing significant ($p < 0.001$) amounts of ammonium based on measurements of In-Plant samples.
- All water samples from all locations had $\text{Ca}^{2+}:\text{Na}^+$ ratios much less (average 1:20) than the 15:1 ratio found to cause high mortality rates in test organisms reported by other investigators.
- The proposed RO-WTP discharge locations are situated in high energy locations, Chapter 2, which will be important in the mixing of the briny concentrate into ambient waters.
- Sediments from all locations were primarily sand-sized and generally contained $< 2\%$ organic matter.
- Sediment composition did not change over the six-month period.
- The proposed locations of the RO-WTPs are comparable other the CML and the Control locations for distribution of faunal types and communities.
- Diversity between locations was similar for the three faunal types collected – benthic macroinvertebrates, macrozooplankton, and nekton.
- We saw reduced density of two benthic macroinvertebrate species near the diffuser pipe and an increase in their densities beyond a distance of 5 m from the diffuser pipe at the CML.

- The briny discharge is unlikely to create a thermal refuge during the hottest and coldest times of the year, because of the anoxic nature of groundwater and the rapidity of mixing with the ambient waters.
- No effects of briny discharge were observed for the abundance of macrozooplankton and nekton during the period of study.
- It is unknown if blue crabs (*Callinectes sapidus*) will be attracted to the new areas of discharge.
- Differences in distribution and abundance were related more to ocean influence at the North River site and not to effects of briny discharge.
 - We collected four unique species of benthic macroinvertebrates from the CML, and two unique species from the North River location.
 - We collected fish eggs from the CML, Little River, and North River locations indicating possible spawning habitat.
 - Larval fish were collected only from the Control and North River locations, indicating that these two locations may be nursery habitats.
 - We collected three unique species of macroplankton from the North River location, two from the Little River location and one from both the CML and Control locations.
 - We sampled six unique species of nekton from the North River location, and two each from the CML and Control locations.

Recommendations

- Continue data collection related to the discharge of brine into oligohaline and mesohaline estuarine waters.
- Create measurable indicators of biotic integrity for the oligohaline reaches of Albemarle Sound.
- Continue sampling of post-construction locations (Little River and North River) to investigate the plume effects on the benthic macroinvertebrates.
- Continue sampling of post-construction locations (Little River and North River) to investigate the effects of increased volume of brine on the macrozooplankton and resident and transient nekton.
- Combine surface water and groundwater regulations in North Carolina.

References

Brown, J.H., and M.V. Lomolino. 1998. *Biogeography*. Sinauer Associates, Inc, Sunderland, MA. 692 p.

Jost, L. 2007. Partitioning diversity into independent alpha and beta components. *Ecology* 88: 2427-2439.

R.M. Towill Corporation. 1998. Final environmental assessment Waialae west well, Waialae, Honolulu, Oahu, Hawaii. TMK: 3-3-14:16. R.M. Towill Corporation, Honolulu, Hawaii. 98 p.

Wilson Okamoto and Associates, Inc. 1999. Final environmental assessment and finding of no significant impact (FONSI) Haleiwa well II exploratory well site. Waialua, Oahu, Hawaii. Prepared by Wilson Okamoto and Associates, Engineers and Planners, Honolulu, Hawaii. 100 p.

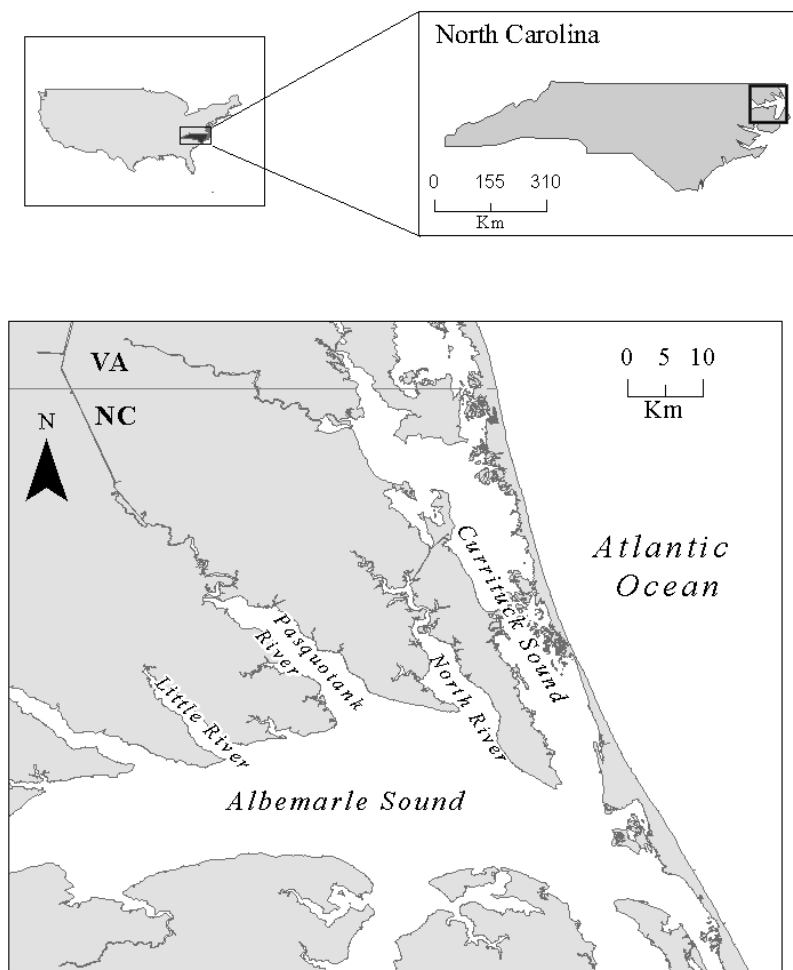

Figure 5-1. Map of study locations: Camden Model Location and Control location (Pasquotank River), the mouth of the Little River (Pasquotank County), and the mouth of the North River (Currituck County), which are the future sites for briny discharge.

