

Abstract

The Migration of the Sharpie: Environmental, Economic, and Archaeological Aspects

By: Lauren A. Rotsted

February, 2015

Director: Dr. Bradley Rodgers

Department of History

In the late nineteenth century, the United States saw the development of a crucial working vessel type, the sharpie. This thesis will demonstrate that as the sharpie migrated south down the east coast of the United States, its design and purpose evolved to fit the needs of each locale. The goal of this research is to investigate and analyze the economic and environmental factors that affected the evolution of the sharpie as it migrated down the east coast of the United States. Three areas in particular had an effect on the sharpie's design: Long Island Sound, Chesapeake Bay, and the Pamlico Sound. By examining the environmental and economic differences in these locales, reasons behind changes in structure, design, and usage of the sharpie can be ascertained. Research in sharpie evolution can be done through the use of the historic record, ships plans, and photographs. Though rare, there are some instances where the archaeological record can assist in the assessment of the changes in the sharpie vessel. Through this research it will be determined if the changes seen in sharpie design are a direct reflection of the environment and economy. Secondary to environment and economy were the cultural practices and boat building traditions of each locale, which exacted a strong influence on sharpie design and usage. In conclusion, the sharpie vessel was affected by many factors as it was adopted in different locales including environment, economy, culture, and tradition.

The Migration of the Sharpie
Economic, Environmental, and Archaeological Aspects

A Thesis

Presented to

The Faculty of the Department of History
Of East Carolina University

In Partial Fulfillment

Of the Requirements for the Degree
Masters of Arts in Maritime Studies

By

Lauren A Rotsted

February, 2015

© Lauren A Rotsted, 2015

The Migration of the Sharpie
Economic, Environmental, and Archaeological Aspects

By

Lauren Rotsted

APPROVED BY:

DIRECTOR OF THESIS: _____

BRADLEY RODGERS, PhD

COMMITTEE MEMBER: _____

LYNN HARRIS, PhD

COMMITTEE MEMBER: _____

DONALD PARKERSON, PhD

COMMITTEE MEMBER: _____

CHARLES EWEN, PhD

DEPARTMENT OF HISTORY CHAIR: _____

GERALD PROKOPOWICZ, PhD

DEAN OF GRADUATE SCHOOL: _____

PAUL GEMPERLINE, PhD

TABLE OF CONTENTS

LIST OF FIGURES.....	vi
CHAPTER 1: INTRODUCTION.....	1
Purpose of Research.....	1
Research Methodology.....	3
Previous Research.....	3
Conclusion.....	4
CHAPTER 2: NEW HAVEN.....	6
Environment.....	6
Economy.....	9
Transitional Forms.....	11
Log Canoes.....	11
New Haven Sharpie Form.....	15
Catalysts for Development.....	15
Characteristics.....	18
Archaeology and Ethnography.....	22
CHAPTER 3: CHESAPEAKE BAY.....	26
Environment.....	26
Economy.....	28
Transitional Forms.....	29
Chesapeake Bay Sharpies.....	29
Catalysts for Development.....	29
Characteristics.....	31
Sharpie/Beamy Sharpie.....	32
Hampton Flatties.....	35
Bateaux.....	36
Bugeye and Brogan.....	36
Skipjack.....	38
Terrapin Smack.....	41
Archaeology and Ethnography.....	42

CHAPTER 4: NORTH CAROLINA.....	43
Environment.....	43
Economy.....	44
Transitional Forms.....	45
North Carolina Sharpie.....	50
Catalysts in Development.....	50
Characteristics.....	51
Archaeology.....	56
CHAPTER 5: SURVIVAL DURING THE ERA OF STEAM AND INTERNAL COMBUSTION.....	58
CHAPTER 6: ALTERNATIVE SHARPIE FORMS.....	61
Great Lakes.....	61
Florida.....	70
CHAPTER 7: CONCLUSION.....	76
Environments.....	76
Economy.....	77
Transitional Forms.....	78
Sharpie Forms.....	78
Archaeology and Ethnography.....	82
Conclusion.....	82
BIBLIOGRAPHY.....	86
APPENDIX 1. TABLES OF SHARPIE DIMENSIONS.....	92
APPENDIX 2. ADDITIONAL PHOTOS.....	95

LIST OF FIGURES

1:	Bathymetric Map of Long Island Sound.....	6
2:	Photo of <i>Crassostrea virginica</i>	7
3:	Map of Distribution of <i>Crassostrea virginica</i>	8
4:	Carving by Theodore de Bry of Native Americans hollowing out canoes.....	12
5:	Drawing of Oyster Tongs.....	16
6:	Drawing of Connecticut Sharpie.....	17
7:	Photo of <i>Isabel</i> a sharpie off Savin rock, Connecticut.....	19
8:	Typical Leg o' mutton sails.....	20
9:	Photo of New Haven Oyster Tonging Sharpie.....	23
10:	Illustration of hand held oyster dredge.....	24
11:	Bathymetry map of Chesapeake Bay.....	27
12:	Bathymetric Map of Waterways feeding Chesapeake Bay.....	28
13:	Howard Chapelle's Modified sharpie design.....	32
14:	Yawl rigged yacht.....	33
15:	Maryland sharpie.....	34
16:	Design of Hampton Flattie based off Kunhardt's plans.....	35
17:	.Plan of Chapelle's Seaside Bateaux 13 ft, one sail.....	36
18:	The bugeye <i>JC Armiger</i>	38
19:	Skipjack model.....	40
20:	Plan of terrapin smack.....	42
21:	Bathymetric map of coastal NC.....	43
22:	Oyster tonging near Beaufort NC 1887.....	46
23:	Oyster boats in Beaufort 1887.....	46
24:	Sharpie <i>The Three Friends</i>	47
25:	Sharpie Schooner <i>Prince</i>	48
26:	Fishing on sharpie at Onslow Country Club 1930.....	49
27:	<i>The Julia Bel</i>	50
28:	Early oyster dredger.....	52

29:	Oyster dredging in Chesapeake Bay.....	53
30:	Sharpie schooner anchored near Beaufort 1905.....	54
31:	Plan view of Vessel 3.....	55
32:	Timeline of Sharpie and Steam.....	58
33:	Map of the Great Lakes.....	62
34:	Bathymetric Map of the Great Lakes.....	62
35:	Fishermen using a pound net on Lake Erie.....	64
36:	Parker’s Version of the small Ohio sharpie.....	66
37:	Gaff Rigged topsail pound net boat.....	68
38:	Table Comparing Average Measurements of Florida and Great Lakes Sharpies.....	69
39:	Bathymetric Map of the Florida Coast.....	70
40:	Bathymetric Map of the Gulf Stream.....	71
41:	Photo of the <i>Kingfish</i>	72
42:	Photo of the <i>Egret</i>	73
43:	Diagram of <i>Egret</i>	74
44A:	New Haven Sharpie Visual Comparison.....	80
44B:	Chesapeake Bay Skipjack Visual Comparison.....	80
44C:	Core Sound Sharpie, Bessie D, Visual Comparison.....	81
45:	Cycle of Economics, Ecology, and Technology.....	82
46:	New Haven Cycle of Economics, Ecology, and Technology.....	84

Chapter 1

Introduction

Purpose of Research

The purpose of this thesis project is to investigate and analyze the economic and environmental factors that affected the evolution of the sharpie schooner as it migrated down the east coast of the United States. In particular, this research identifies and analyzes how the economies and environments of three different locales affected changes in the design and use of the sharpie. The locales are Connecticut, Chesapeake Bay, and North Carolina. In order to have a controlled test group, only sharpies built and used in these areas from 1870-1915 will be compared. As one of the most highly used but least formally recorded workboats from this time period, this research tracks the migration of the vessel class and examines how the different localities affected changes to the workboat's construction, design, and usage. The sharpie is one of the few vessels that managed to remain significant through sail to the transition to the internal combustion engine power. The sharpie allows a rare and academically intriguing look into a sailing craft that saw usage during both the sailing and the power era. Through this research, the characteristics that enabled the sharpie to continue to be a viable workboat well into the powerboat era will be identified and analyzed through historic, literary, ethnographic, and archaeological sources.

Used widely as a shell-fishing vessel, this boat was popular during the end of the 19th century and into the 20th century. These vessels were commonly used as oyster dredges and other near and in-shore work because of their shallow draft and steadiness (Rodgers 2000:30).

Thought to have originated in New Haven, Connecticut in the 1840's, the sharpie was originally designed for the oyster fishery. Described as a refined flat bottom skiff, the unique sharpie design was adaptable and useful. The earliest sharpies were long, narrow, open skiffs with a centerboard and a square stern. Its name was the least affected trait of this vessel as it evolved and migrated north to south. But many of the unique qualities of the sharpie design, despite local changes, allow its migration to be traced from economic zones in the northeast of the United States southward (Chapelle 1951:101).

This thesis research will strive not only to identify the changes and the progression of the sharpie, but also analyze why so many different environments found this workboat type useful. This research will investigate how the economics and environments of these three regions affected the construction and use of the sharpie.

By the 1870's, the sharpie appeared in the Chesapeake Bay area. Although it retained its name, it did not keep all of the characteristics of the original version. Instead the design changed and was tailored to meet the needs of the local oyster fisheries. The Chesapeake Bay version was characterized by a V-shaped hull in cross section and a daggerboard replaced the centerboard.

Later in the 1870's, the coast of Eastern North Carolina became populated with sharpies as the oyster industry exploded. The North Carolinian sharpies re-adopted many of the New Haven sharpie characteristics but looked drastically different from the Chesapeake Bay type (Parker 2007:12).

Research Methodology

Sharpies were common in the late 19th and early 20th centuries, in part, because of their usefulness, their inexpensive construction, and low operation costs. However, many of these boats were not recorded formally in national census, such as the *Annual List of Merchant Vessels in the United States*, because many of them were locally and privately built and intended for work use in local waters. Since there is very little written information concerning sharpies, the scant archival information will have to be supplemented by the archaeological record. All possible information concerning sharpies will be compiled using scholarly works, ships drawings, historical records, oral histories, and recorded archaeological evidence.

The archaeological record will allow historical information to be supported or refuted through physical evidence. It is hoped that the analysis of the few known archaeological findings will provide details to this research that the historical record alone could not.

Previous Research

The scarcity of information concerning sharpie vessel types prevents the subject from being widely researched. However, there are a few very notable works that are essential to this research and any research involving sharpie boat types. Howard I. Chapelle has written multiple pieces on sharpies and other American ship types from this time period including, *The Migrations of an American Boat Type*. Publications by Rusty Fleetwood, such as *Tidecraft*, have been invaluable to those studying 20th century American ship types. The Chesapeake Bay Maritime Museum in Maryland has an exhibit of 20th century workboat and oyster fishing craft,

which is published in full in the book, *Heritage in Wood: The Chesapeake Bay Maritime Museum Small Boat Collection*. The foremost book in sharpie research is the *Sharpie Book* by Reuel Parker, written using the collection at the Chesapeake Bay Maritime Museum. The North Carolina Maritime Museum in Beaufort, North Carolina possesses an extensive collection of photographs and models.

Along with these publications, the available archaeological evidence concerning sharpies will be used. Prominently, Vessel #3 at Castle Island, which was discovered and mapped by ECU field school students under the direction of Dr. Bradley Rodgers and Dr. Nathan Richards in 1990, has become a major source for archaeological evidence of sharpie workboat types. The Vessel #3 at Castle Island is the only sharpie from this time period that has been examined in situ (Richards 2001:30). The display of small boats at the Beaufort Maritime Museum in North Carolina has an extensive exhibit on the sharpie vessel type and other small American craft from the 20th century. The Mariner's Museum of North Carolina has a collection of sharpies and models. In some areas, people still build these vessels today, giving living ethnographic examples of the sharpie's modern counterpart.

Conclusion

In summary, this project strives to not only track the physical changes to the sharpie as it migrated to each of the aforementioned locales but to also analyze the economic reasons behind the changes using an "economic Darwinist" approach pioneered by Milton Friedman (Friedman 1953:3-43). Though previous works have identified the migration of the sharpie and its many changes in different locales, little research and analysis has been done into the catalysts behind these changes. The significance of this research lies in the deeper investigation of the facilitators

of change in the sharpie. By examining the environment and economics separately and together, it can be demonstrated what combination of conditions led to the specific designs for each locale. The sharpie vessel was an icon amongst these three communities, providing transportation and a means of survival for multiple generations of Americans. In order to fully appreciate and understand the importance of the sharpie vessel, the research must encompass not just the physical changes, but the economic, environmental, and cultural reasons driving its physical change. The sharpie's migration and evolution allows insight into not just an important American vessel, but also into the lives, cultures, and environments of those who built and used them. This work will strive to draw the previously unexplored connection between economics and the changes in sharpie design. By using previous studies and works, this research will facilitate an understanding of how different economies influenced the migration and the physical changes of the sharpie.

Chapter 2

New Haven, Connecticut

Environment

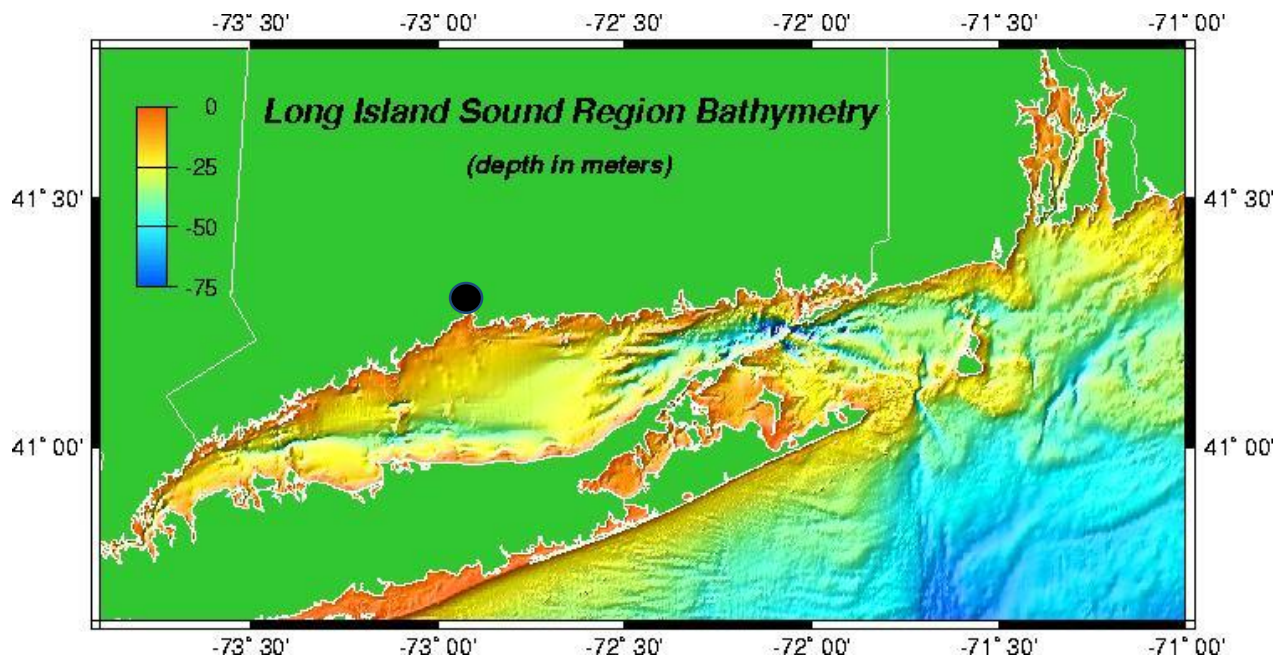

FIGURE 1. Bathymetric map of Long Island Sound, circle represents New Haven area (USGS 2013)

The Long Island Sound is a protected stretch of coastal water that reaches from upper Connecticut south into New York State. Long Island itself serves as a barrier island to create the protected area of Long Island Sound. The sound is shallow and calm in comparison to the open ocean (See Figure 1). As can be seen from the bathymetry map of the Long Island Sound, the confined area is much shallower than the surrounding open ocean. Much of the sound is no deeper than 25 meters and many of the inlets less than 10 meters.

The bottom of the sound is a harder substrate, not loose sand or mud. The combination of the protected waters and a hard substrate, which the oyster needs to attach to, resulted in the perfect habitat for oysters. Oysters catalyzed an entire industry and shipbuilding practice. A complete sphere of commerce along the east coast of the United States revolved around oysters. To fully understand the industry and the boats therein, it is imperative to understand oysters and their environment.



FIGURE 2. Photo of *Crassostrea virginica* (Puglisi 2008:1)

The Eastern oyster occurs naturally in the Atlantic Ocean reaching from its northernmost habitat in the Gulf of St. Lawrence to its southernmost point in the Gulf of Mexico and can be found as far south as Brazil (Puglisi 2008:3). The American oyster, *Crassostrea virginica* (See Figure 2), is a bottom dwelling filter feeding shellfish that has not only supplied the American east coast with food for centuries but inadvertently propelled the development of the sharpie boat form.



FIGURE 3. Map of distribution of *Crassostrea virginica* (McDonnell 2013)

Crassostrea virginica is a particularly tolerant species of shellfish, but certain areas like the Long Island sound, Chesapeake Bay, Outerbanks, and the Gulf of Mexico provide the ideal environment for oysters to thrive (See Figure 3). As filter feeders, oysters require a steady flow of water through their gills in order to extract nutrients suspended in the water. Oysters flourish particularly well in areas that are dominated by estuaries, small tidal mouths where oceanic salt water and river fresh water can mix together to create brackish water. The chemical components of brackish water and the influx of both ocean nutrients and river nutrients create a particular environment that the oysters prefer (Getchiss et al. 2006:2).

Oysters form reefs both intertidally and subtidally so that the oyster colony is submerged most of or all of the time. An important component of the estuary and tidal region ecosystem, the oyster reefs not only act as water purifiers, but also provide a habitat for many fish and invertebrate species. The species has a unique tolerance for a fairly large fluctuation in salinity in

their environments, one of the reasons they proliferate in estuaries which have constantly changing salinity according to the influx of salt and fresh water (Ma et al. 2006: 481).

The popularity of oysters and the growth of the oyster market necessitated a specific type of watercraft for harvesting shellfish. As mentioned above, oysters are found in relatively shallow, brackish environments. Estuaries and sounds are unique because they are protected from the open ocean but are still affected enough to necessitate a sturdy ship. Conversely, these areas are also much too shallow to employ an oceanic style, full-bodied vessel. Flat bottom boats, on the other hand, provide the most stability but had poor sea faring qualities. Therefore, fisherman needed a boat that combined the size and power of an ocean-going ship and the versatility and draft of a flat bottom skiff. These unique conditions and expansion of the oyster industry would serve to combine to form the highly unique sharpie boat type.

Economy

Prior to European settlement, the Native American population subsisted off of the land with a combination of fishing, farming, and hunting. The Native population was a partially agricultural society but equally dependent on the other ecological spheres as opposed to the agriculturally dominated European society. The Native Americans farming techniques of rotation and migration kept the delicate ecosystem in balance. Concurrently, the local Native American population was not large enough to tax the natural ecosystem unduly. The arrival of European colonists and their sedentary and agriculturally based culture had a grave effect on the ecosystem and, in turn, the economy.

By the 1820's, only 25% of Connecticut's natural forest remained. This was a result of European farming, construction, and timber harvesting. By the 1830's, the land was exhausted of

nutrients and no longer usable for crops. Once the land had been exhausted, settlers were forced to turn to occupations other than farming, leaving the land to partially recover. The first species to reappear in the decimated forests was the white pine. As the white pine grew, it provided the needed shade and shelter for other slower growing hardwoods to grow (Smith 2004:2). In the late 19th century, the ever-determined settlers soon turned to the huge population of white pine as a source of revenue and materials. Saw mills sprang up along Connecticut's many inland waterways and the harvest and processing of white pine became a major industry in the state. By the early 1900's, the sawmill industry took a downturn as waterways became polluted and white pine was overharvested (Glaser 2014:3).

In a period of 150 years, the economic state and base fluctuated rapidly in the Connecticut area. With the arrival of the settlers, the economy was dominantly dependent on agriculture and food production. As the soil became depleted in the mid 1800's, the colonists turned to a combination of the harvesting of raw materials and the beginnings of industry to keep the economy alive. Misuse and lack of management led to yet another shift in the early 1900's to a dominantly industrial economy.

The economy and the environment of an area are inextricably and intimately entwined, each sphere affecting the other. Therefore when examining the economic or the environmental catalysts behind cultural trends, one must consider them both as separate entities and as a combined causation factor. This reciprocal relationship is particularly evident in the history and design of the sharpie vessel type. To understand how this vessel came to populate the waters of the east coast of the United States and what it reflects about its respective cultures, one must understand the driving factors and players in its creation and design. Therefore, this research will

focus on the combination of the local economies and the local ecosystems and how they combine to create a formula that results in the sharpie vessel.

Transitional Forms

Log Canoes

The sharpie is a culmination of a long evolution of small boat types. The earliest of these predecessors is the North American log canoe (Fleetwood 1995:4). When early European settlers arrived they found the dugout log canoe in extensive use by the Native Americans in both North and South America. Though the styles of log canoes varied widely amongst its users, they were all based on the same basic design. For the purpose of this study, the canoes focused on will be those constructed in the eastern United States.

In the eastern United States, dugout canoes were generally constructed from a single log of chestnut or pine. The canoe was formed by hollowing out the one log with a combination of fire and scraping (Volmar 2006:6). The resulting boat is narrow, fast, and shallow drafted but unstable. Dugout canoes were propelled by paddles or by poling (Fleetwood 1995:4). Some dugout canoes possessed a flat bottom to decrease the draft even more, but the majority of the canoes bore a clear semi-circle cross section. The size of the canoes varied greatly. Some were designed to carry only one or two passengers while others were large enough to seat thirty or forty people (Volmar 2006:4).

Native Americans used these boats for different purposes depending on their environment. Some groups, such as the Arawaks in the Caribbean, used log canoes for open water travel. Other groups, such as those near the Great Lakes, used them for river and estuarine travel (Fleetwood 1995:4). The dugout canoe was used for fishing, oystering, and transporting

goods and people. The dugout canoe served as an all-purpose craft for hundreds of years prior to European arrival. Though the basic principles of the dugout canoe are fairly pervasive, different groups adapted different styles and designs to fit their cultural and environmental needs.

The majority of historical evidence for log canoes is obtained from the writings of early European settlers, such as William Wood, and are supplemented by the woodcuts made by Theodor De Bry in the early 16th century (See Figure 4). Later in the 16th century an artist, John White, did extensive watercolor paintings of the log canoes and their uses.



FIGURE 4. Carving by Theodore De Bry of Native Americans hollowing out canoe. (Retrieved from (Volmar 2006:2))

The archaeological evidence of pre-Colombian canoes from is more scant than the historical evidence. However, there are a few good examples of well-preserved log canoes in the archaeological record. The Northeastern tradition is represented in examples found in Bethel, CT; Weymouth, MA; and Project Mishoon in CT (Volmar 2006:5). There is a particular presence of canoes both archaeologically and historically documented in four major areas:

Northeastern bays, Chesapeake Bay, shores and lakes of eastern North Carolina, such as Lake Phelps, and the east coast of Florida. The prevalence of the use of dugout canoes in these areas is likely due to the similar environments and topographies of the aforementioned areas. These areas were all highly dependent on the coastal and inshore waterways for travel and food, therefore, all the areas were in need of a small, shallow draft, efficient watercraft (Fleetwood 1995:6).

The Chesapeake Bay and the shores of Eastern North Carolina developed particularly advanced dugout canoe designs that stayed in use long after the arrival of the Europeans and the proliferation of horses in North America. The Chesapeake Bay dugout canoe developed into what is referred to as a platform bow canoe. The flattening of the bow helped to break the waves and handle the more aggressive conditions of the Chesapeake Bay more effectively than the unaltered canoe (Mariners Museum 2011). The log canoes built in the Chesapeake Bay area were traditionally made of loblolly pine or tulip poplar logs. The size of the canoe was directly related to the size of the log, ranging anywhere from a one person craft up to 30 feet long (Fleetwood 1995:5).

The canoe was used on the coast of North Carolina because of the multitude of shallow waterways and swamps that intersect along the coast. Before horses, canoes were the main method of transportation of people and goods in the United States. Canoes provided Native Americans with the ability to move the rich natural resources of the shallow estuaries and swamplands. The canoes of North Carolina were similar to their northern counterparts in construction technique and design. They were quick and agile, but unstable. With a typical length to beam ratio of 8:1, maintaining balance, particularly under load, was a challenge for the inexperienced user (Stick 1983).

The log canoe was a much more viable craft compared to early European vessels. Native Americans were slow to transition from the log canoe to more Europeanized watercraft. The canoe was large enough to handle trade and transportation but drew very little water, making the shallowest areas of the coastline accessible. Additionally, the agile and quick canoe was a much more practical choice in the coastal environment than the bulkier European craft.

Europeans quickly realized the merits of the log canoe and eagerly adopted the design (Stick 1983). European settlers combined their watercraft traditions with the Native American log canoe producing what was essentially a flat bottom canoe with increased stability (Parker 2007:2).

Flat Iron Skiff

For many years the log canoe remained a staple in the eastern United States, particularly in the New England fishing community. As the country's population and wealth expanded, so did the demand for products. Already an important staple in the industry of the East Coast, oyster fisheries in the north saw a boom in the early 1800's. In 1823, the oyster business began to boom in New England after a cache of oysters from the Chesapeake Bay was transplanted to the Long Island Sound. The oyster population thrived in the cold, brackish water of New England and industry expansion began (Parker 2007:2). The new industry propelled the need for a fleet of small watercraft in which oyster tonging, the process of collecting oysters, could take place. In addition to the increased need for small watercraft, the availability of large, whole trees to construct log canoes was becoming rare due to the increase in ship production by major companies based in New England. Saw mills were becoming pervasive throughout the country. With the lack of the availability of whole logs and the ready availability of cut timber, it was

clear that the local shipbuilding community would gravitate towards small craft constructed from cut timber.

The combination of these three factors led to the development of the flat iron skiff. The flat iron skiff, so named because of their resemblance to a clothing iron, was a crude workboat with a flat bottom used for oyster tonging. Its design relied heavily on aspects of the log canoe, emulating it as much as possible through the use of cut timbers (Parker 2007:3). These skiffs resembled the later sharpies in appearance, with the biggest difference being the flat iron skiffs' small size. The early skiffs had a square, rounded, or arced transom and were cheap to build and utilitarian in their use in shallow protected water (Sucher 1973:34). However, the early skiffs proved not hardy enough for oystering, and the design was quickly replaced by the sharpie. The first sharpie and its designer are not known, with multiple claims of the originator being made. However, it is known that the sharpie originated in the New Haven area of Connecticut close to the burgeoning oyster industry in the Northeast. By the 1840's the earliest version of sharpies began to dot the horizon of the Long Island Sound (Parker 2007:6).

New Haven Sharpie Form

Catalysts for Development

Oyster tonging was a specialized and demanding process that required a specific type of vessel to handle the everyday strain of the work. The development and use of the sharpie vessel was largely dependent on the use of this method for oyster harvesting. The oyster men would stand on the side of the boat to dip the long, heavy tongs into the water (See Figure 5). Then, in a scissoring motion, would use the raked ends of the tongs to scrape a pile section of oysters off the substrate. Similar to the concept of very large salad tongs, the oysterman would then haul the oysters back on board to be sorted in the boat. The oysters were then separated and measured,

with the smallest ones being thrown back (Mariners Museum 2002). Oyster tonging was heavy, back breaking, and slow work. This demanding task necessitated a highly specialized vessel that could handle the rigors of such a practice.

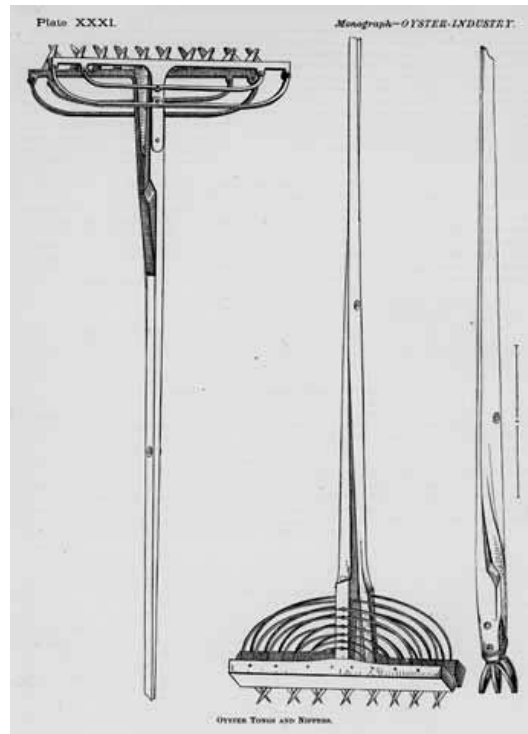

FIGURE 5. Oyster Tongs. (Courtesy of the Library at the Mariners Museum: *The History and Present Condition of the Fishery Industries, The Oyster Industry* 1881)

The sharpie vessel was used with log canoes and skiffs in the early 19th century, and there was little distinction made between sharpies and skiffs (See Figure 6). Often, any flat bottom boat over 20 feet was referred to as a sharpie, but over time the sharpie became a distinct and recognizable vessel type (Sucher 1973:324).

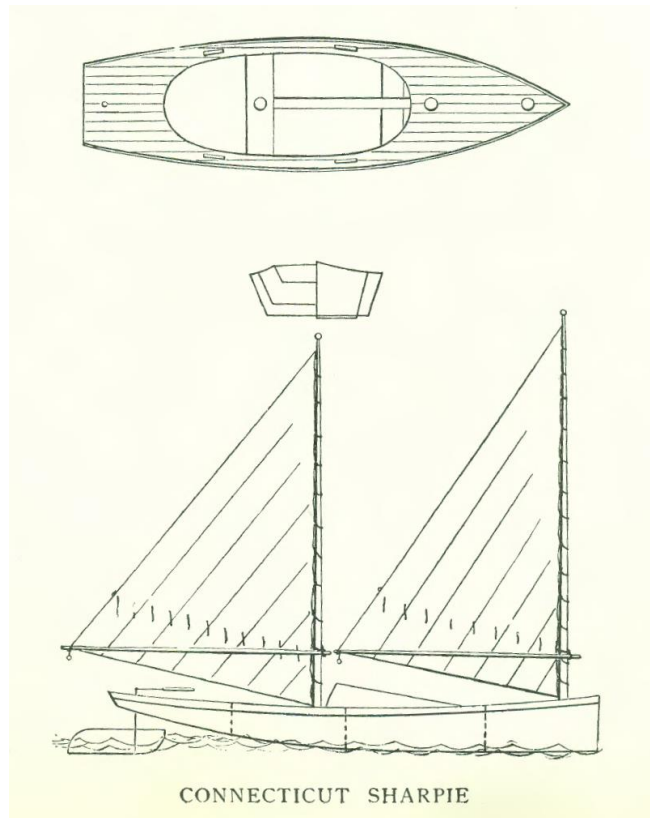

FIGURE 6: Drawing of Connecticut sharpie (Kunhardt 1889: 208)

The development of the sharpie vessel type was catalyzed by five main sources, both environmentally and economically based:

1. The depletion of near shore oyster beds from over harvesting (Environmental and Economical)
2. Lack of large hardwood to construct log canoes from farming (Environmental and Economical)
3. The naturally shallow coastal environment (Environmental)
4. The increase in the number of saw mills and the increased availability of lumber (Economy)
5. The decline of agriculture along the Long Island Sound (Economy)

The depletion of the near shore oyster beds meant that the oystermen had to travel farther out into the sounds or ocean to harvest oysters (Chapelle 1951:101). The necessity to expand into deeper waters was one of the factors that pushed the replacement of log canoes and skiffs by the more seaworthy sharpies. In addition, the prevalence of farming had already destroyed the large hardwoods needed to construct log canoes (Parker 2007:2). The natural coastal environment dominated by shallow waters and extensive inlets necessitated a specific vessel design by fabricating the vessel of smaller, cheaply produced parts (Parker 2007:4). With the expansion and multitude of sawmills in the area, cut lumber became readily available for this purpose. As farming took a downturn in profitability, people began to turn to other sources of revenue (Smith 2014:2). All of these factors combined to set the stage for the development of a specific type of watercraft that was cheap and easy to construct, large enough to sail to deeper oyster beds but with a shallow enough draft to traverse the waterways, and the capacity to carry enough product to make a living (Parker 2007:8). Soon after the appearance of the earliest, vaguest versions of sharpies, their usefulness and economical design made them rapidly popular. The adaptability of the vessel type is visible early on as different locales began to adopt and make specific changes to the sharpie to suit their needs and environments.

Characteristics

By 1850, the sharpie had taken on a set of specific characteristics in the locale of New Haven, Connecticut (See Figure 7). These sharpies became known as the New Haven Sharpie type. The New Haven sharpies were predominantly constructed, in the beginning, by two local builders: Graves and Rowe (Kunhardt 1889:212).



FIGURE 7. Photo of *Isabel*, a sharpie off Savin Rock, Connecticut, mid 19th century (NHYT, 2009)

The New Haven sharpie was altered to suit the specific needs of the booming oyster industry in the Long Island Sound. The earliest versions were 25-27 feet long, had a short fore and aft deck, and a long centerboard. The curve of the bottom of the sharpie was similar to the skiff, except it was larger in order to provide proportionally more displacement and load carrying capacity (Sucher 1973:30). The early sharpies were usually rigged with leg o' mutton sails (Chapelle 1951:104) (See Figure 8).



FIGURE 8. Typical Leg o' mutton sails at St. Michael's Regatta 1928 (Mystic Seaport 2014, Original image Rosenfield and Sons 1928) (Image 1984187.1984F)

The New Haven sharpie quickly became produced in two different standardized sizes (Parker 2007:6). The “one man” New Haven sharpie was designed to be operated by one fisherman. This sharpie version was 26-28 feet long and could carry 75 to 100 bushels of oysters at a time. Because of its load capacity, these were commonly referred to as “100 Bushel Boats” (Sucher 1973:323). The smaller type generally employed just one mast and one sail. As the oyster industry grew and the demand for oysters increased, these smaller sharpies were replaced by larger vessels in order to carry more oysters and therefore turn a larger profit.

The “two man” New Haven sharpie was designed to be worked by two or more fishermen. This version was 35-36 feet in length and could carry 150-175 bushels of oysters (Parker 2007:4-5). The majority of the New Haven sharpies were closer to this size because of the increased amount of product a larger vessel could carry. Kunhardt agrees with the general length proposed by Parker, but adds that the general breadth was about 6 feet at the base of the

hull. The depth amidships equals about 24 inches and the depth at the stem equaling about 36 inches.

By the 1880's the New Haven sharpies had increased in size with hulls between 35-40 feet. The majority were double-masted with a beam to length ratio of 4.5:1 (Sucher 1973:322). These measurements indicate an incredibly long, narrow boat with very little draft. The stem of the typical New Haven sharpie was made of oak and up to 15 inches wide at the lower end. The typical stem of a sharpie was thinner at the bottom to give flare (Parker 2007:5). The sections at the forward end were narrow to cut down on the inevitable pounding of a flat bottom boat. The stern could be square or round though many had round sterns in order to make tonging easier. A round stern offered the advantage of being less prone to foul sheets and lines, but was more expensive and time consuming to build than the square stern (Sucher 1973:321). If the stern was square, the rake was not less than 45 degrees and if the stern was round, it was nearly plumb. Both the larger and smaller sharpies shared the same broad design plan. The New Haven sharpie was half decked with washboards. To enable the sharpie to be heavily loaded but not have stem or stern submerge, the sharpie had high tucked stern and the deepest part of the hull was abaft midship (Parker 2007:5). The New Haven sharpie typically had no skeg, which was the aft end of the keel; more specifically, it was the piece that supports the heel of the rudder (Desmond 1998:209). The New Haven sharpie also possessed a long balanced rudder, with a design defined by equal amounts of blade fore and aft of the shaft (Mott 1997:45). The combination of these two design details led to a workboat that was easily maneuverable by one man. The sharpie had a heavy keelson, usually of at least three planks, which are set to form a girder. The reinforced keelson helped to keep the shape of the hull when sailing hard and prevented wringing. The sharpie necessitated a heavy bulkhead near the maststep to support the rig. The maststep was put

far forward so that the rig could revolve freely, since oystermen would usually let the sail fly free when over oyster beds. This sort of rig required extra support, hence the supporting bulkhead near the maststep (Sucher 1973:328).

One of the most important aspects of this vessel type was the inclusion of a movable centerboard. The adjustable centerboard allowed for control and balance in deep rough water, but it could also be drawn up in order to go into extremely shallow water and even be safely beached. The centerboard needed to be comparatively long and come above the rail on retraction to get the needed surface area for effective control. The aft end of the vessel was decked for 3 or 4 feet and the intervening space has a washboard 7-9 inches wide.

Archaeology and Ethnography

Sharpie vessels present an odd challenge in the historical record because their use began in the mid-19th century and continued well into the 20th century. This makes their existence a recent phenomena in comparison to the timelines usually examined in archaeology. Because of its relative modernity, most of our evidence comes from the writings and observation of those who actually built, designed, and employed the sharpie vessel. There is very little physical evidence in the archaeological record to enlighten researchers concerning these vessels.

However, this vessel is modern enough that there are still floating examples preserved in the United States. At present, for the Long Island Sound type, there are no archeological investigations at this current date that can provide us with direct physical evidence in the way of excavation. However, a researcher can still employ the premises of a good archaeological investigation while using the floating ethnographic examples as opposed to the usual buried examples. The Mystic Seaport Museum in Connecticut preserves and holds one of the largest

collections of floating artifacts and ships in the country. At the harbor rests the *New Haven Oyster TONGING Sharpie* built by Lester Rowe in 1890. The vessel came to rest at the museum in 1947 and has been preserved for future generations. This vessel offers a prime opportunity to study a sharpie first hand. The Oyster TONGING sharpie is 35 feet 4 inches in length and 6 feet 11 inches in beam and is considered a two-man sharpie. It exemplifies the qualities of a traditional New Haven sharpie including shallow draft, flat bottom, and a balanced rudder. This version also exemplifies the later style of the two-masted rig and a round stern. The centerboard, a key part of the sharpie's design, was a piece of movable oiler iron that was able to be moved up and down to allow variable immersion of the centerboard (Mystic Seaport 2014). The ability to move the centerboard was crucial to accommodate the changing depths of the sound. This vessel not only allows the researcher to understand the design in a way that only three dimension can offer but also allows a comparison to the historical record (See Figure 9). Mystic Seaport also contains ships plans and blueprints for a number of different sharpie designs.



FIGURE 9. Photo of the New Haven Oyster TONGING Sharpie at Mystic Seaport, CT, a living archaeological example (Mystic 2014)

Though the written records and ships plans from which these measurements were obtained are invaluable to the study of New Haven sharpies, another aspect of research provides a different look into the world of sharpies. In 1967, an oral interview was conducted with John Thomas. Mr. Thomas, born in 1881, was a lifetime resident of New Haven Connecticut. His father also owned one of the earliest and most prominent oyster houses in the state. He provides details of the oyster industry and sharpies that cannot be retrieved from ships plans and records. Thomas recounts how in the early days, sharpies were used predominantly on the natural oyster beds, which tended to be in shallower areas than the artificial beds. He also mentions that these sharpies were generally equipped with a 20 pound hand dredge (See Figure 10). These hand dredges were nothing more than metal-scraping mouths to separate the oysters from the substrate with containers attached to hold the oysters (FAD 2014).

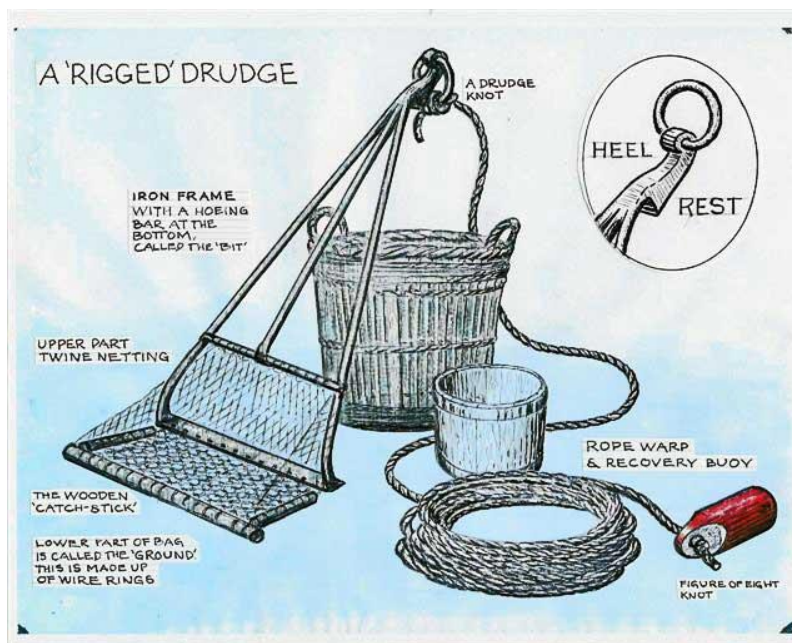

FIGURE 10. Illustration of a hand held oyster dredge, also referred to as a drudge (Harman 2014)

He mentions local builders of sharpies including George Graves, Riley Smith, William Barnes, and Henry Glen. Furthermore, he states that Riley Smith was known for building two masted sharpies. William Barnes built the 50-foot flat bottom sharpie called Effie May (Thomas 1967). Oral history is particularly valuable when there is very little archaeological evidence available, as in the case of New Haven sharpies.

Chapter 3

Chesapeake Bay

Environment

Chesapeake Bay is a protected portion of the Atlantic Ocean that reaches from southern of Delaware into Virginia. The Chesapeake Bay is sheltered from the harshness of the open ocean by the Delaware Peninsula and part of the body of Virginia. The James, Susquehanna, Potomac, York, and Rappahannock rivers are the main fresh water sources to the Chesapeake Bay. The influx of fresh water from these rivers combined with the ocean, much like the Long Island Sound, creates a brackish environment. The Chesapeake Bay has relatively high elevation compared to the open ocean but is not as shallow as the Long Island Sound (See Figure 11).

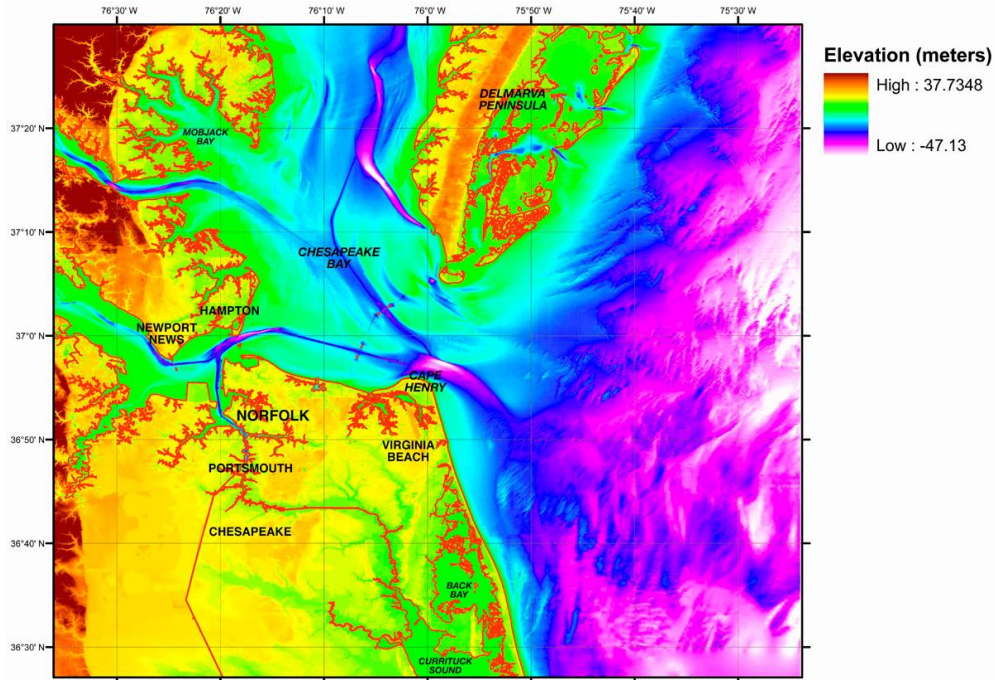

FIGURE 11. Bathymetry Map of Chesapeake Bay (NOAA 2007)

The Chesapeake Bay, like the Long Island Sound, is largely protected from the worst conditions of the open ocean, and the combination of fresh and salt water and relatively shallow depths along the shore create a healthy environment for the growth and propagation of oysters. The presence of oysters and the demand for a vessel that could be tailored to fit the unique needs of oyster fishermen led to the use of the sharpie early in the 1870's (Parker 2007:11). As can be seen from the bathymetric maps, the smaller waterways connected to the bay are shallow and pervasive throughout the coast (See Figure 12). The biggest difference between the Long Island Sound and the Chesapeake Bay was the distance to market. The Chesapeake Bay oystermen had a much longer journey to get to market than those in the Long Island Sound (Chapelle 1951:308). Though this may seem like a small detail, this changed the design of the sharpie in the Chesapeake Bay and led to a whole new set of vessel types.

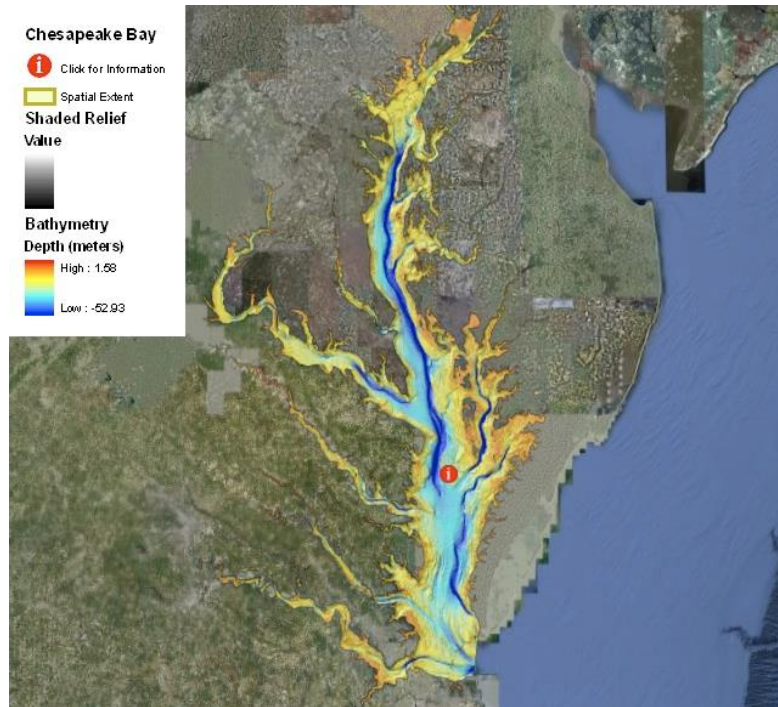

FIGURE 12. Bathymetric Map of Waterways feeding into the Chesapeake Bay (NOAA 2009)

Economy

At the time of sharpie use in the Chesapeake Bay, the last quarter of the 19th century, there was a massive economic transition occurring. The Antebellum South was in a political and economic upheaval in the aftermath of the Civil War. Agriculturally based, the South was now at a loss for labor with the abolition of slavery, and the war-torn land was in a painful economic slump. However, the means for recovery were invented in the previous decade.

In the 1850's, shortly before the Civil War commercial canning factories had begun in Maryland and New York, largely to preserve lobster and oysters. During the Civil War, the canning industry was preoccupied with providing food to troops. After the war was over, canning factories were used for commercial interests rather than the war effort (National Canners Association 1959:10). By the 1870's, mechanized canning factories became widely available which created an opportunity for the oystermen of the Chesapeake Bay. Commercial canning

machines allowed for the oysters caught in the Bay to be shipped via railroad countrywide without spoiling. This new available market led to an economic shift in the area around the oyster fishing and canning industries. By the late 19th century, the Chesapeake Bay was the single largest source for oysters in the world (Pelton 2010:4). This offered opportunity in an otherwise desolate economy and became the driving factor for development of many vessel types, including the sharpie.

Transitional Forms

The Chesapeake Bay offers a unique look into the use of sharpies and other oystering vessels and serves as a prime example as to how the environment can affect shipbuilding, design, and practices. Prior to the 1870's in the Chesapeake Bay, the main vessel of choice for local fishermen was a local version of the log canoe. These Chesapeake log canoes were a European alteration of the Native American log canoe design mentioned earlier. To handle the deeper, rougher waters of the Bay, the log canoe needed increased stability. To account for the water conditions, Chesapeake log canoes generally consisted of multiple logs tied together to create a flat bottomed, cheap, lightweight vessel (Parker 2007:11). These log canoes were designed and operated with the same principles of the Native American log canoe but with increased size and stability.

Chesapeake Bay Sharpies

Catalysts for Development

The Chesapeake Bay sharpie was influenced, much like its New Haven predecessors, by a combination of environmental and economic factors. The differences in these factors

stimulated the changes to the sharpie design and use. The main factors that affected the development of the Chesapeake Bay sharpie include:

- 1) Deeper, rougher water conditions (Environmental)
- 2) Longer distances to market (Environmental)
- 3) Disintegration of plantation agriculture after 1865 (Economic)
- 4) Popularization and availability of mechanized canning (Economic)

These four main factors interacted to spur the development of the unique but easily accessible workboat that could meet the requirements of the Chesapeake Bay's environment and economy.

The rough water conditions and longer distances to market necessitated a more robust vessel but the faltering economy demanded a cheap and accessible one (Chapelle 1951:305). As the majority of the Chesapeake Bay struggled to shift from a plantation-based economy and the other half struggled to recover from the ravages of war, the citizens of the Chesapeake Bay struggled to find new ways to survive (Pelton 2010:4). The advent and availability of mechanized canning offered an opportunity to take a long standing cultural tradition in the Chesapeake Bay of oystering and fishing and turn it into a large scale, profitable industry (National Cannery Association 1959:13). All that was needed was a workboat that could handle the environmental conditions, be built cheaply with local materials, and carry the valuable oysters to market. The setting in the Chesapeake Bay was ripe for the entrance of the sharpie vessel.

It is not certain whether the concept of the sharpie migrated south from the Northeast or if it was invented independently (Parker 2007:4). Although it would seem natural for the sharpie concept to be diffused to other fishermen in nearby areas, there is no record of this. The sharpie type may have arisen independently because of similar environments and purpose. Much like the concept of convergent evolution in biology, it can be argued that the sharpies in each area are

completely unrelated but bear similar characteristics because of shared purpose and environment, much like a dolphin and a tuna.

Characteristics

The late 19th century proved to be a very active time for ship design in the Chesapeake Bay. This boom of vessel construction led to some historical confusion over the classification of some vessel types. At this time period, there are records of the following vessel types being used in the Chesapeake Bay for fishing and oystering:

1. Sharpie/Beamy sharpie
2. Hampton flattie
3. Skipjack
4. Bateaux
5. Bugeyes and brogans
6. Terrapin smack

In the literature, there is some confusion as to which vessels these terms apply. In some documents, they are all used interchangeably to refer to a modified V-bottom, which is a sharpie-like oystering boat used in the Chesapeake Bay. Some researchers insist that each of these terms refer to a specific and unique vessel type. Others contend that some are interchangeable with some terms but not all. Therefore, the researcher is presented with a conundrum of a mass of information to sort through that has no definitive right or wrong answer. For clarity, this research will treat each term as a reference to a specific and unique vessel. It will help to sort out these vessels and their uses in order to more fully understand the economy and culture of the area in this time period.

Sharpie/Beamy Sharpie

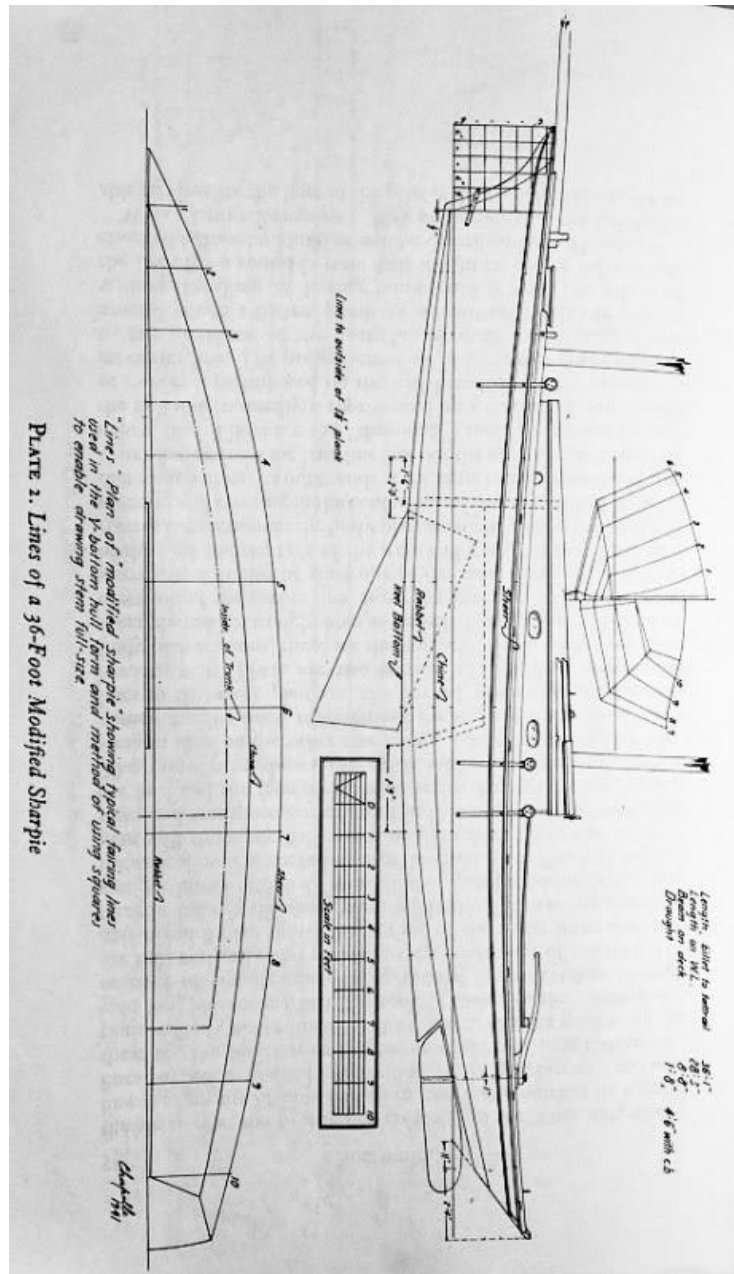

FIGURE 13. Howard Chapelle's Modified sharpie design (Parker 2001:38)

The earliest example of a sharpie-like vessel to appear in the Chesapeake Bay was the sharpie/beamy sharpie in the 1870's (See Figure 13). The Chesapeake Bay was influenced by

one shipbuilder in particular, Thomas Clapham of Long Island. Thomas Clapham was constructing sharpies in the early 1870's and his models were some of the first to be seen in the Chesapeake. He developed a more yacht-like sharpie referred to as the Roslyn Type, named after Clapham's hometown (Kunhardt 1889:40). This type had little deadrise in bow and stern, had a flat bottom amid ships, and many were yawl rigged, which resembles a cutter but has a jiggermast at stern which carries a small sail (Desmond 1998:26) (See Figure 14).



FIGURE 14. Yawl rigged yacht off coast of New Haven Connecticut circa 1900 (Mystic Seaport 2014: Image 1971.230.29)

The Roslyn Type was a combination of traditional New Haven characteristics, like a partial flat bottom, and new additions like the yawl rig. This type was common in the Chesapeake Bay early on, and it has been suggested that this was the direct ancestor to the V-bottom skipjack (Kunhardt 1889:41).

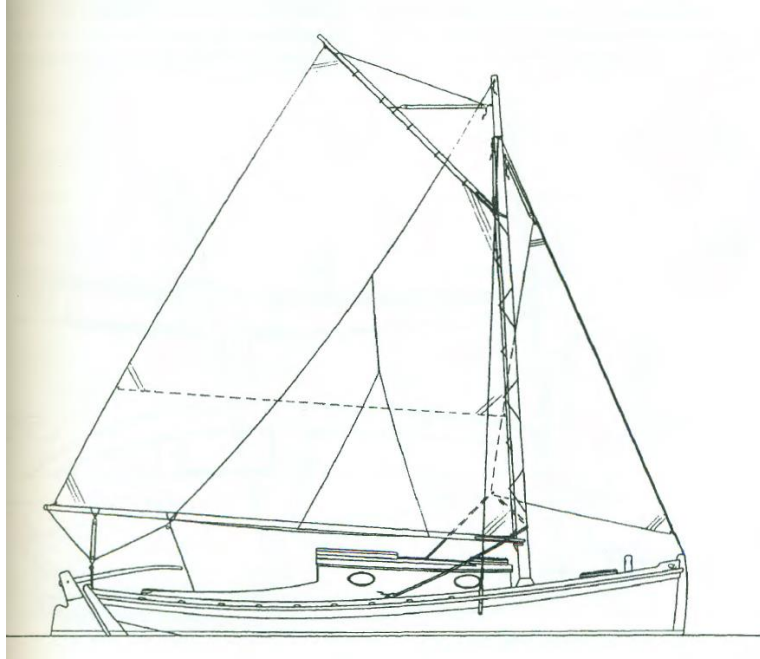

FIGURE 15. Maryland Sharpie. Length: 25 feet, Beam: 7 feet, Draft: 1 foot, $\frac{3}{4}$ inches (Parker 2007:121)

As the Roslyn Type was adopted, it began to take on specific Chesapeake characteristics that would further distinguish it from its New Haven predecessors (See Figure 15). The sharpie in its New Haven form was not particularly popular in the Chesapeake Bay because of the travel distances. The Chesapeake necessitated a vessel that was larger and more burdensome, usually with a cabin. However, other than the distance to travel, the water conditions were very similar to that of the Long Island Sound: rough, uncomfortable, and shallow. These environmental similarities were the driving factor behind why a sharpie-like vessel was originally introduced and used in the Chesapeake Bay (Chapelle 1951:104). Similarities between the two types include square sterns, curved stems, strong flare, flat bottoms, sharply raking transoms, daggerboards, balanced rudders, and leg o'mutton top sails. However, the Chesapeake Bay type bore masts that were more sharply raked and had a higher sprit boom than the New Haven type (Parker 2007:12).

Hampton Flatties

This term seemed to refer to early Chesapeake Bay sharpies that had very slight alterations from their New Haven predecessors. Flatties were sloop rigged, rather than yawl rigged like the Roslyn Type. The sloop rig had always been preferred in the Chesapeake Bay, even being used in canoes. This seems to be the first major alteration that the oystermen of Chesapeake made to the sharpie vessel (See Figure 16). These vessels also became more beamy and were given a little deadrise aft to improve sailing abilities. The flatties were usually gaff-rigged sloop with no bowsprit and no cabin. These vessels were relatively small, rarely reaching over 30 feet (Kunhardt 1889:250).

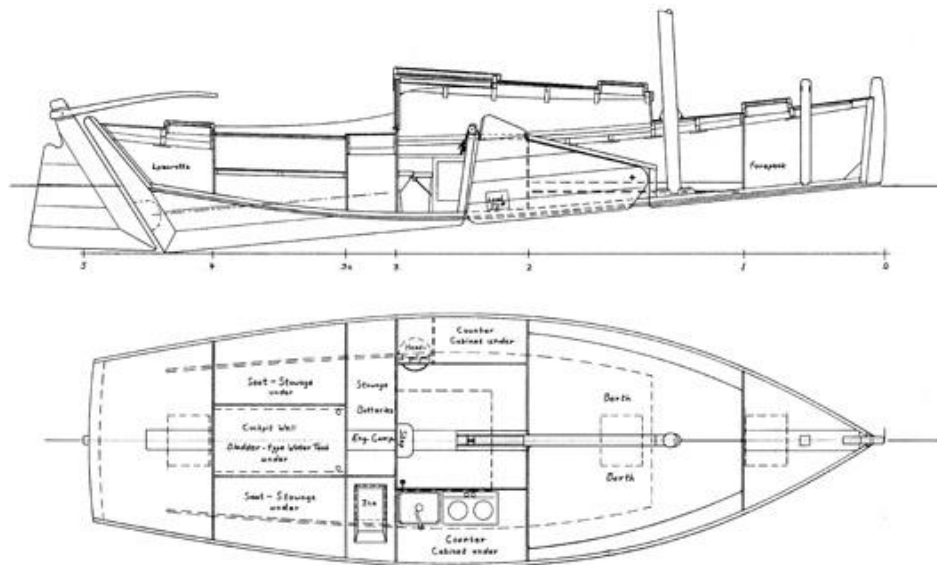

FIGURE 16: Design of Hampton flattie based off of Kunhardt's plans. Length:24 feet, 2 inches, Beam: 7 feet 9 inches, Draft: 2 feet 8 inches (Parker 2007: 119)

Bateaux

The Bateaux and the Hampton flatties overlap in time periods. The bateaux appeared to be used as a broader term that refers to a small, narrow, flat bottom boat (See Figure 17). These vessels were sometimes described as leg o' mutton sloop rigged. They were completely open and most were double enders (Parker 2007:15).

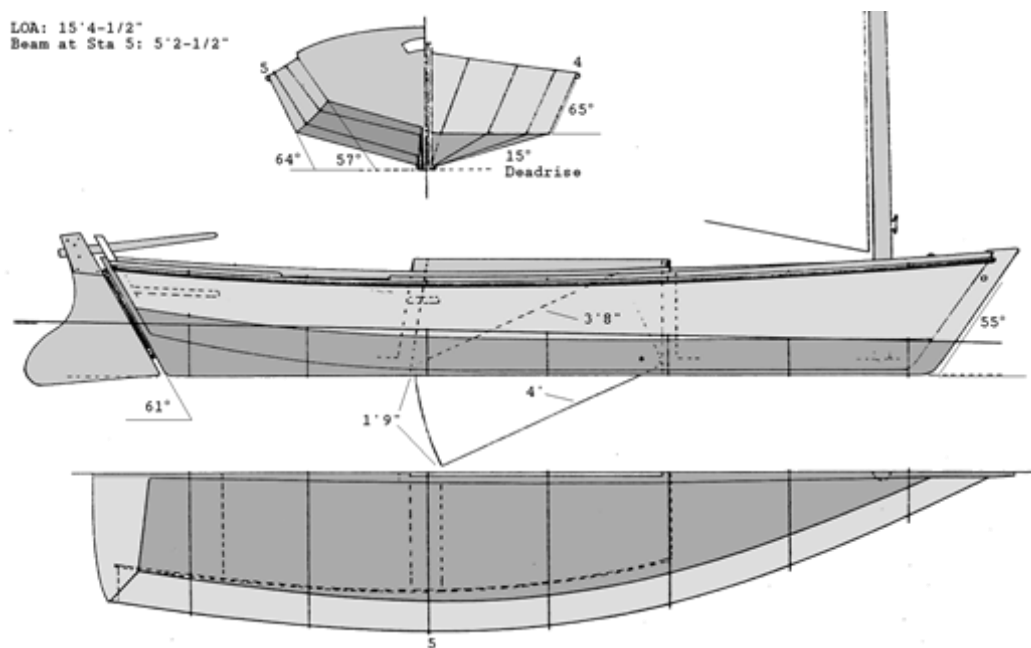

FIGURE 17. Plan of Chapelle's Seaside Bateaux 13 foot, one sail (Chesapeake Bay Maritime Museum Collection 2014)

Bugeye and the brogan

The bugeye and the brogan were two of the earliest and longest lasting forms of oystering vessels in the Chesapeake Bay. Both directly descended from the log canoe; the bugeye and the brogan seem to represent the evolution of the log canoe. The brogan appeared to be the transitional form between a log canoe and a bugeye. The earliest forms of these types were large canoes, or "coasting canoes," that had a foremast and a removable mainmast. The early versions,

from 1800-1825, were 35-40 feet and a result of demand for oysters and the depletion of near shore oyster beds. The traditional log canoe was not sufficient to handle the deeper, rougher waters of the Chesapeake Bay. When dredging became the more efficient and popular method amongst oyster men in the bay, the coasting canoes, or brogans, were embellished and strengthened to withstand the strain. At the close of the 19th century, they became closer to 40-45 feet in length and had fixed masts and a cabin, the form that is generally referred to as the bugeye. Before the 20th century, there was still a relative abundance of raw materials in the Chesapeake area to make these altered, sophisticated log canoes. When materials became scarce, the oystermen of the Chesapeake simply switched over to constructing the bugeye hulls out of frames and planks while maintaining the hull shape and design (See Figure 18). Like many of the other Chesapeake Bay vessel types, the log canoes, brogans, and bugeyes coexisted in the Chesapeake Bay. All three vessels were in use at the same time, and the terms could be used interchangeably depending on the locale. Eventually, the smaller, more efficient skipjack pushed the bugeyes out of popularity in the Chesapeake Bay, though some were in use well into the 1930's (Burgess 1975:15-17).



FIGURE 18. The bugeye J.C. Armiger (Circa 1890) Maryland (Mariners Museum Archives 2014, Image P0001.001)

Skipjack

The Skipjack was the vessel that eventually dominated the Chesapeake Bay. It appears from the historical record, that there was a general progression of development starting with the Roslyn Type sharpie, which led to the Hampton Flattie, which later developed into the skipjack. It is important to note that this progression was not one of creation and extinction. Beamy sharpies, Hampton flatties, and skipjacks were in use contemporaneously in the 1890's on the Chesapeake Bay. It appears that each of these vessel types borrowed from another to create the skipjack.

Another reason why the Chesapeake Bay vessels are difficult to classify and identify is the fact that each type of vessel had multiple versions. For example, some fishermen preferred

their skipjack to sport cat-ketch rigs while others swore by schooner rigged (Burgess 1875:202). So even within each vessel category there is a plethora of variations.

First developed in the early 1890's, the skipjack was a hybrid of old sharpie design and the demands of a new environment. A direct descendant of the sharpie, the skipjack bore many similarities to traditional sharpie. The skipjack design was highly dependent on the non-pareil sharpies and was altered to allow for more displacement. Ranging in size from 28 to 60 ft, the skipjack was the first of these vessels to have a full V-bottom hull. The V-bottom hull was both the biggest difference from its sharpie predecessors and its most distinguishing characteristic. Similar to its ancestor, the skipjack had the same chine in side elevation and showed the same amount of straightness in forward end and loads aft (Chapelle 1951:307). The stern of skipjacks varied: some had a transom, others had an overhang and an inboard rudder (See Figure 19). Long cut water and head rails were highly common on skipjacks, although no specific reason as to the purpose is known. Most were steered with a wheel and both the stem and the transom had a strong rake. The deck arrangements varied by size of the vessel, but if a house was present, it was usually located forward. The skipjack was designed to be operated by one or two men, much like the sharpies. A commonality amongst the different types of rigging was that the shrouds were kept slack to allow flexibility.

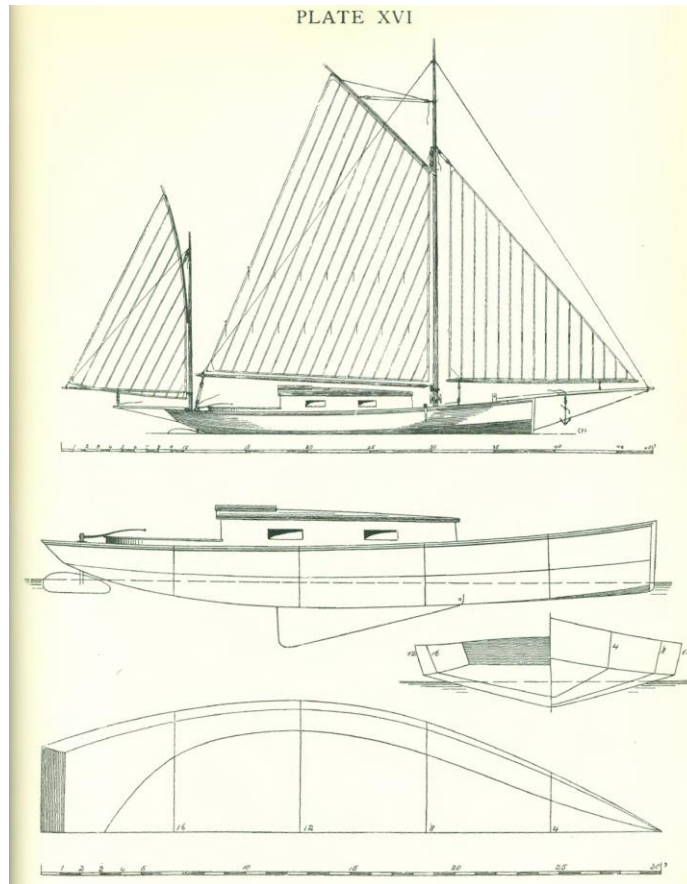

FIGURE 19. Skipjack model designed by Thomas Clapham. Note the movable centerboard, yawl rigging, and a sharpie-balanced rudder. These are all specific characteristics of the skipjack that made it particularly successful (Kunhardt 1889:41).

The skipjack's popularity in the Bay stemmed from the inexpensiveness of materials and the easiness of construction. Mostly used for transporting oysters from flats and bars to shore the skipjack was built and used locally. The skipjack gained popularity rapidly in the Bay over the sharpie for two main reasons. First, with a V-bottom hull there was no pounding when upright. Secondly, skipjacks offered the possibility of employing greater displacement, which ultimately means the ability to carry more product (Kunhardt 1889:40).

The actual construction of the skipjack was very similar to that of the sharpie. Specific characteristics of the skipjack construction included the following: the sides were strengthened

by sheer battens and chine logs; the bottom was cross planked, like the sharpies, at a 45 or 90 degree angle from the hull; the keel was composed of a keelson and a shoe, and there is no rabbet cut into the keel. The skipjack was unique in its use of heavy scantling, usually of yellow pine. The use of yellow pine made it heavier but also a more robust vessel. Over time, two masted skipjacks were not uncommon in the Bay as the larger vessels required greater power to propel them. On the economics of the skipjack, Chapelle pointed out that the skipjack was more expensive than the sharpie. However, it was still cheaper than a round bottom sailing yacht and offered the same advantages of both the sharpie and the round bottom yacht at an intermediate cost (Chapelle 1951: 312).

Terrapin Smack

The Terrapin smack bears resemblance to the Hampton flattie, and its single greatest determining characteristic was the live well in the center where fish could be kept alive and fresh on the way to market (Parker 2007:12). It was a V-bottom boat that maintained the length and width dimensions of a sharpie (See Figure 20). It appears to be an interchangeable term for the Hampton flattie, the difference in name depending on area used and purpose (Kunhardt 1889:255).

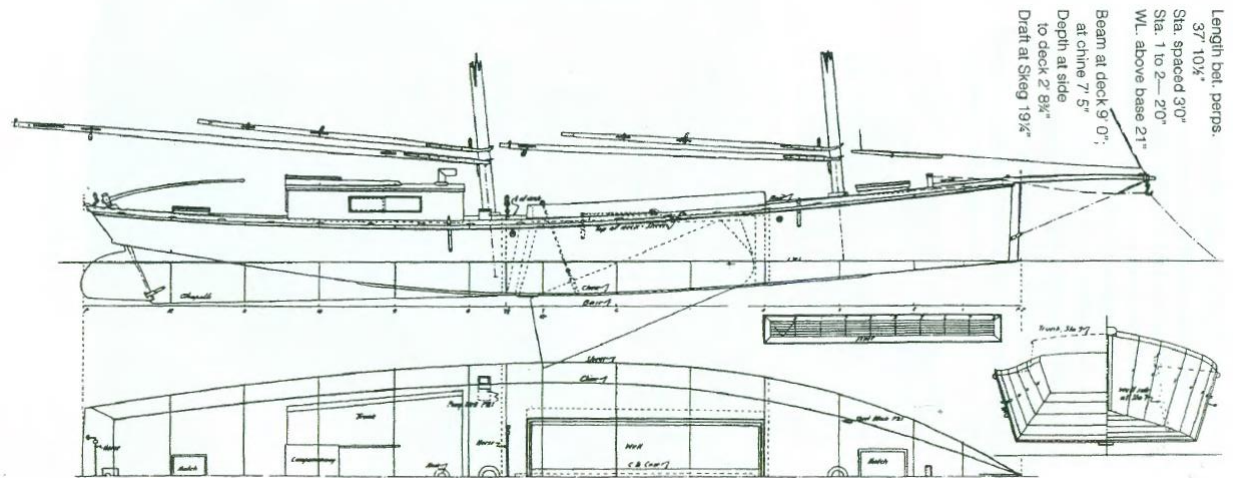

FIGURE 20. Plan of Maryland terrapin smack (Parker 2007:11)

Archaeology

The archaeological record is scant on evidence with respect to sharpies in the Chesapeake Bay. As of today, there are no known examples of Chesapeake Bay sharpies being investigated in the archaeological record. However, it seems that Howard Chapelle, one of the foremost experts in sharpie design and construction, was somewhat of an archaeologist himself. In the mid 1900's, many of Chapelle's designs and plans of sharpies and other Chesapeake Bay watercrafts were based on the local remains of vessels. These vessels were not identified, preserved, or recorded using traditional archaeological methodology, but it is significant that the historical record referenced by present and past researchers on this topic are directly reliant on the physical remains of local varieties of vessels. The evidence for this statement can be seen in Howard Chapelle's research and designs. As one of the foremost experts in the field of small American watercraft, he obtained much of his information firsthand by studying examples of the watercraft in use or the remnants of older craft.

Chapter 4

North Carolina

Environment

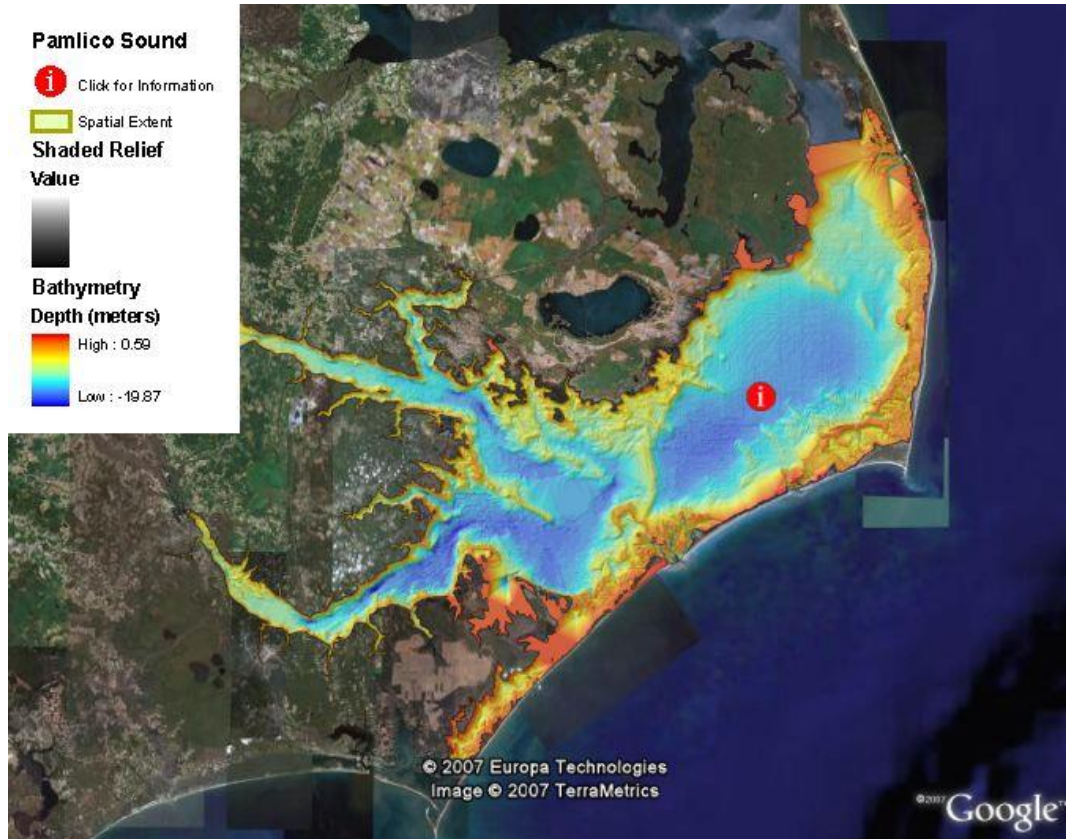

FIGURE 21. Bathymetric map of coastal NC (NOAA 2007)

The coast of North Carolina is dominated by an estuarine ecosystem that is characterized by the low lying lands and the hundreds of small, shallow waterways that segment the landscape. The coast is dominated by the Pamlico and Albemarle Sounds. These sounds are protected from the extremes of the open ocean by the string of barrier islands, the Outer Banks, that stretches from the northern most point of North Carolina and into South Carolina. The Albemarle and

Pamlico Sounds are both shallow with the maximum depth reaching about 20 meters (See Figure 21). Small waterways, marshes, swamps, and shallow estuaries dominate the coast.

However, the other side of the Outer Banks, the Atlantic Ocean, is one of the most dangerous areas for shipping. Referred to as the “Graveyard of the Atlantic,” the ever shifting, shallow, rough, and unpredictable stretch of ocean has claimed hundreds if not thousands of ships (Stick 1983). In stark contrast, the sound side of the Outer Banks offers a calm, shallow, and ecologically rich area that connects to hundreds of shallow waterways that lead inland. The coast of North Carolina offers the rare opportunity to gather resources in the protected sound waters and then transport goods and people inland through the extensive network of waterways.

Economy

Much like the Chesapeake Bay area, the coast of North Carolina had long participated in fishing and harvesting oysters, but less on an industrial and more on an individual, familial level. Also, like the Chesapeake Bay area, North Carolina fell into economic upheaval as the Civil War took its toll. Once agriculturally based and dependent on slave labor, post war North Carolina was in deep economic turmoil. In addition to the problems of the post war economy, the natural layout of the land in coastal North Carolina made easy transport of people and goods a difficult issue. The isolated Outer Banks and other coastal areas had no consistent way of connecting with the mainland of North Carolina (Lewis 2007:3). Roads and bridges connecting the outlying areas to the mainland did not exist until the late 20th century.

Unlike some of the other Southern states, North Carolina held some valuable assets after the Civil War. This, among other factors, led to the construction of railways from the coast to major cities that could carry product (Walbert 2013:2). With demand for oysters increasing, the

decrease of large agricultural ventures, and the ability to ship coastal goods to markets, all that was missing was a reliable watercraft to harvest the oysters.

Transitional Forms

Within the larger sphere of changes in sharpies down the east coast there was also the smaller, more localized sphere of the transformation that the sharpie goes through at each locale itself. Just as in other areas, when the sharpie arrived in North Carolina it did not immediately transform into the final North Carolina sharpie design. It underwent changes and transitions on a local scale to eventually become what was classified as the North Carolina sharpie. This local transformation reveals considerable information about the needs, environments, and economies of particular areas of the North Carolina coasts as it is reflected in the designs and changes made to the sharpie vessel.

The earliest sharpies in North Carolina appeared in the 1880's and were similar to their New Haven counterparts. They were relatively small vessels ranging from 20-25 feet in length and had a square stern. With only one mast and leg o'mutton topsail rigged, one or two people could man the small vessels. These early North Carolina sharpies retained these characteristics because they were used for manual oyster tonging and fishing (See Figure 22 and Figure 23). This phase of North Carolina sharpies is commonly referred to as oyster sharpies.



FIGURE 22. Oyster tonging near Beaufort, NC 1887 (Image 86.105.2949). (Courtesy of NC State Archives 2014)



FIGURE 23. Oyster Boats in Beaufort 1887 (Image 86.105.2950) (Courtesy of NC State Archives 2014)

In the next decade there was a solid transition in sharpie design and usage. In the 1890's, the NC sharpie was built on a markedly larger scale. This version was commonly referred to as

the Core Sound sharpie, and moves away from the New Haven design towards a more schooner-like design. The Core Sound sharpies were generally 40-50 feet long and proportionally wider to accommodate the increased length. Along with the size increase, the tonnage increased drastically, and the majority of these vessels had two masts to provide greater power (Parker 2007:134). Despite the switch to two masts, the majority of the Core Sound sharpies maintained the use of the leg o' mutton rigging. Two of the more famous and well recorded of the 1890's Core Sound sharpies are the *Three Friends* and *Nellie Bly* (See Figure 24).



FIGURE 24. “Sharpie, *The Three Friends*” built in Beaufort in 1893. 43 foot, Core Sound sharpie. Note the use of the two masted leg o mutton sails. (Image 78.086.039c) (Courtesy of the North Carolina Maritime Museum in Beaufort 2014).

The changes to the oyster sharpie resulting in the Core Sound sharpie were responses to growing economic opportunities. North Carolinians soon realized that there was enough of a market in oysters and fish in this time period to make it prudent to increase their production of those products. All of the changes made to the sharpie were designed to allow the fisherman to

bring in a larger haul more quickly (Chapelle 1951:123). Oyster houses began appearing along the sounds of NC providing a readily accessible avenue for selling their hauls.

By the early 1900's, the Core Sound sharpie retained its name but had undergone major changes in design. In the early 20th century, the sharpie became used for a larger array of jobs resulting in physical changes. The sharpie was used less often for oyster tonging as other methods for oystering became more popular. Instead, the sharpie was more widely used for commercial fishing, mail carrying, and passenger transport. Reflecting the changes in usage, the sharpie became even larger, adding up to ten more feet, to accommodate larger loads (See Figure 25). The stern became rounded and the most noteworthy difference was the use of schooner rigging. These versions of the sharpie more closely resemble a schooner than their New Haven ancestors, however they retained their flat bottoms and construction techniques.



FIGURE 25. Sharpie Schooner *Prince* near Beaufort 1905. Note the schooner rigging. (Image 86.105.027) (Courtesy of the North Carolina Maritime Museum in Beaufort 2014)

By 1915, the vessels referred to as sharpies were a far cry from the sharpies that were once used for oystering. And although the name sharpie continued to be applied to vessels, by the 1920's it referred to different types of vessels. The name "sharpie" was used to refer to very small personal recreation craft that vaguely resemble the earliest of New Haven sharpies (See Figure 26).



FIGURE 26. Fishing on a sharpie at the Onslow County Club circa 1930 (Image 86.105.018)
(Courtesy of the North Carolina State Archives 2014)

On the other end of the spectrum, "sharpie" was also used to refer to the Core Sound style sharpies still in use (Sucher 1973:340). These late Core Sound sharpies were a mixture of schooner and sharpie characteristics that are mainly employed in fishing and human transport. The *Julia Bell* was one of the later Core Sound sharpies that exemplify the hybrid of schooner and sharpie (See FIGURE 27).

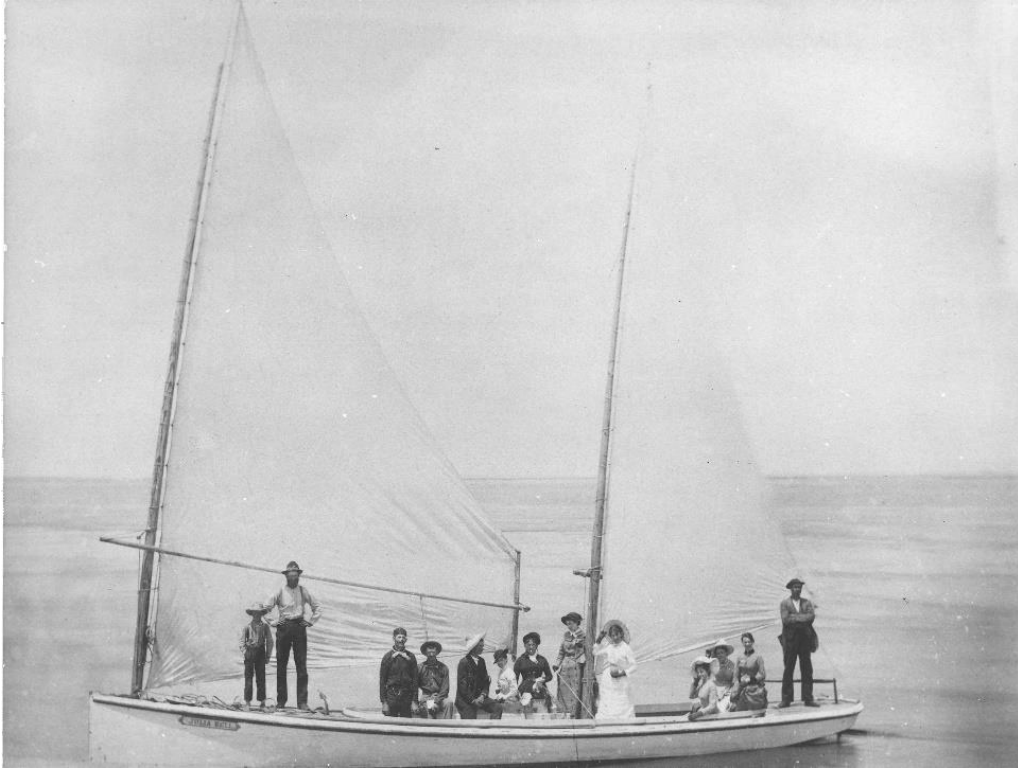

FIGURE 27. The *Julia Bell* (Image 78.052.039) (Courtesy of North Carolina Maritime Museum in Beaufort 2014)

North Carolina Sharpie

Catalysts in Development

As the 1870's approached, the coast of North Carolina was going through significant economic and cultural changes that, when combined with the natural environment, resulted in the development of the highly specialized sharpie. Much like the Chesapeake Bay, antebellum North Carolina economy and culture were in a period of transition as slavery was abolished and traditional ways of life were no longer an option. The sharpie became pervasive and deeply important in the sounds surrounding North Carolina for four main reasons:

- 1) Very large, shallow sounds and waterways (Environment)
- 2) Lack of infrastructure (Economic and Environment)

3) Lack of industry (Economic)

4) Market growth (Economic)

Much like the Long Island Sound, the sounds of North Carolina are very shallow which required a workboat that could carry a load of product but draw very little water (Parker 2007:14). In addition, the coast of North Carolina is so interspersed with swamps, marshes, bogs, sounds, rivers, estuaries, and rivers it was nearly impossible to construct roads to connect the coast to the large markets of Eastern North Carolina (Lewis 2007:3). Therefore, for many years, the best way to transport goods and people in North Carolina was by boat. After the Civil War, there was no longer a plantation economy but neither were there the resources, capital, or the population to support large industry, limiting the livelihood options of Eastern North Carolinians (Walbert 2013:2). However, the combination of the growth of the railroads and the canning industries spurred the growth of the oyster market, which provided increased demand for the product of the oystermen of the Outerbanks (Parker 2007:18). These factors worked together to necessitate an inexpensive, locally made, versatile boat that would eventually evolve into the North Carolina sharpie schooner.

Characteristics

The changes made to the sharpie after its introduction into North Carolina were highly dependent on the methods of oystering in the South. In North Carolina, tonging was not the favored method of oystering, dredging being more commonly used (Parker 2007:16). Dredging was a process that was becoming mechanized and therefore more efficient than its handheld counterpart. The dredge was similar in concept to that of the tongs, being composed of large

scraping teeth to detach the oyster from the substrate. The dredge was designed to be dragged behind the vessel scraping down (See Figure 28).

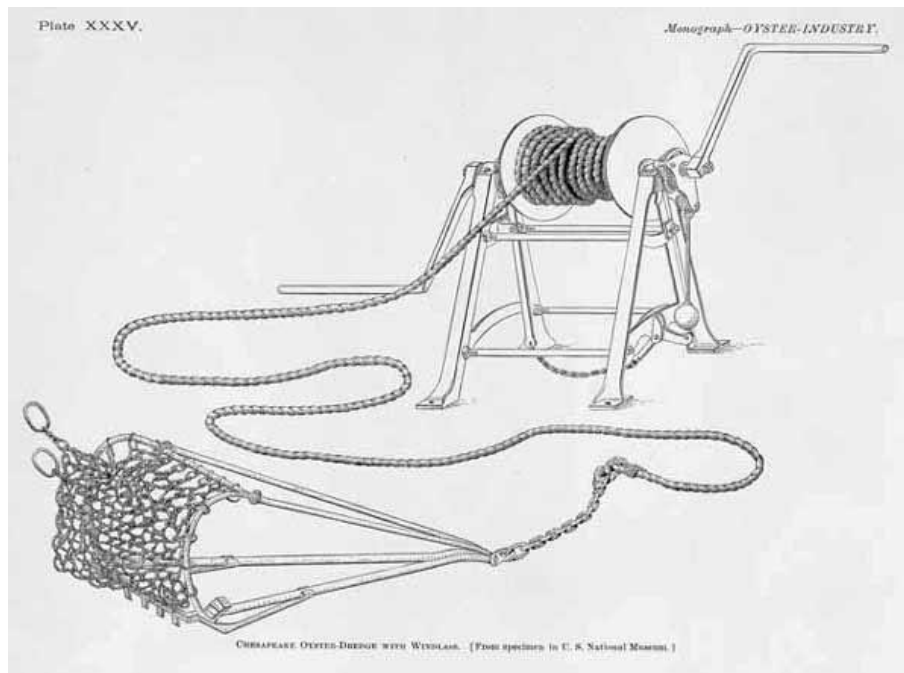

FIGURE 28. Early oyster dredge (Courtesy of the Mariners Museum *The Oyster Industry* by Ernest Ingersoll)

The dredge has a net attached that was designed to catch whatever the teeth dislodged from the substrate (Getchis et al. 2006:3). The dredge and net would then be hauled out of the water onto the vessel, emptied, and the contents sorted. Once empty, the dredge would be placed back in for another pass. This technique was generally more efficient than tonging but also required significantly more power to tow the dredge effectively behind the vessel (See Figure 29). The need for more power prompted size and rigging alterations in the North Carolina sharpie.

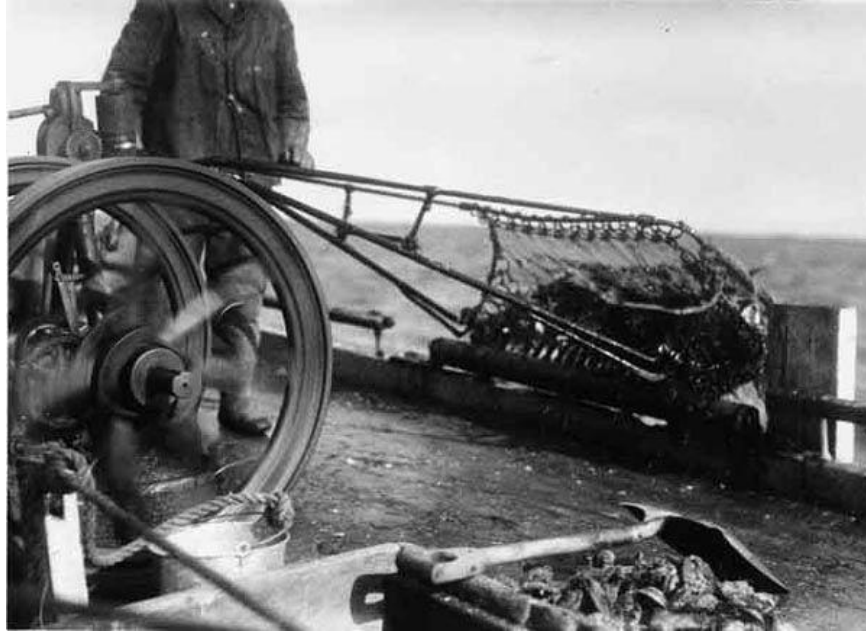

FIGURE 29. Oyster dredging in Chesapeake Bay, use of small motor to tow dredge back in the boat (Courtesy of the Marines Museum Library 2002)

The two largest differences between the North Carolina sharpie and its predecessors were its size and the rigging. The North Carolina sharpies were commonly 40-45 feet in length, much larger than the New Haven or Chesapeake versions. An additional difference was the use of gaff rigging as opposed to the more traditional yawl or leg o' mutton rigging. These two changes tended to go hand in hand. As a vessel becomes larger, it needs a more powerful rigging system, and conversely as a rigging system becomes more powerful the vessel size needs to increase proportionally to handle the power (See Figure 30). By the last stages of development, in the sounds, some sharpies would reach up to 60 feet in order to provide the power needed for dredging profitably (Parker 2007:18).

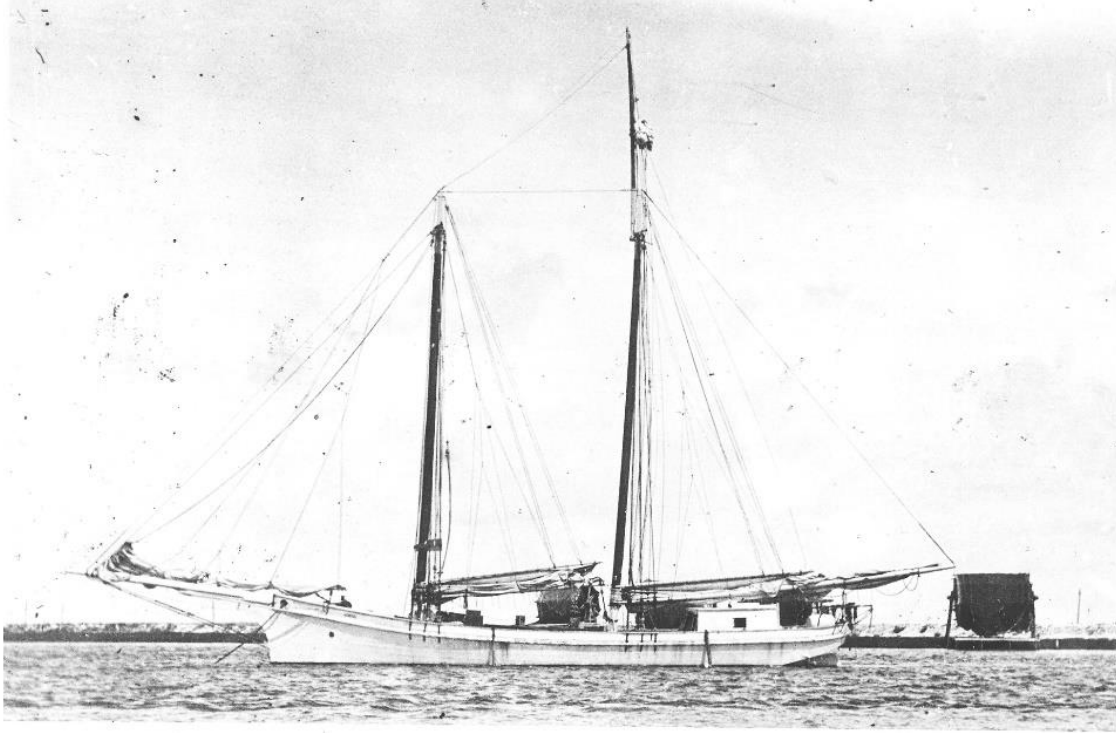

FIGURE 30. Sharpie Schooner anchored near Beaufort in 1905 (Image 86.105.020) (Courtesy of North Carolina State Archives 2014)

The reason behind these alterations to the sharpie design lies within its use. The sharpie was widely used in NC as a fishing and oystering vessel just as it had been in New Haven. However, over time the sharpies became used for much more, including mail, passenger, and freight carriers. These jobs still necessitated a flat bottomed ship that could transverse shallow waters but needed more strength and power to handle larger cargoes. These needs translated into a vessel that still bore many characteristics of a New Haven sharpie, but in a larger, more robust scale to fit the particular needs of the area.

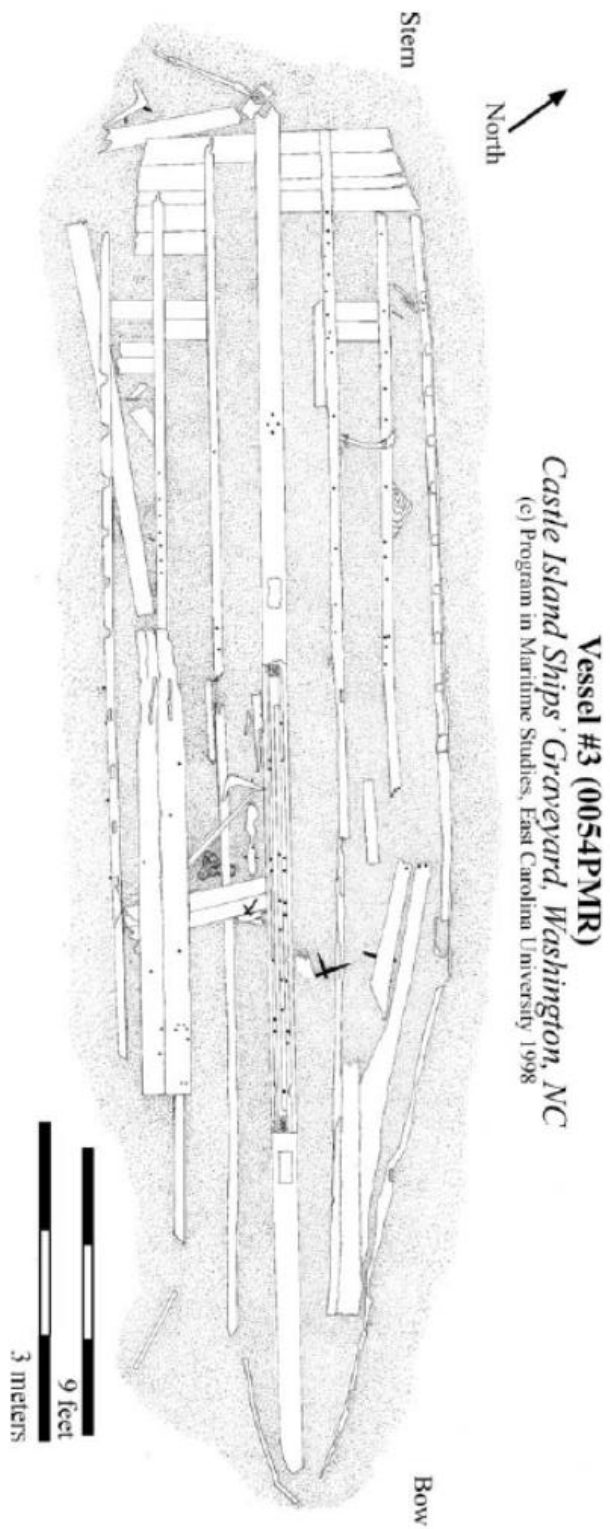

FIGURE 31. Plan view of Vessel 3 (Rodgers 2006:33)

Archaeology

Castle Island has had a long history of maritime activity stretching back well into the 17th century. A hotbed of activity during the Civil War, Castle Island continued to be used well into the twentieth century as a wharf. Located across from the city of Washington, Castle Island served as an important loading and unloading area for the shipping trade coming in and out of Washington. Because of this rich history of maritime activity, in 1998 ECU decided to hold a field school that concentrated on the investigation of the area surrounding Castle Island. During the archaeological field school, the project leaders documented a total of eleven different vessels surrounding the island. Of these wrecks, one turned out to be an example of a North Carolina sharpie.

The vessels researched in this field school were initially found by sighting them from the surface of the water, all of the wrecks being in very shallow conditions. After locating the target wrecks, divers were deployed on visual reconnaissance tasks to record and study the wrecks. In 1998, divers investigated the sharpie Vessel #3 (See Figure 31) through a Phase II non-disturbance archaeological survey. The archaeologists/divers recorded all objects in situ, and did no excavation barring hand fanning. The site was drawn to scale underwater to be combined later for a full site plan.

A site plan of the vessel in plan view was constructed using the measurements taken by the divers. The site plan of Vessel 3 shows a sharpie like vessel with some telling characteristics. The vessel was definitely flat bottomed, indicating a vessel with a shallow draft, both characteristics of the sharpie vessel type. The vessel also had a pointed bow and a raked transom stern, both of which were known to appear on sharpies in North Carolina, though are not

particularly indicative. The vessel contained an internal keel and two mast steps. It was not entirely intact, but researchers estimated the dimension to be 35 feet long and 8 feet wide, with a draft no deeper than 3 feet. These dimensions would coincide with that of a small oystering sharpie. Very importantly, a centerboard and rudder remained intact. The combination of the flat bottom, shallow draft, movable centerboard, balanced rudder, and long narrow dimensions combine to indicate a local variant on the sharpie. The planking was athwartship, as opposed to the more traditional herringbone pattern, which was most likely a local variation. Combine this evidence with the fact that the areas surrounding Castle Island were some of the busiest oystering houses and grounds, and it all adds up to create a very likely scenario that Vessel 3 is, in fact, a sharpie.

Unfortunately, Hurricane Floyd hit the area of Castle Island in 1999. This hurricane caused so much damage and so much sediment shifting that the site could no longer be found. This eliminates any chance that researchers today have of going back and re-examining the wreck again to look for more details or to do more excavation on this rare archaeological find (Rodgers 2006:28-33).

Chapter 5

Survival during the Era of Steam and Internal Combustion

The heyday of the sharpie vessel, in any of its forms, was from the 1850's to 1920's. This time period overlaps with the overwhelming conversion of sailing to steam (See Figure 32). So why, when other types of sail propelled vessels were obsolete, did the sharpie not only continue to exist but to be produced and widely utilized? The answer, like so many other aspects of the sharpie, lie in a combination of economy and ecology.

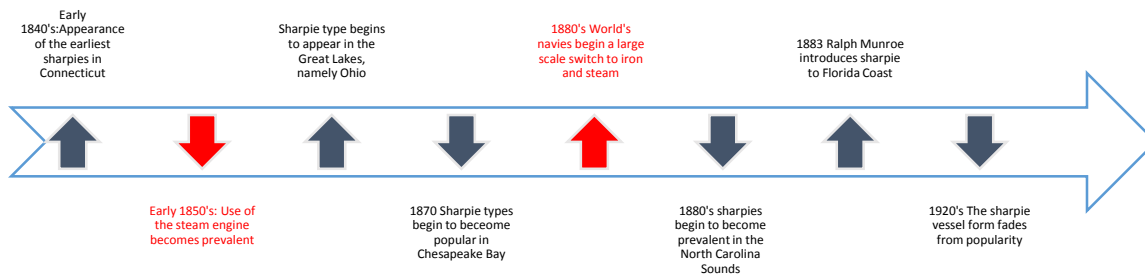

FIGURE 32. Timeline of Sharpie and Steam

Despite these developments, the wooden, sail driven sharpie continued to thrive and improve. After 1850, when steam power began to make leaps and bounds in efficiency, it still remained economically out of reach of the average American. Both steam engines and iron hulls were not easy to construct nor were the materials highly accessible. The steam engine itself, took considerable engineering and highly specialized manufacturing and construction technique. Even as the steam engine became more widely used and produced in the 1850's it was still not adopted

significantly by the public (Kemp 1978:145). Despite its increased efficiency and availability, the steam engine was even less practical for the average American because it could not be successfully applied to the widely available and popular wooden ships. The nature of the steam engine, its power, weight, and use of fire, meant that the combination of the engine type and wooden ships presented a problem. Wooden hulls, generally, could not withstand the power of the engine, being at risk of destroying the hull with the torque. Additionally, the coal burning engine produced significant risk of fire when placed on a wooden ship. Finally, the sheer weight of the engine was a problem for the wooden ships, necessitating more robust hulls and larger design. These characteristics of the steam engine meant that the majority of the time, it was best utilized with an iron hull. Iron hulls were not only more expensive and made of less available materials, but they could not be constructed by the individual, as wooden hulls had for so many years.

Though the navies and larger merchant groups began to switch to steam power and iron hulls in the 1880's, the majority of fishermen and oystermen did not have the capital, materials, or the knowledge to build the internal combustion engines or the iron vessels to accompany them (Kemp 1978:152). The Civil War further exasperated the situation, leaving a torn and broken nation in its wake, decreasing the available capital to individuals. Particularly in the South, industrial materials like coal, oil, iron, and the factories necessary to produce parts for steam powered engines were practically non-existent.

As the 20th century dawned, there was finally a more substantial shift in the use of steam power and iron. The burgeoning railroad, oil, and steel industries and the advent of mass production made the availability of parts and materials more accessible and affordable (Walbert 2013:2). The percentage of steam powered ships finally began to overtake the sailing population

and more and more sailing vessels were used for pleasure or sport. However, as the rapid improvement and changes in marine engines and propulsion technology progressed, many found it impossible to keep up with the changes. For many, expending the capital to produce, maintain, and update the new engines and parts was nearly impossible (Lucke 1921:13).

In the rural and more isolated areas of the country, wooden sailing vessels persist for three main reasons. First, the ecosystem readily provides materials. Wood can be obtained easily and cheaply. Secondly, the construction process itself is relatively quick and inexpensive. And finally, there is a deeply seeded cultural tradition in the areas like Chesapeake Bay and the coast of North Carolina. The knowledge and designs of the fishing and oystering vessels had been passed down through generations. The traditions of each locale still persist today, where you can still see men constructing their own wooden vessels like their father and grandfather did before them. In these coastal cultures, the wooden sailing vessels, particularly the sharpies, are part of their heritage. These vessels are not simply built for use, but as a connection and in respect to the culture that formed them.

The continued use and popularity of the sharpie during this time period was dependent on two main factors. Firstly, the steam engine and iron hulls were largely unattainable to the majority of the American population due to scarcity, high cost of materials, and the necessity of factory made parts. Secondly, the tradition and connection to wooden shipbuilding and use was highly prevalent throughout the coastal communities of the East Coast. The cultural tradition continued to prevail as the local fishermen and oystermen maintained a connection with their culture and communities well into the 1900's. These factors helped to ensure that the wooden sailing vessels, including sharpies, persisted well into the Era of Steam and Iron.

Chapter 6

Alternative Forms of the Sharpie

Great Lakes

The sharpie vessel form was not restricted to the East Coast of the United States. In fact, variations of the sharpie form spread down to the coast of Florida and over to the West Coast. The sharpie form was also widely used on the Great Lakes. The sharpie vessel's inexpensiveness and versatility made it a clear choice for mariners all over the country and in all different environments. The forms used in the Great Lakes and off the coast of Florida were fairly close both in time period, design, and usage to the sharpie forms that migrated down the East Coast in the late 19th century.

In the late 1870's, sharpies began to appear in the Great Lakes area, namely Ohio. The nature of Great Lakes fishing was unique and required a specific type of vessel. However, the sharpies of the Great Lakes were used for different purposes and in different environments than their coastal counterparts (See Figure 33 and 34). The Great Lakes presented their own array of challenges completely different from the coast including ice, fresh water, canals, and severe, unpredictable weather. It would seem that these deep, glacier-created lakes would not have much use for a vessel that proved so useful in shallow, saltwater environments. However, with some fortification and bolstering the sharpie would once again prove its versatility as it began to dot the horizon of Lake Erie.



FIGURE 33. Map of Great Lakes that cross into United States. Red area demarcates that area of the Lake Erie that bore the most sharpie activity (US Army Corps of Engineers 2014)

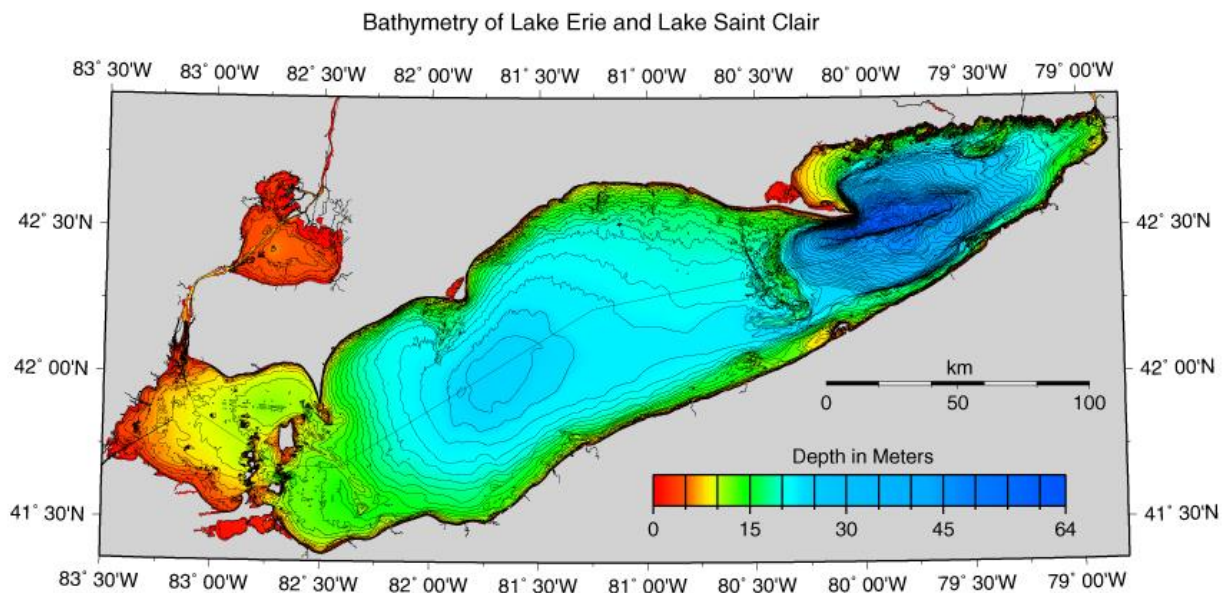

FIGURE 34. Bathymetric Map of Lake Erie. Note that the depth and the general bathymetry of the lake is significantly disparate from that of the coastal environment where sharpies have elsewhere been employed (NOAA 2014).

It is not known for sure how the sharpie came to be used in the Great Lakes, as it does not resemble the New Haven version very closely and there are no historical records detailing its

migration. However, it has been suggested that because much of Ohio was settled by people from Connecticut and Massachusetts the general idea migrated with the settlers (Chapelle 1951:126). Chapelle even suggests that based on the Great Lakes sharpie design they are, in fact, more likely to be either independently formed or to have been developed from the New England flat iron skiff (Chapelle 1951:126). The Great Lakes sharpies were used in a few specific areas, primarily the shores of Lake Erie, the Ohio coast, and the mouths of the Huron and the Black River (Parker 2007:15). Unlike, the sharpies of the coast, the Great Lakes sharpies were not used for oystering. They were used for a wide array of tasks but most commonly for pound net fishing (See Figure 35). This was a burdensome, heavy task that necessitated a strong vessel that could operate near shore, in shallower waters. Pound net fishing entails a great deal of work, starting with driving stakes into the lakebed. Then a large, heavy “pound net” was strung from one stake to net next forming one long fish trap. This long, secured net effectively creates a stationary trap for any fish that swim into it. The fishermen then haul up these nets to check for their catch (Mariners Museum 2002). This kind of fishing obviously requires a stable, robust workboat that can handle the abuse of everyday work and suit the needs of the Great Lakes environment.

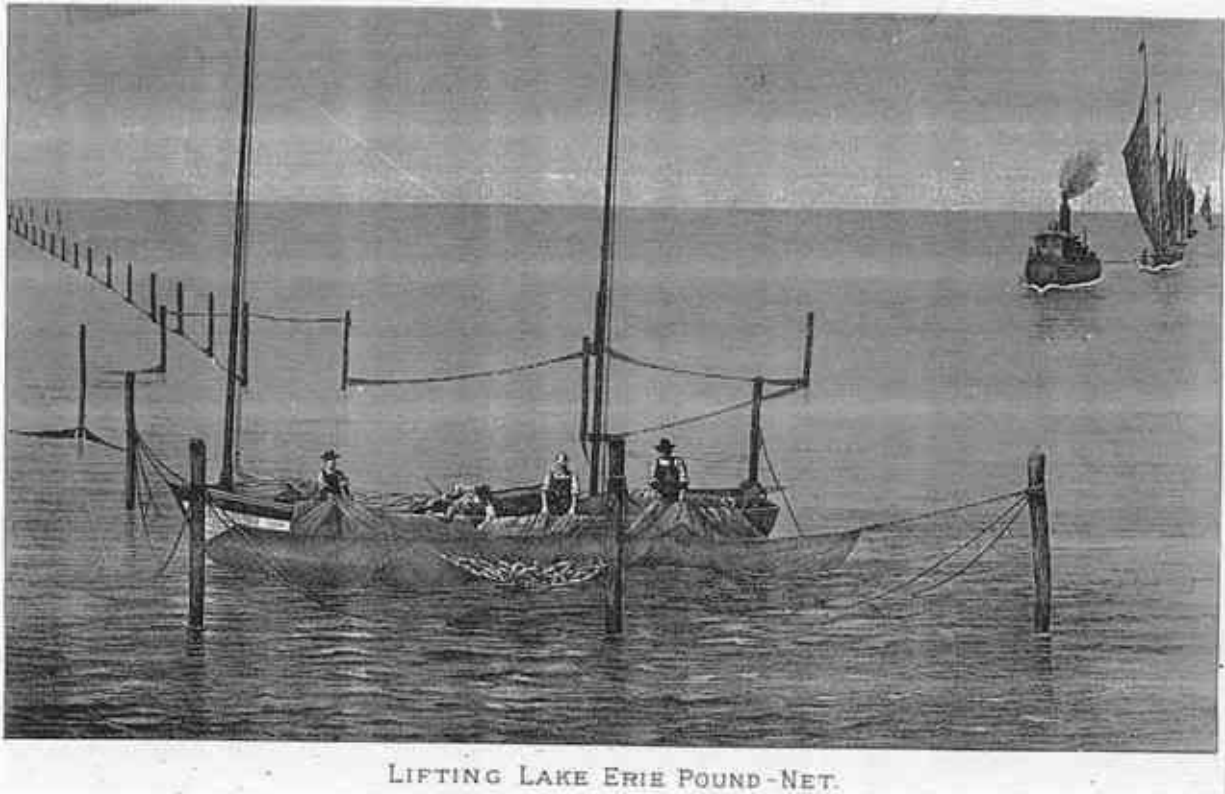

FIGURE 35. Picture of fishermen lifting a pound net on Lake Erie (1887 Fisheries Commission Report 2014)

Over time there came to be three different types of Great Lakes sharpies: Ohio sharpie, Erie sharpie, and the Lake Champlain sharpie. The Lake Champlain sharpie was first introduced in the 1870's. Reverend WHH Murray introduced them and they were used for pleasure boats and occasionally for workboats. The Lake Champlain sharpies highly resembled their New Haven counterparts in hull design. The biggest signifier of the Lake Champlain type sharpie were the multitude of rigs that were used on them in experimentation. Rigs used included two masted, boomed leg o' muttons. A combination of boom and batten was tried along with gaff sloops and interminable variations (Chapelle 1951:126).

The Erie sharpie is thought to have been developed from the Ohio sharpie (Parker 2007:13). The Erie sharpie and the Ohio sharpie seem to be very similar in hull design and in

construction, their biggest difference seems to be in the rigging. Though the Erie sharpie was said to have been developed from the Ohio version they overlap temporally and coexist. The Erie sharpie seems to be simply a continuation in experimentation with improvement on rigging on the Great Lakes sharpies. For the sake of clarity and simplicity, the term Ohio sharpie will refer to both the Ohio sharpie and the later Erie sharpie unless otherwise specifically noted as most of the hull construction and details are the same. When the issue of rigging design arises, the two types will once again be addressed separately.

In 1881, sharpies began to be built out of Sandusky, Ohio on Lake Erie. These first vessels were constructed by George Littleton, a boat builder from Virginia. Though these sharpies did not highly resemble the other existing sharpies, the fact that the first builder in the Great Lakes was a builder from an area that extensively used the sharpie supports the idea that the Ohio sharpie may be based on the general idea of the East Coast, Chesapeake type sharpie. Unfortunately, the majority of these Ohio sharpies were built by professionals and amateurs alike with no written plans, eliminating the written record. The Ohio sharpies were proportionally much larger and more robust. The hulls were heavier, beamier, and had square raking transoms. The rigs were lofty and resembled a gaff rigged with topsails. The average size of the Ohio sharpie was 36 feet long, 10.5 feet wide, and 3 feet deep (Parker 15:2007). Ohio sharpies ranged anywhere in size from 20 to 42 feet but most were on the much larger size (See Figure 36). Some Ohio sharpies were open and some had narrow covering boards, the majority had square sterns and a balanced rudder hung outboard. The majority were made of white pine with some oak, had a rabbeted stem, and a cross planked bottom (Chapelle 1951:128).

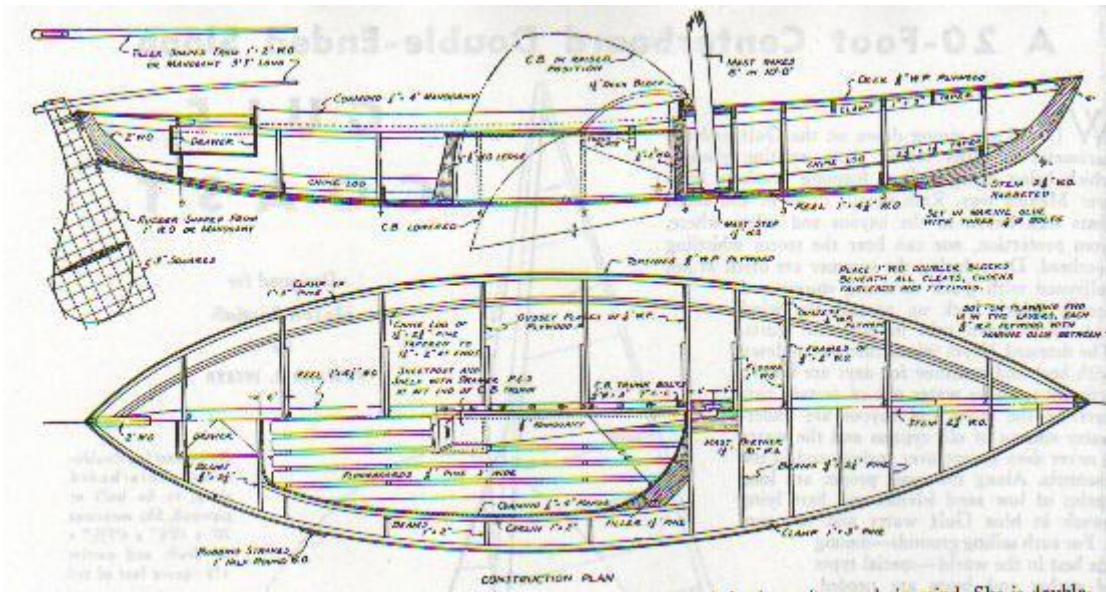

FIGURE 36. Parker’s small sharpie (Parker 2007:110).

Overall, the Ohio sharpies were a much heavier, fuller boat with increased carrying capacity. The Ohio sharpies could carry anywhere from 7.5 tons to 12 tons and still remain fast and manageable vessels. To put this in perspective, a 36 foot Ohio sharpie would weigh about 3,500 pounds but be able to carry 24,000 lbs and still be sailable. The Ohio sharpie presented a rare combination of strength and versatility. This was a vessel that could carry 7 tons of fish to market but could still be safely pulled up onto flats during bad weather (Parker 2007:16).

One of the factors that continued to persist in the sphere of sharpies, regardless of area, origin, or style was the cheapness and easiness to construct. Even though, the Ohio sharpies were much more robust than the coastal versions, it still proved to be more cost efficient and easier to build than the alternative vessels. Once more, the use of simple, readily available materials, the simplicity of construction, and the versatility of this craft proved to be an undeniable factor in the watercraft’s success.

The Great Lakes sharpies were a very different from those in the areas of New Haven, Chesapeake Bay, and the Carolina Sounds. However, there were some key similarities that

connected the Great Lakes sharpies to their coastal counterparts. First of all, the concept of the sharpie was the same in that it was a vessel constructed to be stable, maneuverable, and draw little water. Secondly, it was constructed out of cheap materials, like white pine, and informally produced by locals. On a design level, both the Great Lakes sharpies and the coastal sharpies had a balanced rudder and a movable centerboard. Both of these elements were crucial to the design of the sharpie. With the exception of the Chesapeake Bay sharpies, the others all had a flat bottom, usually bearing a cross planked pattern and a rabbeted keel (Chapelle 1951:126). For the most part, this was where the similarities ended, there was a much longer list of differences than similarities. The biggest difference between the Great Lakes sharpies and the coastal sharpies was the size and proportion. The Great Lakes sharpies were significantly larger and more robust in construction than the coastal sharpies (See Figure 36). The differences are further noticeable when the rigging is examined. The New Haven sharpies traditionally bore a two masted leg o' mutton rig. The Chesapeake Bay and the Carolina sounds bore a much larger array of rigging styles. However, the Ohio sharpies had a very unique rigging that was employed specifically by pound net fishermen. The Ohio sharpies and other pound net fishing vessels used a gaff rigger with topsails (See Figure 37 and Figure 38).

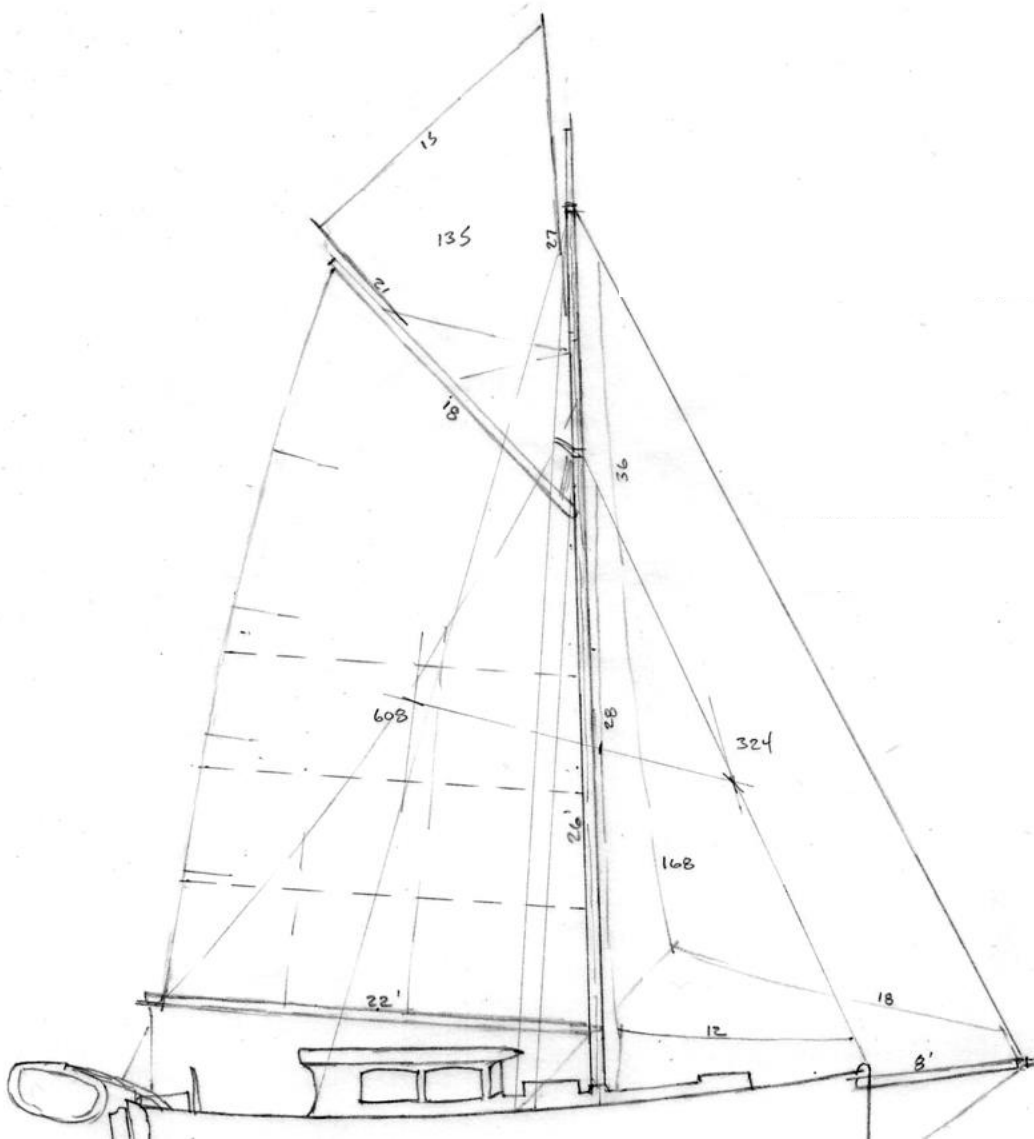

FIGURE 37: Drawing of Gaff rigged topsail, a traditional rig used by pound net fishermen in the Great Lakes (Roberts 2014).

Dimension	New Haven Sharpie (Kunhardt 1889:216)	Ohio Sharpie (Chapelle 1951: 129)
Length	33 ft	36 ft
Width	6 ft	10 ft 2 in
Depth	3 ft	3 ft
Stern	Square or round	Square
Rudder	Balanced	Balanced
Building materials	Yellow pine, some oak	Pine
Foremast	38 ft long	40 ft
Mainmast	35 ft long	42 ft
Rig	Two leg o'mutton sails	Gaff rigger w/ topsails set (Rigging specific to pound net fishermen)
Weight of hull	2,000-2,500 lbs	3,500 lbs
Carrying capacity	5 tons	7.5-12 tons

FIGURE 38. Table to Compare the Average Measurements of a New Haven Sharpie and an Ohio Sharpie

In conclusion, though the Great Lakes sharpies were referred to as sharpies, they were actually quite divergent from the coastal sharpies. Though they had some similarities, the most defining factor of the coastal sharpies, the extremely narrow length to beam ratio, was greatly diminished in the Great Lakes sharpies. As would be expected, the environment of the Great Lakes affected the design, usage, and construction of the sharpie vessels and created a deviation from the coastal sharpies.

Florida

The sharpie was also used in the coastal waters of Florida. The sharpie was brought to the shores of Florida by Commodore Ralph Munroe in 1883. Munroe brought the *Skiperee* to Key West to test it in the local waters, as it was commonly believed that the sharpie would be ineffective in the Gulf Stream. However, the sharpie proved to be highly effective (Parker 2007:18). The coast of Florida is unique in the fact that very shallow shoals and marshes surround it, much like the Carolina sounds. The coast of Florida is dually affected by the strong Gulf Current that sweeps northward close to shore (See Figure 39 and 40).

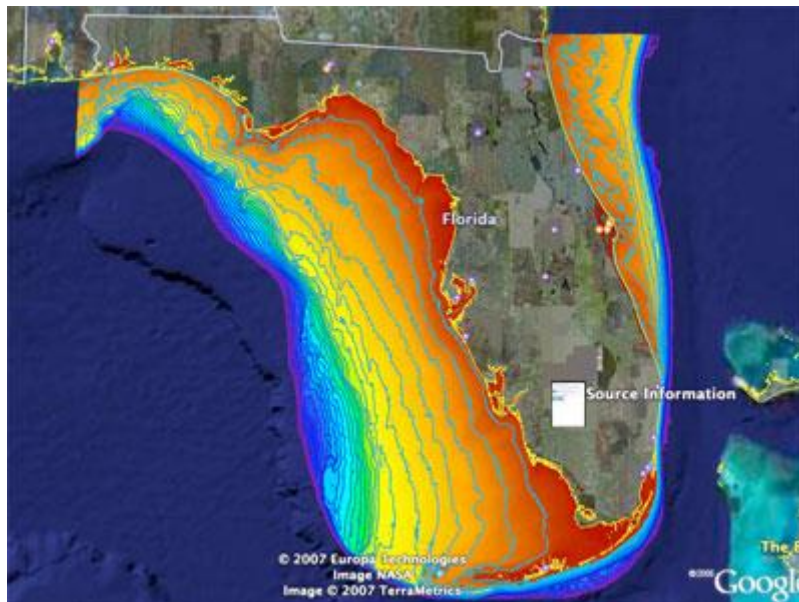

FIGURE 39. Bathymetric Map of Water surrounding Florida. Red demarcates the most shallow, blue the deepest (USGS, 2007).

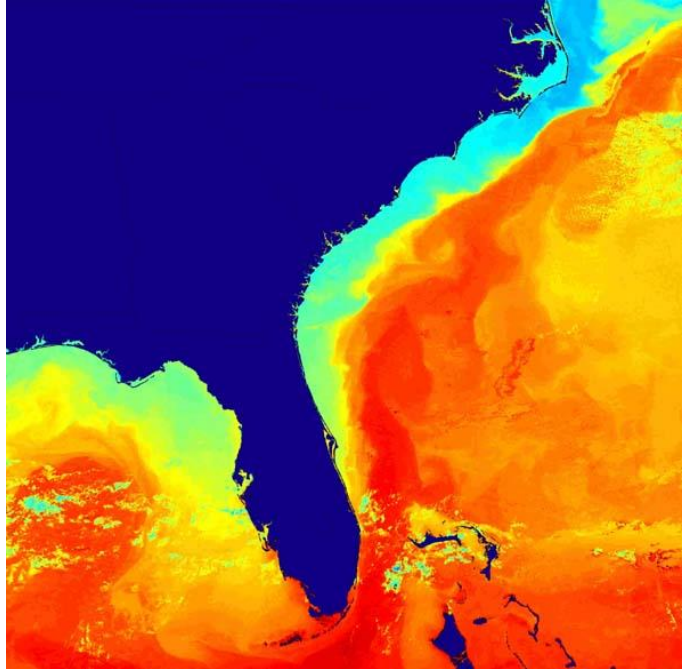

FIGURE 40. Map showing the Gulf Stream and its proximity to the Florida Coast. Gulf Stream can be identified by the dark red swirl sweeping around the peninsula and up the coast (NOAA, 2010).

The sharpie, *Skiperee*, turned out to be a huge success on the coast of Florida, being able to easily maneuver the shallow shoals surrounding the shore and was sturdy enough to handle the strong currents of the Gulf Stream. In 1883, Munroe designed the Kingfish, a 33 foot sharpie which he rigged with a gaff ketch and sprit booms (See Figure 41).



FIGURE 41. *Kingfish* (History of Miami, 1903)

The continued success of the sharpie in the waters of Florida led to the continuation and expansion of designs for Florida sharpies. The market quickly expanded and the sharpie became a popular sight off the coast of Florida in the late 19th century. In 1886, Munroe designed the double ended sharpie, *Egret*, specifically designed to maneuver in the Florida inlets and maneuver in the swift Gulf currents. The *Egret* was one of a kind, a sort of hybrid of the best characteristics of a dory and a sharpie (See Figures 42 and 43). The vessel had a deep, narrow bottom and flaring topsides. This vessel drew only 8 inches of water and could handle almost any weather, but if not, could easily be pulled ashore without risking damage (Parker 2007:20).



FIGURE 42. Photo of the *Egret* at sail. Note how close to shore she was sailing with no trouble, a testament to her extremely shallow draft and easy maneuvering with her unusual batton sails (Munroe 1886).



FIGURE 43. Drawing of the Egret. Note the definitive characteristics of the vessel: movable centerboard, narrow hull, shallow draft, and balanced rudder (Garant 2002).

Small sharpies, 18-22 ft long, became highly popular in the Florida area, but not for the traditional task of oystering. They were predominantly used for fishing, sponging, mail transport, cargo, passenger transport, and survey work. There was an array of different rigs employed on these vessels, mostly dependent on individual preferences. Many were known to use schooner rigs but there were many variations on it. In 1894, the Cedar Keys sharpie was introduced which was much larger than most and rigged as gaff cat boats (Parker 2007:21). Sharpies maintained a position in the Florida waters well into the twentieth century. Once again because of their proven effectiveness, versatility, and cost effectiveness.

The Great Lakes sharpies and the Florida sharpies could both have feasibly been contained in the original batch of research constituents along with the New Haven, the Chesapeake and the Carolina Sound sharpies. However, this researcher felt that the variances in these particular two variants were too far from the average to produce an accurate comparison. Although the Florida and Great Lakes sharpies bear the same name and share some characteristics with research subjects, they are outliers, or subjects that lie so far outside of the normal region it will inaccurately skew the results. Because these two sharpie types were influenced by either significantly different time periods or by significantly different geographic areas, they cannot be effectively lumped into the comparisons that this particular research is striving to explore.

Chapter 7

Conclusion

Environments

The environments of New Haven, Chesapeake, and North Carolina are all unique but also bear similarities. It is these similarities and differences that catalyzed many of the changes to the sharpie vessel design as it moved down the east coast of the United States. Clearly, each of these environments is an inter-coastal, tidal environment that is characterized by ocean access through inlets, bays, sounds, and rivers. All of the locales have rich intertidal zones dominated by shallow, brackish waters that provide ideal conditions for the propagation of oysters and other marine invertebrates. All locales are dominated by the currents of the Gulf Stream circling from the south to combine with the colder waters of the Labrador currents near Canada. In summary, the east coast of the United States is a temperate but nutrient rich marine environment.

The environmental factor that makes the biggest difference in the case of the sharpie design alterations is the degree of physical protection afforded to each area. Both the Long Island Sound and the coast of North Carolina are highly protected by physical barriers, Long Island and the Outer Banks respectively, protect these environments from the worst conditions of the open ocean. The Chesapeake Bay, though partially protected, is much less sheltered and, therefore, more vulnerable to conditions of the open ocean. In addition, the Chesapeake Bay is significantly deeper, in general, than either the Long Island Sound or the Bogue Sound of North Carolina. The combination of increased depth and exposure to ocean conditions creates a much harsher and rougher environment in the Chesapeake Bay.

Economy

The economy of each of these areas played an integral part in the development and spread of the sharpie vessel type. All three economies were experiencing some sort of upheaval when the sharpie became a popular mode of transportation and a venue for livelihood. The New Haven area was experiencing a shift from a dominantly agricultural society to a more industrial society. As the land was depleted of nutrients and large timber supply, people began looking for new ways to support themselves while building traditional watercraft in new, more cost effective ways. This economic transition spurred the need for a cheaply built vessel that still fit the needs of the oystermen on the Long Island Sound, which catalyzed the development of the sharpie.

Similarly, the Chesapeake Bay was going through an economic transition, though for a different reason. After the Civil War, the Southern economy was in shambles as the traditional plantation system supported by slave labor broke down. As the South strove to rebuild, there was a need for a cheap reliable vessel that could perform in the Chesapeake Bay to support the thriving oyster business. As one of the few industries that not only survived but was actually flourishing in the South, oystering commanded a need for a stable, cheap vessel.

Finally, the coast of North Carolina was similarly recovering from the Civil War, much like the Chesapeake Bay. Less affected economically by the war than much of the rest of the South, the foremost issue with the Outer Banks was a lack of accessibility to the mainland. This created a huge obstacle for the oystering businesses in the sounds. However, improvements in canning machine technology increased the amount of time that the previously perishable oysters could keep, expanding the markets throughout the country. Expanded market necessitated the employ of a cheap and versatile vessel, both for oystering and for goods transport.

Transitional Forms

The transitional forms of the sharpie vessel in each area are reflective of the individual needs of each area. Many of these transitional forms existed at the same time and were a combination of multiple types of hybrids. Though one of the fascinating aspects of the sharpie, this also makes many of these transitional forms difficult to classify. However, within each of these trials and errors lay an example of human ingenuity and cultural influence. By studying these transitional forms, it also allows for the merging of new ideas and older traditional practices to be analyzed and examined. Transitional forms of the sharpie vessel, like the flat iron skiff or the Hampton flattie, demonstrate the individual spheres of influence their vessels were designed for.

Sharpie Forms

Each of the three areas discussed had a style of sharpie that was clearly adapted to fit the specific needs of each area. The New Haven sharpie was a smaller boat generally 25-27 feet and later 35-40 feet at the largest, designed to be manned by two men. Shallow drafted with a movable centerboard and highly maneuverable, the New Haven sharpie was perfectly suited for the needs of the New Haven area at the time. The New Haven sharpie was particularly successful because of the economy shifting from agriculture to industry, a lack of large timber, increased use of saw mills, shallow coastal environment, and the depletion of near shore oyster beds.

The Chesapeake Bay sharpie has a more complicated, convoluted history. The Chesapeake Bay sharpies were employed during a time of aggressive experimentation with many different forms of sharpies and sharpie-like vessels. Eventually, the sharpie descendant, the skipjack, came to dominate the Chesapeake Bay. Regardless of the name, the Chesapeake Bay

sharpie vessels shared a few key characteristics such as a V-bottom hull, much larger size, and much greater displacement than its New Haven predecessors. Still cheap to construct and easy to build, these sharpie forms were a common sight on the waters of the Chesapeake. The altered sharpie forms were popular in the Chesapeake mainly because of the deeper, rougher water, longer distance to market, the disintegration of plantation based agriculture, and mechanized canning.

The North Carolina sharpies were more similar to their New Haven ancestors, as the environments in the Long Island Sound and the Bogue and Pamlico Sounds are very similar. The North Carolina sharpies, their ultimate form referred to as Core Sound sharpies, were categorized by a very large size, schooner gaff rigging, wider girth, and flat bottoms. As time progressed, more efficient ways for oystering became available and in the early 1900's, the sharpies became used more for transportation and efficient delivery rather than oystering. The term sharpie soon came to refer to many different types of vessel types in the North Carolina sound. The sharpie vessel became so prevalent in the North Carolina sounds primarily due to shallow coastal environment, economic cost efficiency, lack of industry, and lack of infrastructure (See Figures 44A, B, and C for Visual Comparison).

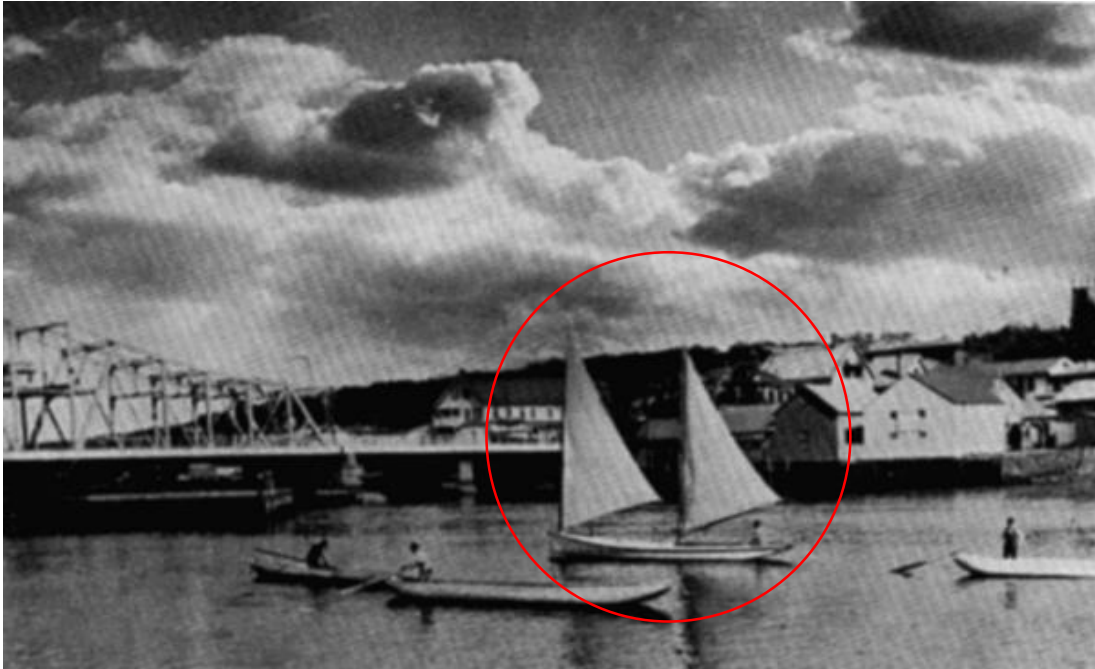

FIGURE 44A. New Haven Sharpe, New Haven, Connecticut, Late 19th century (Chappelle 1951:135)



FIGURE 44B. Skipjacks (Chesapeake Bay most likely) (Mystic Seaport 2007)



FIGURE 44C *Bessie D* under sail in 1912. Built in 1891. Sailing near Smyrna, NC (Core Sound Waterfowl Museum 2010).

Archaeology

Unfortunately the archaeological record is lacking in a broad array of good examples of sharpie vessels. With the notable exception of Vessel #3 excavated by ECU which gave good insight into the design and construction of late North Carolinian sharpies. However, the relative modernity of these vessels provides an opportunity for archaeological researchers that is not generally seen. Since their heyday was a mere hundred years ago, researchers have a plethora of first-hand accounts, descriptions, drawings, designs, and photographs of these vessels.

Additionally, museums such as the Mystic in Connecticut have managed to preserve floating examples of some of these vessels offering a rare and valuable chance to experience these vessels first hand.

Conclusion

By examining the migration of the sharpie vessels and the changes that accompany each of these transitions a wealth of information can be gained. Not only does each of these transitions provide examples of different designs and construction techniques, but digging a little deeper can demonstrate information about the economics of the culture and the society that is doing the designing and the constructing. By viewing vessel design, construction, and use in a larger sphere in conjunction with the culture, economy, and the environment, reveals the reasons behind these alterations. By understanding motivations and reasons, a researcher can gain a larger and more thorough understanding of the culture and its people.

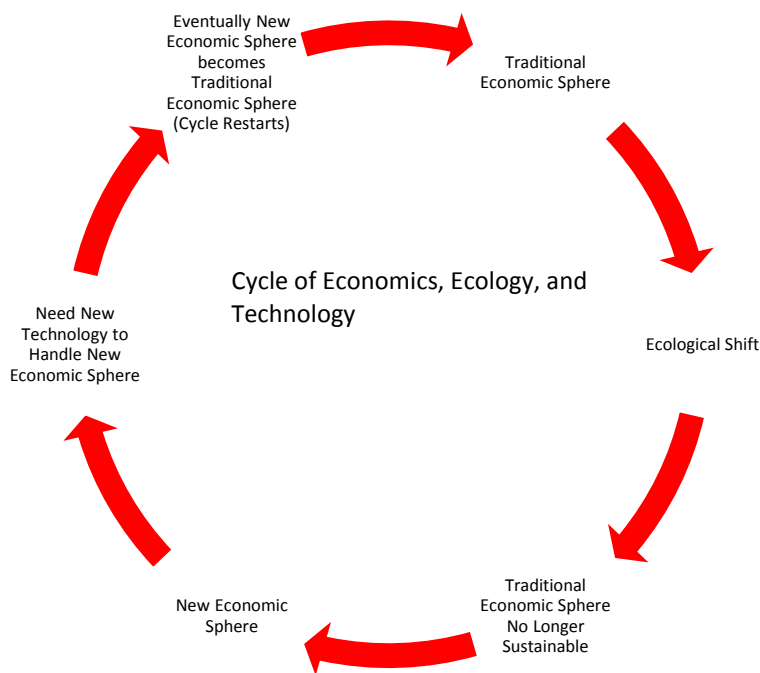

FIGURE 45. Cycle of Economics, Ecology, and Technology

The evolution of the sharpie is an excellent example of how archaeology can represent larger paradigm shifts with in a culture, or in other words, how artifacts reflect the culture they

belonged to. The changes in the sharpie directly mirror the shifts in economy, ecology, and technology. The established economic venue had become unsustainable due to ecological factors (See Figure 45). This ecological change, prompted by the old, unsustainable economic sphere, led to the development of the new economic sphere. In order to accomplish the development of a new economic sphere, new technology had to be developed.

A specific example of this cycle lies within the development and the evolution of the sharpie. For example, the New Haven area's traditional economic sphere, farming, became unsustainable due to ecological factors, notably lack of soil nutrients (See Figure 46). The infertility of the soil, prompted the people to look for a new economic sphere, the fisheries and oyster beds of the Long Island Sound. In order to utilize this new economic sphere, new technology was needed, hence the development of the highly specialized sharpie vessel.

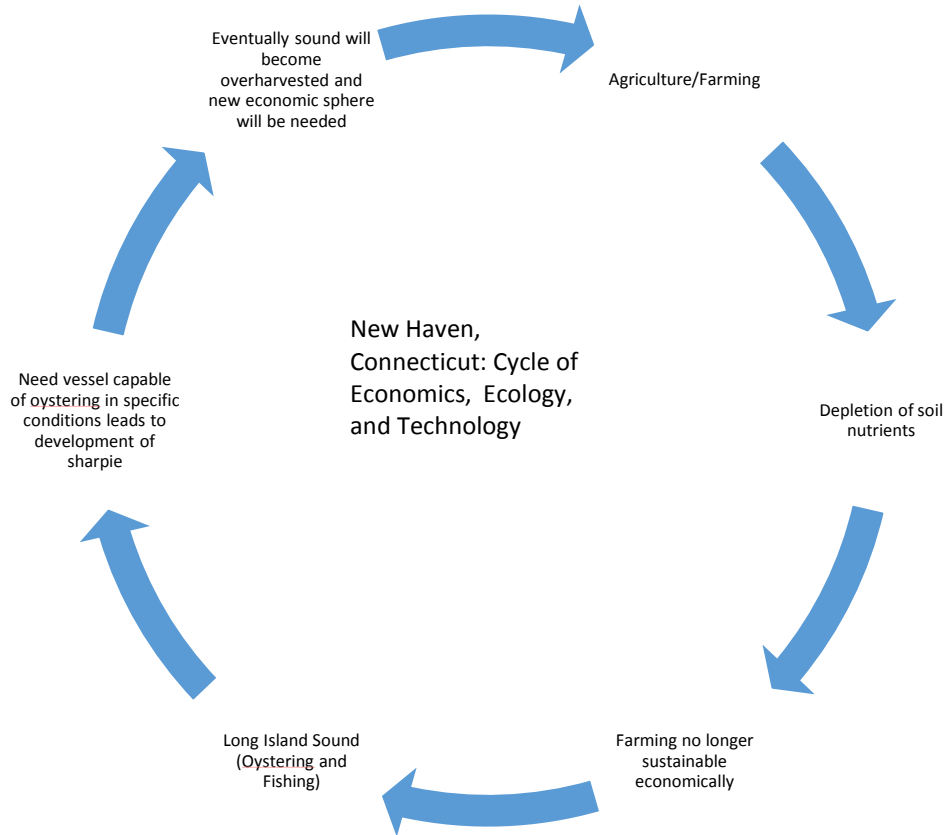

FIGURE 46. New Haven, Connecticut: Cycle of Economics, Ecology, and Technology

The Chesapeake Bay bore a similar pattern when looked at it its simplest form. The traditional economic sphere, local near shore fishing and oystering, was no longer viable because of an ecological factor, the depletion of near shore oyster beds. This ecological change prompted an economic shift to high volume deeper water fishing and oystering, which necessitated new technology. The demands of working in the new economic sphere of high volume deep water oyster prompted the development of the Chesapeake Bay sharpie forms that could accommodate the needs of the new economic sphere.

Once again we see the pattern emerge in the sounds of North Carolina. Though different from New Haven and Chesapeake, the pattern is still recognizable in North Carolina. The

traditional economic sphere of local, individualized oystering was no longer a sustainable, profitable option due to the ecological factors of topographical isolation. This ecological factor prompted an economic shift into higher volume oystering which necessitated the new technology of the sound sharpies to accommodate the changes.

Of course, these examples are incredibly simplified. Each of the aforementioned situations had dozens, if not hundreds, of intricately interwoven economic, ecological, political, and cultural factors that combined to create the situations and their subsequent outcomes. But at the basis of these transformations are consistent factors that are reflected through the use of artifacts, such as the sharpie.

This pattern can be seen time and again in history and herein lies the secret why archaeology remains a relevant study. Artifacts reflect culture and cultural change. Artifacts, such as the sharpie, tell the story of a culture, its changes, and its development. By studying these artifacts, their construction, their usage, their styles, and their histories archaeologists have the ability to look beyond the written word of the historical record and ascertain those things that weren't written down but can give invaluable insight into the past. The sharpie vessel, in all its forms, is most importantly a reflection of those who built, sailed, and used them.

Bibliography

1879 *Forest and Stream; A Journal of Outdoor Life, Travel, Nature Study, Shooting, Fishing, Yachting* (1873-1930) 11:486.

2002 North Carolina Business History: *Overview of NC Business Development*. Accessed online at www.historync.org

2009 Photo of New Haven Yacht Club. Accessed 2014 at <http://www.newhavenyc.org/pages/images/history/Sharpie.aspx>

Burgess, Robert H.
1975 *Chesapeake Sailing Craft Part 1*. Tidewater Publishers, Maryland.

Chapelle, Howard Ijkb
1951 *American Small Sailing Craft: Their Design, Development, and Construction*. W.W. Norton & Company, Inc., New York.

Chapelle, Howard I
2009 *The Migrations of An American Boat Type*. Naval Press, Maryland.

Chesapeake Bay Maritime Museum
2014. Plan of Chapelle's Seaside Bateaux 13 foot, one sail. Accessed online through collection at www.cbmm.org. October 2014.

Coker, Robert Ervin
1905 *Oyster Culture in North Carolina*. EM Uzzell & Co, Raleigh.

Core Sound Waterfowl Museum
2010 *Bessie D* under sail in 1912. Clarice W. Willis Collection, Core Sound Waterfowl Museum Harkers Island NC. Accessed online at <http://coresound.com/>. October 2014.

Desmond, Charles
1998 *Wooden Ship Building*. Vestal Press Inc, Maryland.

Durham, George
1955 *Canoes from Cedar Logs: A Study of Types and Designs*. Pacific Northwest Quarterly, Seattle.

Fisheries Commission (US)
1887 *Fisheries Commission Report. Picture of Erie Pound Net*. Accessed online <http://forum.woodenboat.com/showthread.php?165651-Advice-on-building-a-historic-sharpie> .
2014.

- Fleetwood, William C
1995 *Tidecraft: The Boats of South Carolina, Georgia, and North eastern Florida-1550-1950*. WBG Marine Press, Georgia.
- Friedman, Milton
1953 "The Methodology of Positive Economics": *Essays in Positive Economics*. Chicago University Press, Chicago, pp 3-43.
- Garant, Patrick
2002 *Diagram of Commodore Munroe's Egret*. Les Sharpies. Accessed online at <http://www.mandragore2.net/dico/lexique2/lexique2.php?page=sharpie>. October 2014.
- Getchiss, Tessa, Lawrence Williams, Alfred May
2006 *Seed Oystering*. University of Connecticut, Connecticut.
- Glaser, Leah S.
2014 *Dynamic Tensions: Conservation and Development up to the 1920s*. Connecticut Humanities. Accessed online at www.connecticuthistory.org
- Hanes, Samuel P.
2013 *Common Property mapping and the preservation of traditional rights in the Chesapeake Bay's Oyster Fishery, 1892-1914*. *Journal of Cultural Geography*. 30:3, 308-327.
- Hargis, William and Dexter Haven
1999 *Chesapeake Oyster Reefs, Their Importance, Destruction and Guidelines for Restoring Them*. Virginia Institute of Marine Science Press, Virginia. Accessed online 2014.
- Harman, John
2014. Use and Composition of an Oyster Dredge. Simply Whistable Co. Accessed online at <http://www.simplywhistable.com/oysterdredging/oysterdredge/oysterdredge.html>. October 2014.
- History of Miami
2014 of the Kingfish at Sail, Courtesy of the History of Miami Foundation. Accessed online at <http://historymiami.mycapture.com/mycapture/enlarge.asp?image=48378928&event=1691260&CategoryID=78837>
- Kemp, Peter
1978 *The History of Ships*. MacDonald & Co, UK.
- Kerber, Jordan E.
1991 *Coastal and Maritime Archaeology: A Bibliography*. The Scarecrow Press, Inc., Metuchen, New Jersey, London.

Kunhardt, C. P

1889 *Small Yachts: Their Design and Construction exemplified by the Ruling Types of Modern Practice*. WoodenBoat Publications, Inc., Maine.

Leshner, Pete

1992 *A Heritage in Wood: A Catalogue of the Museum's Historic Wooden Boat Collection*. Chesapeake Bay Museum, Maryland.

Lewis, JD

2007 *Overview of the 1800s in North Carolina*. Little River, SC. Accessed online at www.carolana.org

MacGregor, David R

1997 *The Schooner, Its Design and Development from 1600 to the Present*. Naval Institute Press, Annapolis.

Mariners Museum

2011. *Log Canoe*. Mariners Museum, Maryland. Accessed online at www.marinersmuseum.org

2011. Drawing of Oyster Tongs. Originally from text: *The History and Present Condition of the Fishery Industries, The Oyster Industry, 1881*. Accessed online at www.marinersmuseum.org

2014. The bugeye *JC Armiger* (circa 1890) Maryland. Accessed through online archives at www.marinersmuseum.org. October 2014.

2014. Early oyster dredger illustration. Mariners Museum, Maryland. Originally from *The Oyster Industry* by Ernest Ingersoll. Accessed online at www.marinersmuseum.org. September 2014.

2002. Oyster dredger in use in Chesapeake Bay. Mariners Museum, Maryland. Accessed online at www.marinersmuseum.org. October 2014.

Matthews, Frederick C

1930 *American Merchant Ships 1850-1900 Series 1*. Dover Publications, Inc., New York.

McDonnell, Jim

2013 "Oyster, Eastern." *Map of Distribution of *Cassostrea virginica**. Accessed Online at <http://www.jjmcdonnell.com/images/products/global-supply-map-oyster-eastern.jpg?Action=thumbnail&Width=506>.

Mifflin, Houghton

1996 *Canoes: Encyclopedia of North American Indians*. www.search.credoreference.com
Accessed May 2014.

Mott, Lawrence V.

1997 *The Development of the Rudder: Technological Tale*. Texas A&M University Press, College Station.

Munroe, Ralph

1886 Photo of the Egret at Sail. Accessed online at <http://boat.waywood.co.uk/haiku/>. October 2014.

Mystic Seaport

2014 *New Haven Sharpie: Oyster Tonger*. Mystic Seaport, Connecticut. Accessed online at www.mysticseaport.org. May 2014.

2014. St. Michael's Regatta 1928. Mystic Seaport, Connecticut. Original image Rosenfield and Sons 1928. Accessed online at www.mysticseaport.org. September 2014.

2014. Yawl rigged yacht off coast of New Haven, Connecticut circa 1900 photo. Accessed online at www.mysticseaport.org. September 2014.

National Canners Association

1959 *The canning industry, its history, importance, organization, methods, and the public service values of its products*. Washington Information Division, Washington DC.

NYHC (New Haven Yacht Club)

2009 Photo of *Isabel*, a sharpie off Savin Rock, Connecticut, mid 19th century. NYHC. Accessed online at <http://www.newhavenyc.org/pages/images/history/Sharpie.aspx>. September 2014.

North Carolina Maritime Museum

2014. Assort Images. North Carolina Maritime Museum. Beaufort, NC.

Images: 78.086.038c, 86.105.027, 78.052.039, 86.105.2951, 83.001.002, 78.065.039, 78.060.039, A-4834

North Carolina State Archives

2014. Assorted Images accessed through the North Carolina Maritime Museum in Beaufort NC

Images: 86.105.2949, 86.105.2950, 86.105.018, 86.105.020, 86.105.2246, 86.105.213, 86.105.233

NOAA

2007 Topographic Map of Virginia Beach. NOAA. Accessed online 2014 at <http://www.noaaneews.noaa.gov/stories2007/images/virginia-beach-dem-map2.jpg>

2007 Bathymetry Map of the Chesapeake Bay. Accessed online at

<http://www.virginiaplaces.org/chesbay/>. May 2014.

2009. Bathymetric Map of Waterways feeding into the Chesapeake Bay. Accessed online at

<http://clasticdetritus.com/2009/05/02/sea-floor-sunday-46-chesapeake-bay/>. June 2014.

2007. Bathymetric Map of Coastal NC. Accessed online at

<http://www.gearthblog.com/images/images107/noaa.jpg>. June 2014.

2014 Bathymetric Map of Lake Erie Accessed online at https://www.ngdc.noaa.gov/mgg/greatlakes/lakeerie_cdrom/html/e_gmorph.htm
2012 Bathymetric Map of Gulf Stream Accessed online at http://oceanexplorer.noaa.gov/explorations/islands01/background/islands/sup11_bump.html.
Nov 2014.

Oral History Interview with John Thomas (OH 67-7). Interviewer: John Kochiss. July 20,1967.
Accessed online at www.mysticseaport.org

Parker, Reuel
2007 *The Sharpie Book*. The International Marine Publishing, Maine.

Pelton, Tom, Bill Goldsborough
2010 *On the Brink: Chesapeake's Native Oysters, What it will take to bring them back*.
Chesapeake Bay Foundation, Maryland. Accessed online 2014.

Poquoson Historical Society
1991 *An Unusual Watercraft: The Poquoson Sailing Log Canoe*. The Society, Virginia.

Puglisi, Melany
2008 *Crassostrea virginica*, Journal of Shellfish Research 24:157-165. St Lucie Estuary

Rand, Henry L
1890 Photo of Higgins Saw Mill Somesville. Maine Memory Network. Accessed online 2014 at <http://www.historybyzim.com/tag/united-states/>.

Roberts, Tad
2014 *Illustration of Gaff Rigged Sloop*. Wooden Boat Forum. Accessed online at <http://forum.woodenboat.com/archive/index.php/t-58052.html>. 2014.

Rodgers, Bradley and Nathan Richards
2000 *The Castle Island Ships' Graveyard: The History and Archaeology of Eleven Wrecked and Abandoned Watercraft*. Program in Maritime Studies ECU, NC.

Smith, Donald
2004 *The History of Connecticut's Forest Land*. The Connecticut Statewide Forest Rescue Plan 2004-2013. Division of Forestry, CT. Accessed online at www.ct.gov

Steward, Robert M.
1959 *Small Boat Construction*. The Rudder Publishing Co., New York.

Stick, David
1983 *Indian Canoes in coastal North Carolina 400 Years ago*. Accessed online at www.nps.gov/fora.com

Sucher, Harry V.

1973 *Simplified boatbuilding: the flat-bottom boat*. WW Norton & Co.

US Army Corps of Engineers

2014 Map of Great Lakes Accessed online at

http://www.michigan.gov/deq/0,4561,7-135-3313_3677-15926--,00.html

USGS

2013 *Bathymetric Map of Long Island Sound*. USGS Accessed online at

<http://woodshole.er.usgs.gov/project-pages/longislandsound/data/bathydata.htm>

2007 *Bathymetric Map of Florida*. USGS Accessed online at

<http://coastal.er.usgs.gov/flash/summary.html>

Volmar, Mike

2006 *The Dugout Canoe Project*. Fruitland's Museum, Massachusetts. Accessed online at

www.fruitlands.org

Walbert, David

2013 *Industrialization in North Carolina*. NC Digital History, UNC School of ED. Accessed online at www.learnnc.org

APPENDIX 1. TABLES OF SAMPLE SHARPIE DIMENSIONS

TABLE 1. DIMENSIONS OF A 54 FT SHARPIE

Length Overall	60 ft
Beam Extreme	14 ft
Least freeboard	2.5 ft
Draft w/out board	20 in
Draft w board	8 ft
Length of board	16 ft

TABLE 2. DIMENSIONS OF OPEN NEW HAVEN SHARPIE (ROUND STERN)

Length overall	36 ft 1 in
Beam on bottom	6 ft 3 in
Beam on top	7 ft
draft	6.5 in
Centerboard	10.5 ft and 5 ft wide aft

TABLE 3. DIMENSIONS OF AN IMPROVED SHARPIE

Length overall	45 ft
Beam	11 ft 6 in
Centerboard	15 ft long
Draft (Centerboard up)	12 to 15 in

TABLE 4. DIMENSIONS OF CARRIE V (RACING SHARPIE BY LESTER ROWE)

Length	35 ft
Breadth	8 ft on deck
Centerboard	11 ft
Length of rudder	6 ft and 18 in deep
Draft	6 in
Washboards	12 in wide amidships
Width of Stern	4.5 ft

TABLE 5. GENERAL SHARPIE DIMENSIONS BY KUNHARDT

Length overall	15 ft	20 ft	25 ft	35 ft
Length on waterline	13 ft	17 ft	22 ft	30 ft
Greatest width across deck	4 ft	5 ft	6 ft	9 ft
Greatest width across floor	3.6 ft	4.3 ft	4.9 ft	7 ft
Depth amidships	1.2 ft	1.3 ft	1.6 ft	2.6 ft
Draft w/out board	4 in	6 in	9 in	1 ft
Foremast	18 ft	23 ft	29 ft	39 ft
Luff of foresail	16 ft	21 ft	26 ft	36 ft
Foot of foresail	6 ft	10 ft	13 ft	18 ft
mainmast	-----	22 ft	27 ft	38 ft
Luff of mainsail	-----	20 ft	25 ft	35 ft
Foot of mainsail	-----	10 ft	12 ft	17 ft
Length of centerboard	5 ft	7 ft	9 ft	11 ft

(Kunhardt 1889:209-219)

APPENDIX 2. ADDITIONAL PHOTOS OF SHARPIES

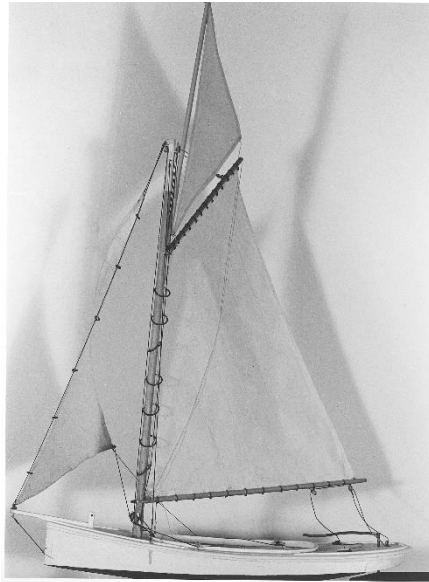

FIGURE 2.1. North Carolina sharpie model port view (Image 86.105.2951) (Courtesy of the North Carolina Maritime Museum in Beaufort 2014)



FIGURE 2.2. *Three Samuels*, Sharpie schooner built 1889 in Beaufort NC (Image 83.001.002) (Courtesy of the North Carolina Maritime Museum Beaufort 2014)

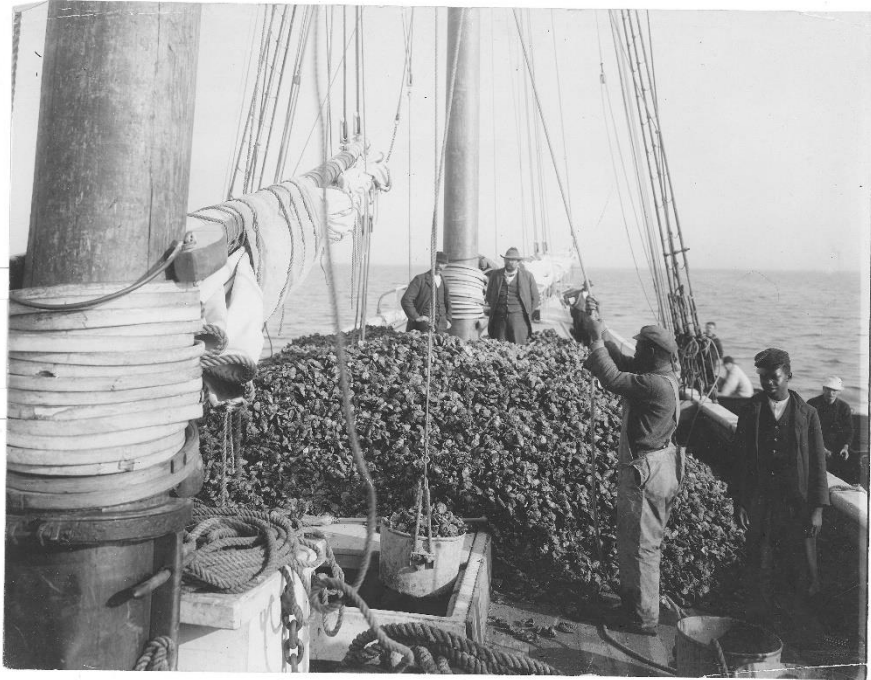

FIGURE 2.3. Oystering, 1884, Washington, Beaufort County NC (Image 78.065.039) (Courtesy of the North Carolina Maritime Museum Beaufort 2014)

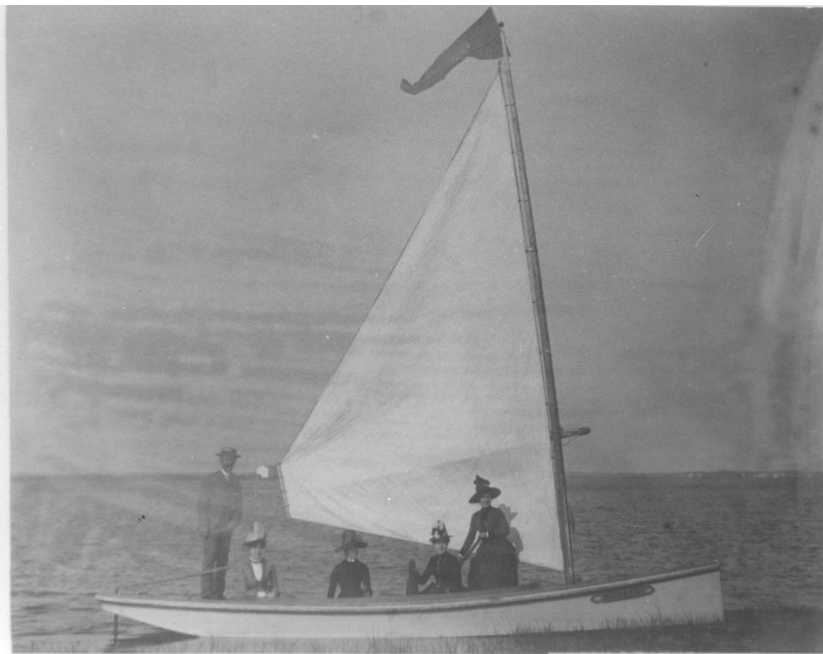

FIGURE 2.4. Sharpie in Beaufort Harbor 1910 (Image 86.105.2246) (Courtesy of the North Carolina State Archives 2014)



FIGURE 2.5. Core Sound Sharpie (Image 86.105.213) (Courtesy of North Carolina State Archives 2014)



FIGURE 2.6. Oyster sharpie off Marshallburg, Carteret County (Image78.060.039) (Courtesy of the North Carolina Maritime Museum Beaufort 2014)

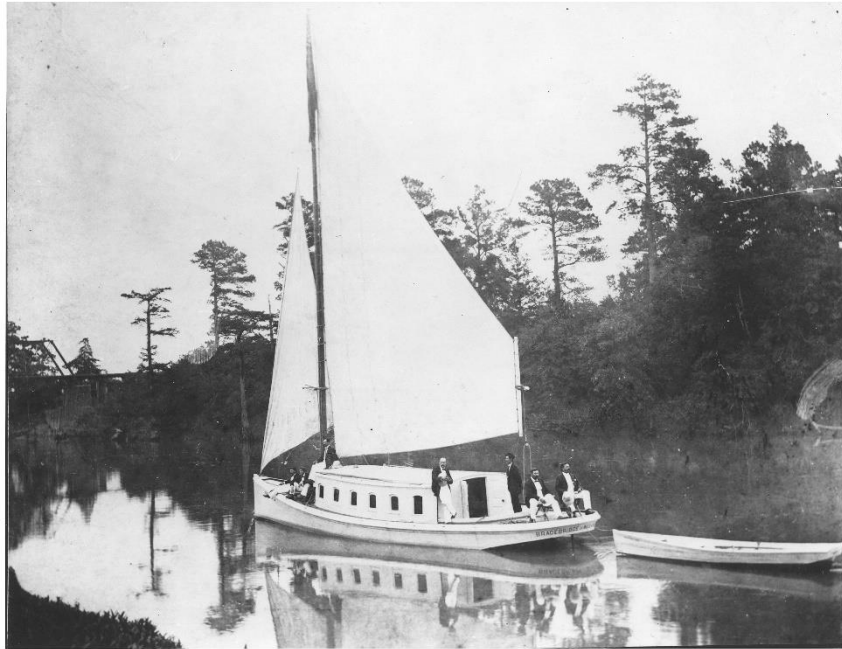

FIGURE 2.7. *Bracebridge*, sharpie sloop on Tar River (Image 86.105.233) (Courtesy of North Carolina State Archives 2014)

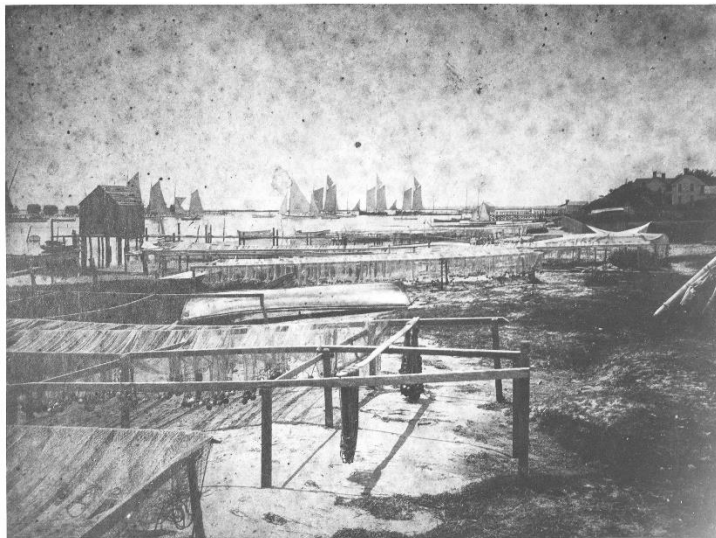

FIGURE 2.8. Sailboats on Taylor Creek with Drying Nets, ca 1895 (Image A-4834) (Courtesy of North Carolina Maritime Museum Beaufort 2014)